

**SEIKO**

QUARTZ *LC*

**Cal.M159A**

**PARTS LIST**

Calibre No.

**M159A**

Style Name

**QUARTZ LC  
CHRONOGRAPH**

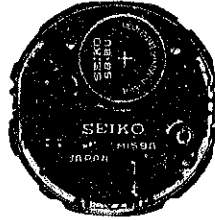
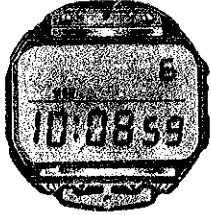

**Characteristics**

Casing diameter :  $\phi$  27.0 mm  
 Maximum height : 6.1 mm  
 Frequency of quartz crystal oscillator : 32,768 Hz  
 (Hz : Hertz . . . . . Cycle per second)  
 Time and calendar functions :  
 Digital Display System showing hour, minute, second, date and day  
 Stopwatch functions :  
 20-hour Digital Display System showing hour, minute, second, 1 : 10 second and LAP-STOP indication  
 Time micro-adjustor : Trimmer condenser system  
 Illumination light for digital display panel :  
 Illuminated in coordination with the touch-button depressing



354 940



354 941



383 940



389 940

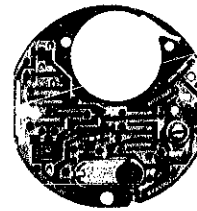

400 940

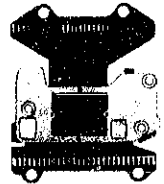

4007 941



4032 940



4050 941



4219 940



4242 941



4256 940



4270 940

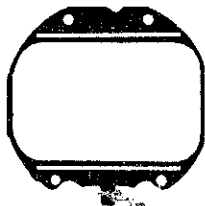

4313 940

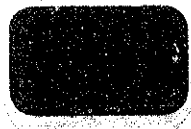

4398 940

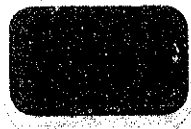

4510 940



4521 940



4540 940



4540 941



SEIKO SB-BU

v	#	=	
022 256	023 061	023 067	2/1

Calibre No.		Style Name	
<b>M159A</b>		<b>QUARTZ LC CHRONOGRAPH</b>	
PART NO.	PART NAME	PART NO.	PART NAME
<b>354 940</b>	Stem (Short)		
<b>354 941</b>	Stem (Long)		
<b>383 940</b>	Setting lever		
<b>389 940</b>	Setting lever axle spring		
<b>4009 940</b>	Crystal oscillator block		
<b>4007 941</b>	LSI block		
<b>4032 940</b>	Bulb		
<b>4050 941</b>	Circuit bridge plate		
<b>4219 940</b>	Insulator for battery connection		
<b>4242 941</b>	Plus terminal of battery connection		
<b>4256 940</b>	Crystal holding spring		
<b>4270 940</b>	Battery connection		
<b>4313 940</b>	Connector		
<b>4398 940</b>	Liquid crystal panel guard		
<b>4510 940</b>	Liquid crystal panel		
<b>4521 940</b>	Reflecting mirror		
<b>4540 940</b>	Spring for liquid crystal panel A		
<b>4540 941</b>	Spring for liquid crystal panel B		
<b>022 256</b>	LSI block screw		
<b>022 256</b>	Bulb holding screw		
<b>022 256</b>	Liquid crystal panel holder screw		
<b>022 256</b>	Circuit bridge plate screw		
<b>022 256</b>	Setting lever axle spring screw		
<b>022 256</b>	Circuit block screw		
<b>023 061</b>	Battery connection pin		
<b>023 067</b>	Pin for plus terminal of battery connection		
<b>SEIKO SB-BU</b>	Silver oxide battery		

# TECHNICAL GUIDE

## SEIKO DIGITAL QUARTZ

CAL. M159A

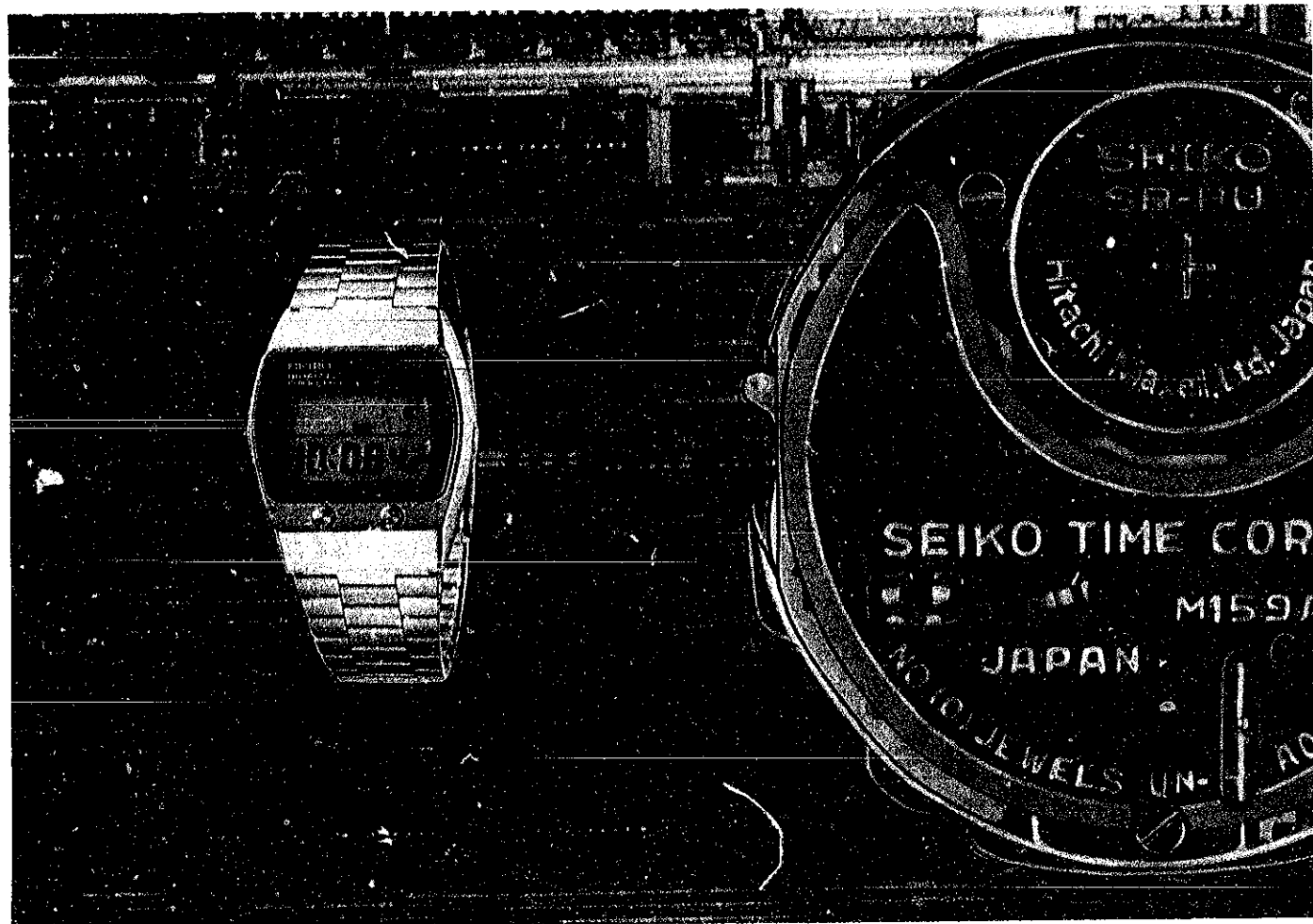

### CONTENTS

	Page
<b>I. SPECIFICATIONS AND FEATURES</b> .....	2
1. Specifications .....	2
2. Features .....	2
<b>II. HOW TO USE</b> .....	3
1. Display .....	3
2. Button operation .....	3
3. How to set the time and calendar .....	3
4. How to use as a stopwatch .....	5
5. Remarks for battery replacement .....	5
<b>III. DISASSEMBLING AND REASSEMBLING</b> .....	6
1. After-sale servicing instruments and materials .....	6
2. Disassembling and reassembling of the case .....	10
3. Disassembling and reassembling of the movement and lubricating of the switch components .....	13
4. Cleaning .....	16
<b>IV. CHECKING AND ADJUSTMENT</b> .....	17
1. Guide table for checking and adjustment .....	17
2. Malfunction and checking points .....	18
3. Relation between segment (Liquid Crystal Panel Electrode) and C-MOS-LSI output terminal .....	19
4. Procedures for checking and adjustment .....	20
A. Check battery voltage .....	20
B. Check conductivity of liquid crystal panel, LSI block and crystal oscillator block .....	21
C. Check liquid crystal panel, LSI block and crystal oscillator block .....	22
D. Check current consumption .....	23
E. Check accuracy .....	24
F. Check adjustment and functioning .....	24
G. Check bulb condition .....	24
H. Check conductivity of switch components .....	25
• Time accuracy adjusting .....	26

Calibre M159A

Movement

Display panel side

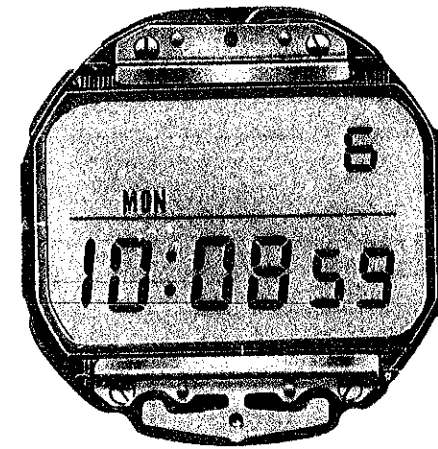

Time and Calendar Function

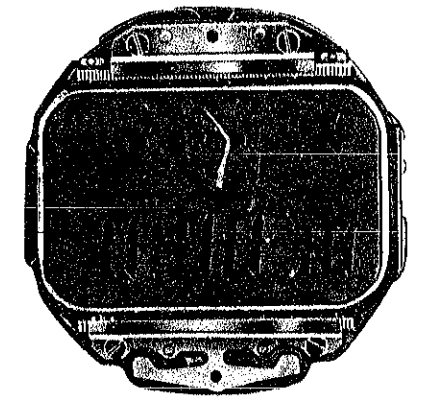

Stopwatch Function

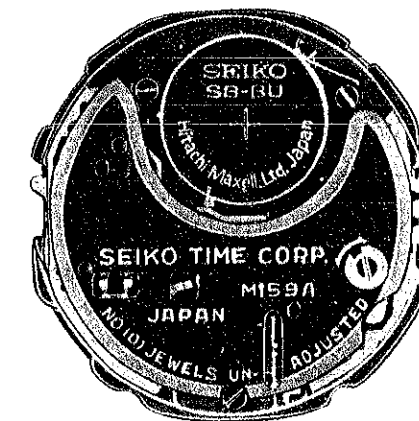

Case back side

# I. SPECIFICATIONS AND FEATURES

## 1. Specifications

Item	Calibre No.	M159A
Display medium		Nematic Liquid Crystal, FEM (Field Effect Mode)
Display system		Two function changeover system <ul style="list-style-type: none"> <li>• Time display: Continuous digital read-out in days, dates, hours, minutes and seconds using FEM (Field Effect Mode) of liquid crystal.</li> <li>• Stopwatch display: Hours, minutes, seconds, 1/10 second and LAP time up to 20 hours using FEM (Field Effect Mode) of liquid crystal. (After 20 hours, measurement starts again from "0" second automatically.)</li> </ul>
Additional mechanism		• Illuminating light
Crystal oscillator		32,768 Hz (Hz = Hertz—Cycle per second)
Loss/gain		Loss/gain at normal temperature range Mean monthly rate: less than 10 seconds Annual rate: less than 2 minutes Temperature compensation device
Casing diameter		φ 27.0 mm
Height		6.1 mm
Operational temperature range		-10°C ~ +60°C (14°F ~ 140°F)
Regulation system		Trimmer condenser
Battery power		SEIKO SB-BU silver oxide battery Battery life is approximately two years.
IC (Integrated Circuit)		C-MOS-LSI . . . 1 piece

## 2. Features

- (1) Simultaneous display of the time and calendar.  
Since the hour, minute, second, date and day are frequently referred to in daily use, all of these indications are displayed at the same time, so that the time and calendar can be read simultaneously.
- (2) Stopwatch accumulating up to 20 hours  
A stopwatch that can accumulate as long as 20 hours and as accurately as up to 1/10 second, has enabled the range of measurable events to be

expanded. Measurement of not only a short distance race requiring an accurate time record but such events covering a long time span as marathon and driving races also have become possible.

- (3) Thin watch  
Despite the watch containing all the necessary chronograph functions, it has been successfully made thinner (the waterproof outer case being 9.0 mm in thickness) with the introduction of a thinner panel and a newly developed module.

# II. HOW TO USE

## 1. Display

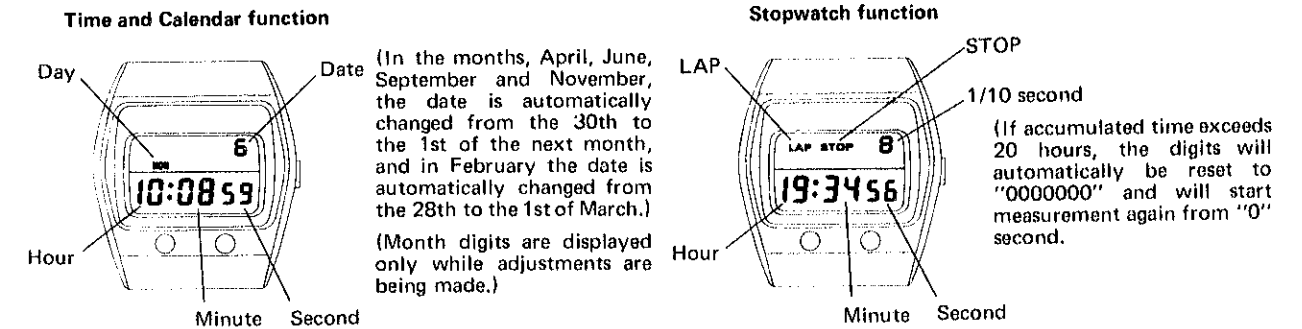

## 2. Button operation

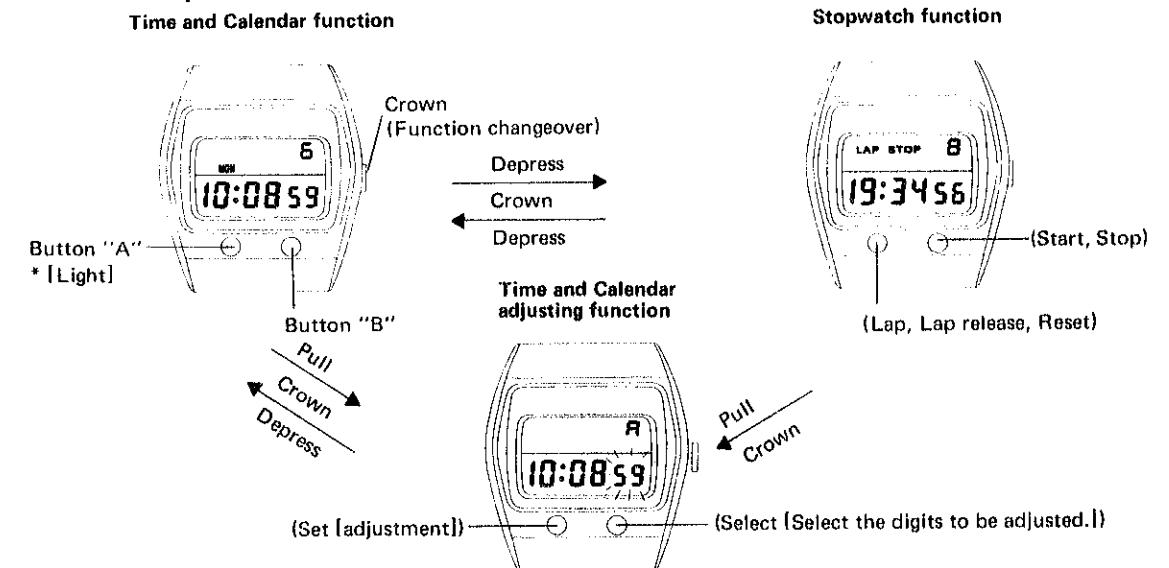

\* **How to use the light (for the time and calendar function)**  
Depress button "A" to activate the illumination light, and the entire display can be read in the dark.

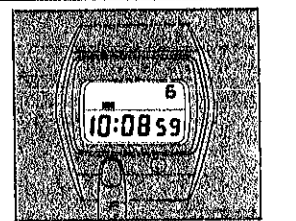

## 3. How to set the time and calendar

- Pull out crown, and the time and calendar digits are ready to be adjusted. This can be done during any function, time and calendar function or stopwatch function, the watch may be performing.
- With crown still in the pulled out position, depress button "B" and the digits (flashing) to be adjusted are displayed cyclically in the order listed below every time it is depressed.
- With crown still in the pulled out position, depress button "A", and the digits to be adjusted (flashing) advance by one digit every time button "A" is depressed. (With crown in the pulled out position, depress button "A", and the second is reset to "00" second.)
- Push in crown and the watch function is set to the time and calendar function no matter which digit is being adjusted.

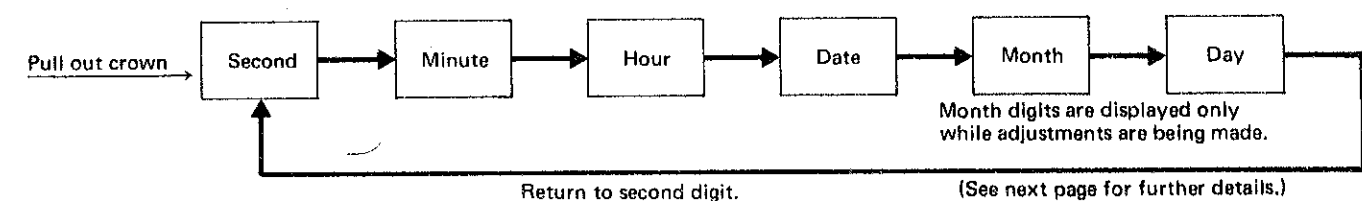

**[EXAMPLE]**

How to change the indication of 10:08:42 AM of May 23 (Sunday) into 7:00:00 PM of June 10 (Friday).

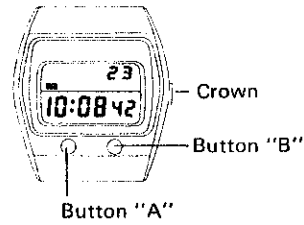

Button operation (Select and set) Digits to be adjusted (in the numerical order)	SELECT (Select the digits to be adjusted)	SET (Digit adjustment)
① Second	Depress button "B", and the digits start flashing. 	Depress button "A", and the flashing digits advance by one digit every time button "A" is depressed. (When the second digits are to be adjusted, depress button "A" and the second will reset to "00".) 
② Minute	"A" (AM) or "P" (PM) is displayed ("A" or "P" is displayed only while the adjustment is being made.)  Pull out crown	Depress button "A" in accordance with the "00" second of a time signal and the seconds are then reset to "00". (When the second counts any numbers from "00" to "29", the seconds are automatically reset to "00". If however, the second counts any numbers from "30" to "59" when button "A" is depressed, one minute is added and the seconds return to "00".) 
③ Hour	Depress button "B" after adjusting the second digits, and the minute digits start flashing. 	Adjust the minute digits. 
④ Date	Be careful not to mistake "A" (AM) for "P" (PM) or vice versa. Always take into account the AM or PM period when setting the watch so that the date can change properly at midnight. 	The display is changed to date, month and day. (Month digits are displayed only while an adjustment is being made.) 
⑤ Month	Day 	Month (For date adjustment only) 
⑥ Day		Depress button "B" again, and the second digits are ready to be adjusted. After all the adjustments are completed, push in crown. 

**4. How to use as a stopwatch**

**(1) Preparation for measurement**

Be sure to start the stopwatch from its reset condition. (All digits must indicate "0" as shown in the illustration on the right.)

**How to reset**

Depress button "B", and "STOP" is indicated. Then, depress button "A" once or twice.

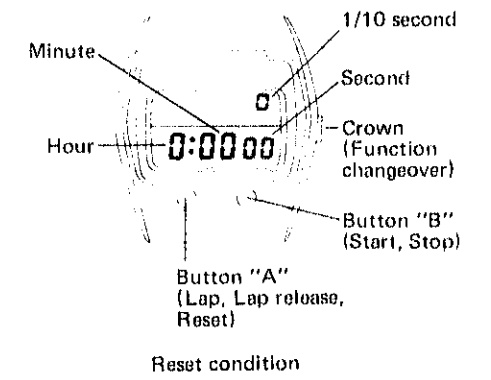

**(2) How to measure**

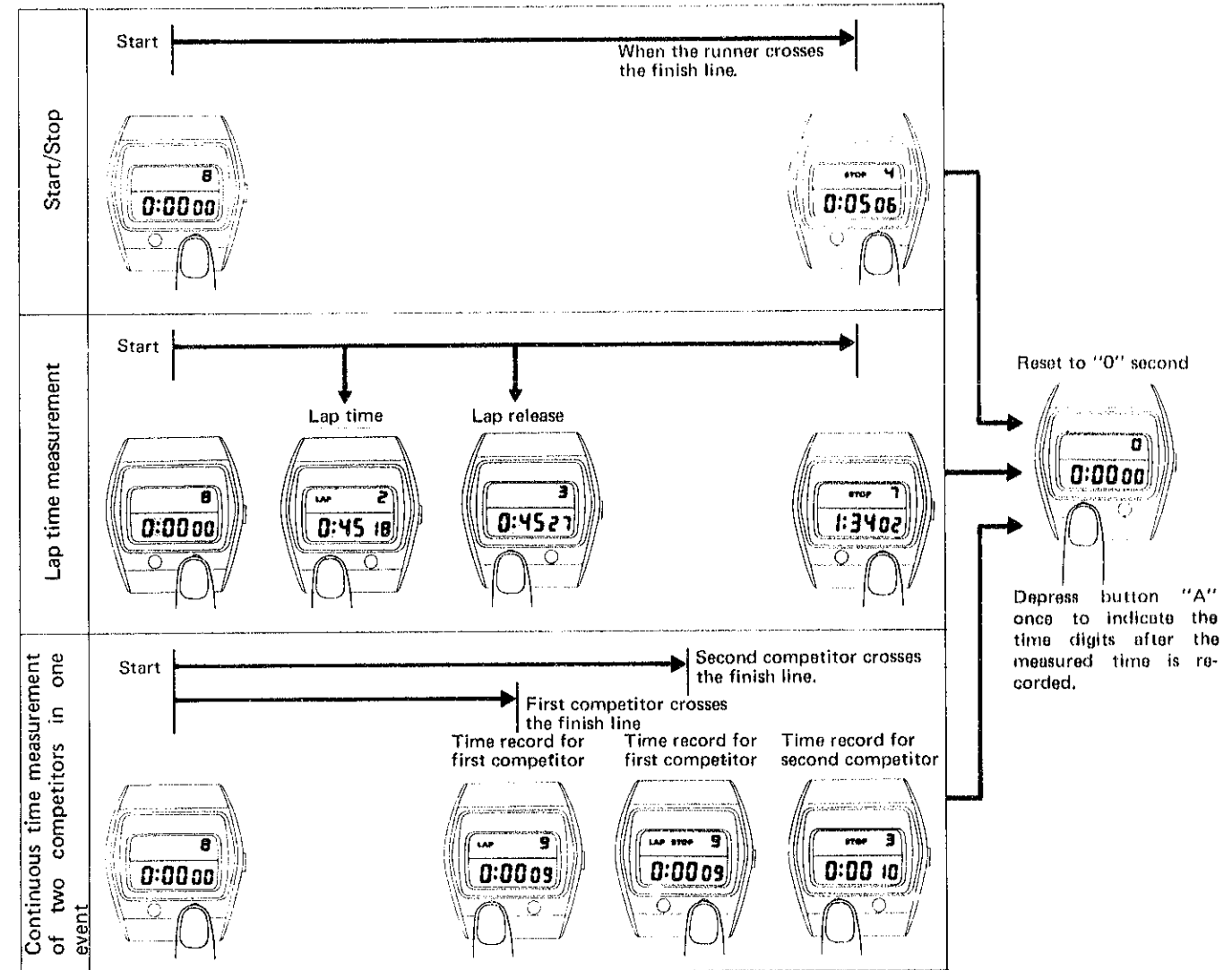

- The stopwatch device and the time and calendar device function independently. When the stopwatch device is used for a long continuous period, it is recommended that crown is depressed to indicate the time and calendar and should be depressed again when the time measurement is required. That prevents the button "A" or "B" from being depressed by mistake and upsetting the stopwatch measurement.

**5. Remarks for battery replacement**

Incomplete digital figures may be indicated on the display panel after battery is replaced. However, this is not a malfunction. Adjust the time and calendar digits.

[Example]



1. After-sale servicing instruments and materials

For after-sale servicing of SEIKO Quartz Digital Cal. M159A, the following instructions and materials are necessary.

(1) Quartz Tester QT-77

Used to check time accuracy (daily rate).

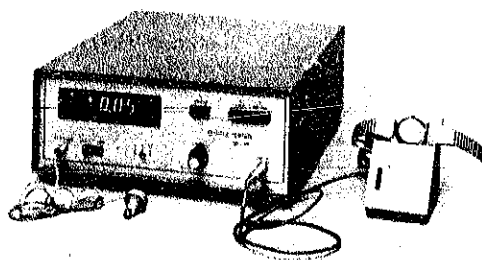

(4) Movement holder (S-644)

Used for disassembling and reassembling of the movement.

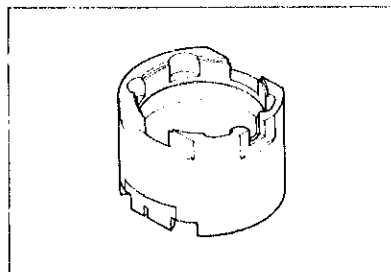

(2) Micro Test MT-10 II

Used to check current consumption and to supply voltage power constantly.

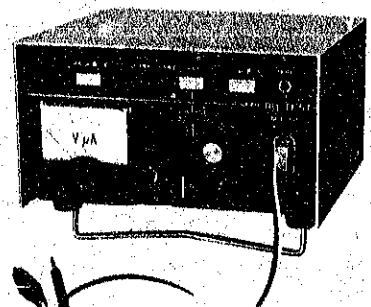

(5) Battery holding spring (S-815)

Used for securing battery and flowing current when the movement is removed from the case.

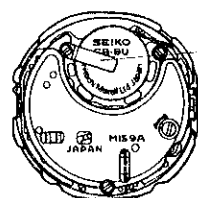
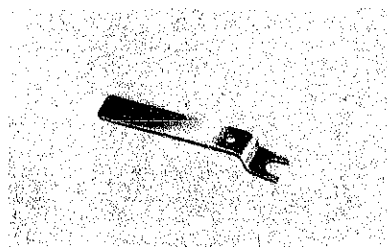

Battery holding spring

(3) Volt-ohm-meter

Used to check battery voltage and measure current consumption, etc.

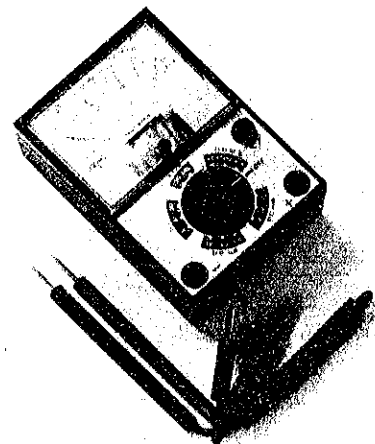

(6) Static electricity protector S-830

Used to protect the C-MOS-LSI of Digital Quartz from being damaged by static electricity.

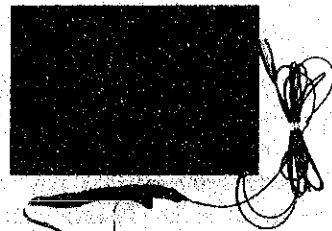

The reason of necessity:

When repairing the movement of the SEIKO Digital Quartz, be sure to use the Static Electricity Protector, S-830, in order to protect its circuit block from being damaged by static electricity.

The human body and clothes are often charged with static electricity of several thousands to several tens of thousands of volts, depending on environmental conditions. If this high voltage static electricity flows directly through the circuit block, the C-MOS-LSI will be damaged. The Static Electricity Protector, S-830, shunts the static electricity to ground, protecting the circuit block when it is repaired.

How to use

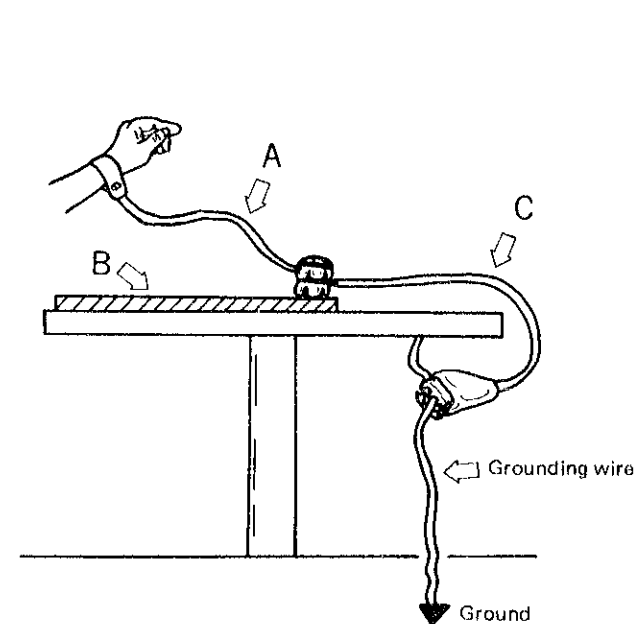

A

Wrist strap

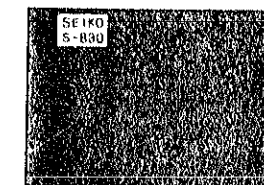

B

Conductive rubber sheet

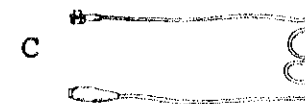

C

Earth connector

- Set up the Static Electricity Protector as illustrated above, and place the movement of the Digital Quartz Watch on the conductive rubber sheet (B) for repair. This rubber sheet is specially processed to have a conductivity for discharging static electricity.
- Put the wrist strap (A) direct around the naked skin, and not over clothing.
- Be sure to connect the earth connector (C) to the grounding wire directly connected to the ground, or connect the earth connector (C) to the grounding wire which is connected to the earth terminal at the outlet or a metallic water service pipe for the same effect.



## HOW TO USE QUARTZ TESTER QT-77

K. Hattori & Co., Ltd. has put on sale its new Quartz Tester QT-77. When measuring the watch accuracy by the new Quartz Tester QT-77, be sure to follow the instructions below.

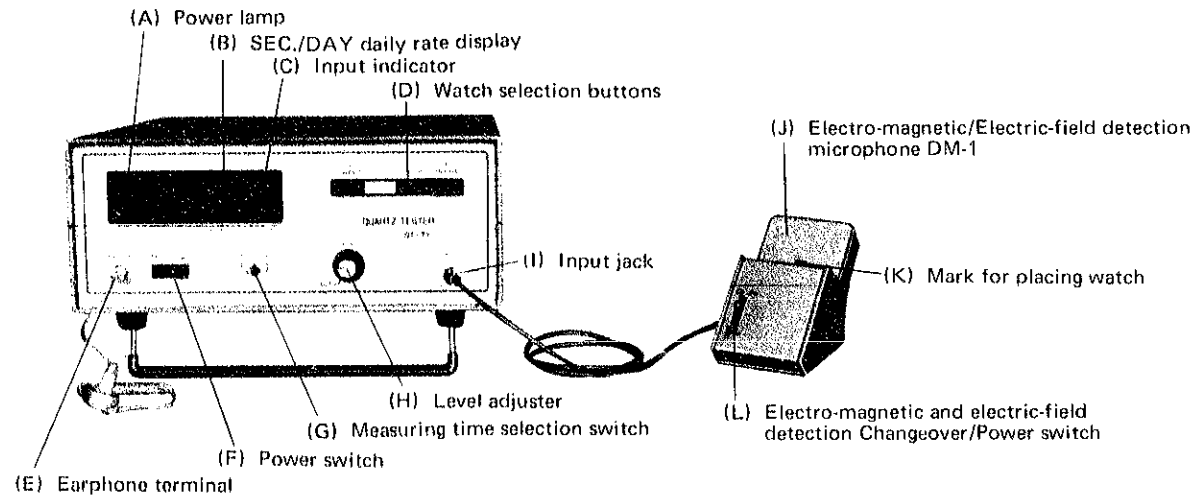

### Preparations before measurement

- Make sure that the voltage indicated by the supply voltage setting switch is the same as the voltage rating of your household power supply. If it isn't, turn the fuse holder counterclockwise (arrow-marked direction) and remove the fuse. Pull out the supply voltage setting switch and adjust it to the voltage rating of your power supply, and set the fuse in position.

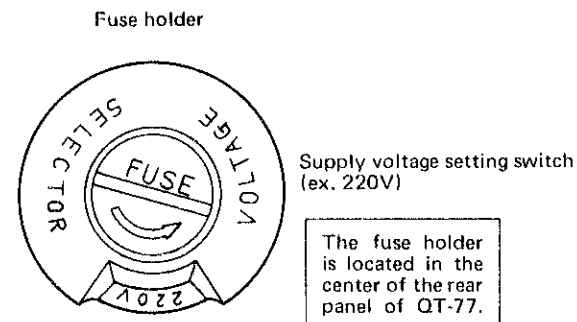

### Battery for Electro-magnetic/electric-field detection microphone DM-1

If the microphone is to be used for the first time, insert the battery (supplied along with the microphone) into the microphone. It is recommended to check the battery voltage periodically. When the microphone is not used turn the electro-magnetic and electric-field detection Changeover/Power switch to "STEP, SWEEP, LE" side, to preserve the battery life.

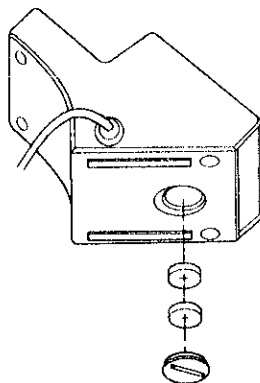

### Measurement of time accuracy (daily rate)

- (1) With the power switch (F) off, insert the power supply cord plug into the electric power outlet. Leave the Quartz Tester (QT-77) to stand for some 20 minutes.
- (2) Turn on the power switch (F). The power lamp (A) will light up.
- (3) Put the plug of the electro-magnetic/electric-field detection microphone DM-1 (J) all the way into the input jack (I).
- (4) Depress white button (LC) of the watch selection button.

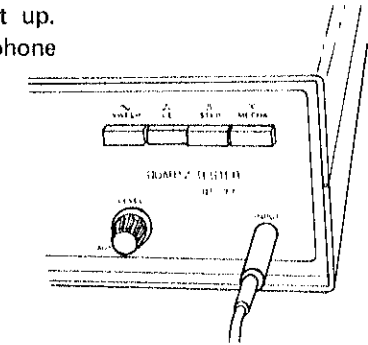

- (5) Set the measuring time selection switch (G) at "4 sec.", "6 sec." or "10 sec."

The daily rate can be measured at any position 4 sec., 6 sec. or 10 sec.

It is generally accepted, however, that the longer the measuring time is the more accurate will be the measurement.

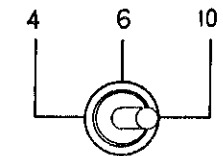

- (6) Insert the earphone cord plug into earphone terminal (E).
- (7) Turn the level adjuster (H) to AUTO position (turn it counterclockwise until a click is heard).
- (8) Push the switch (L) of the microphone (J) to the LC-ON position (electric-field detection function).
- (9) Place the watch on the microphone.

Place the watch with its liquid crystal display facing the mark  (K) in the center of the microphone.

Put on the earphone, and move the watch on the microphone in various ways, and by changing its position and angle, the volume will change. Determine the watch position and direction where the earphone sound becomes loudest. At this time, the input indicator (C) will remain lit.

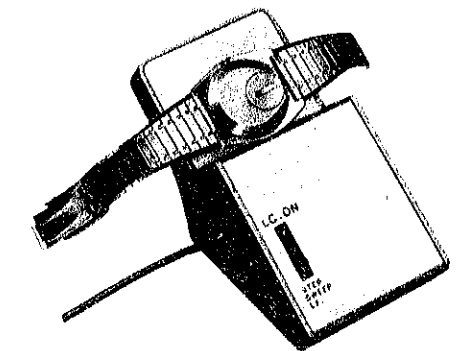

#### Note:

In almost all cases, all the above procedures will be sufficient for measuring the daily rate. If the input indicator flashes or does not light up at all, turn the level adjuster to keep the input indicator lit during measurement.

- (10) Read the daily rate on the display panel (B). If the daily rate of the watch exceeds the measurable range, it is not displayed on the panel.

#### Note:

If the glass of the watch has perspiration or oil on it, the Quartz Tester QT-77 does not pick up the signal.

Be sure not to put the watch in a vinyl bag while it is being measured.

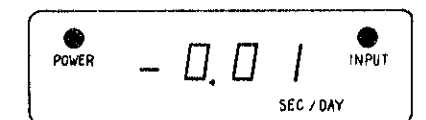

## 2. Disassembling and reassembling of the case

Lubricating : Silicone grease (500,000 c.s.)  
Normal quantity  
(lubricate gaskets)

### < Disassembling procedures >

### < Reassembling procedures >

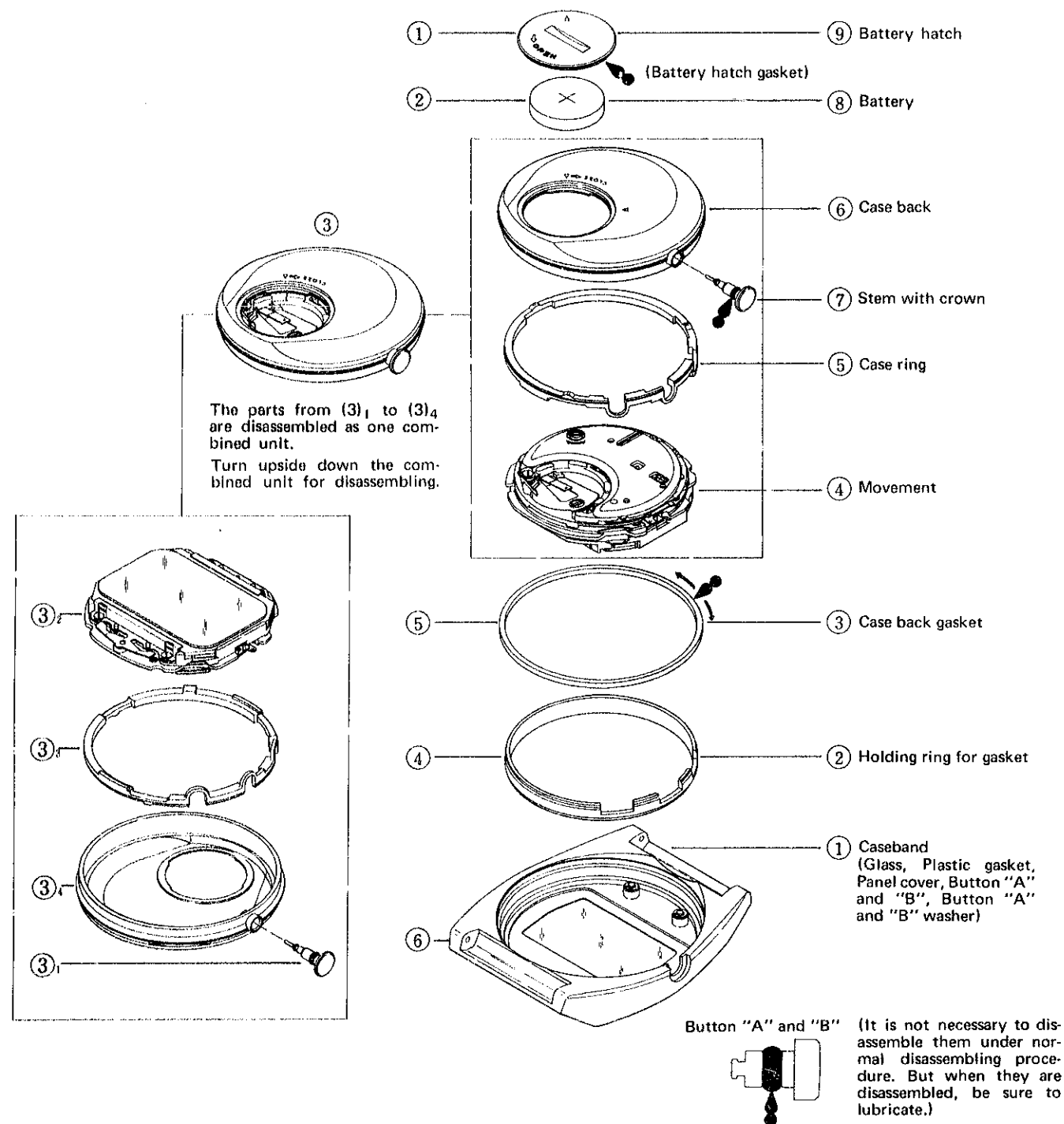

### REMARKS FOR DISASSEMBLING

(3) The case back can be disassembled by pushing the case opener into the opening notch. (The parts from (3)<sub>1</sub> to (3)<sub>4</sub> are disassembled as one combined unit.)

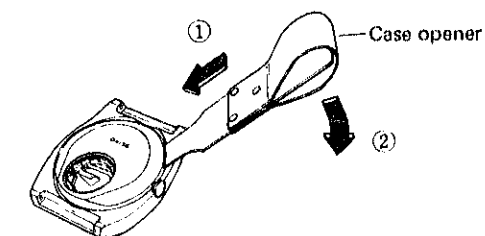

(3)<sub>1</sub> Stem with crown  
While pushing the arrow-marked portion with tweezers, pull out the stem with crown.

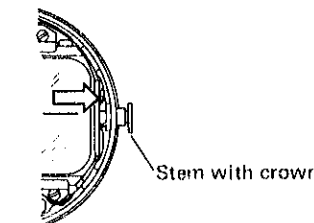

### REMARKS FOR REASSEMBLING

(2) Holding ring for gasket  
(4) Movement  
(5) Case ring

Reassemble the above three parts as shown in the illustration on the right. Make sure that they are reassembled in the correct position and direction.

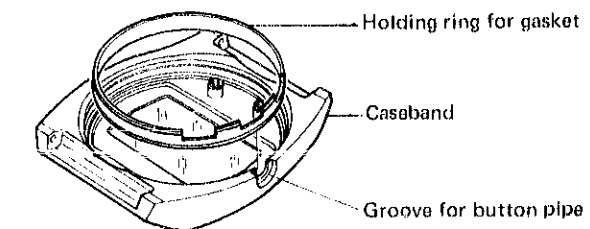

(6) Case back  
i) Mount the case back evenly on the caseband making sure that the stem with crown is set into the groove.  
ii) Push the case back hard with fingers so that the caseband is snapped closed to the case back firmly as shown in the illustration. If it is not snapped closed with fingers, use SEIKO tightening tool.

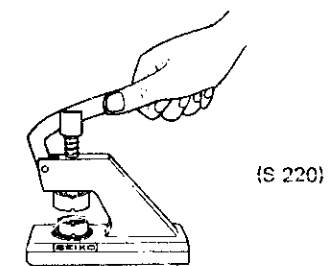
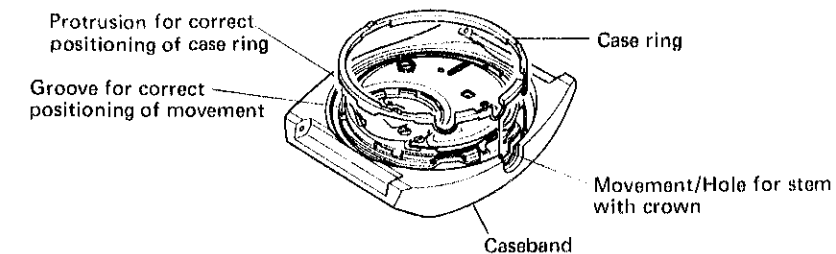

(7) Stem with crown  
After reassembling, check to see if the stem with crown is pulled out and then pressed in correctly.

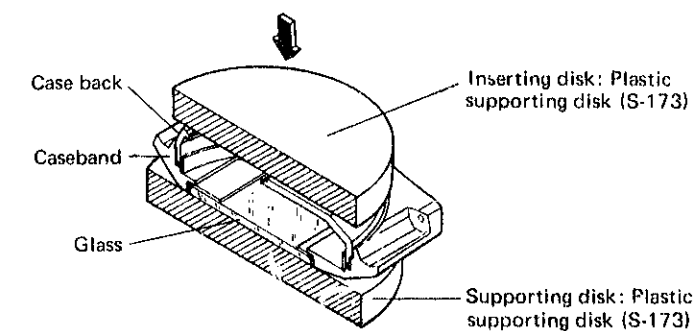

## REPLACEMENT OF THE GLASS

(As the glass is combined with the caseband, disassemble it only when the replacement of parts is necessary. Use the case tightening tool S-220.)

### ● How to disassemble the glass

Use the S-160 Disk unit to disassemble the glass.

Inserting disk:  $\phi 18.5 \text{ mm} \sim \phi 19.5 \text{ mm}$   
Supporting disk:  $\phi 33.0 \text{ mm} \sim \phi 35.0 \text{ mm}$

- Place a vinyl sheet between the supporting disk and the glass as shown in the illustration.
- Push the glass together with the panel cover for disassembling.

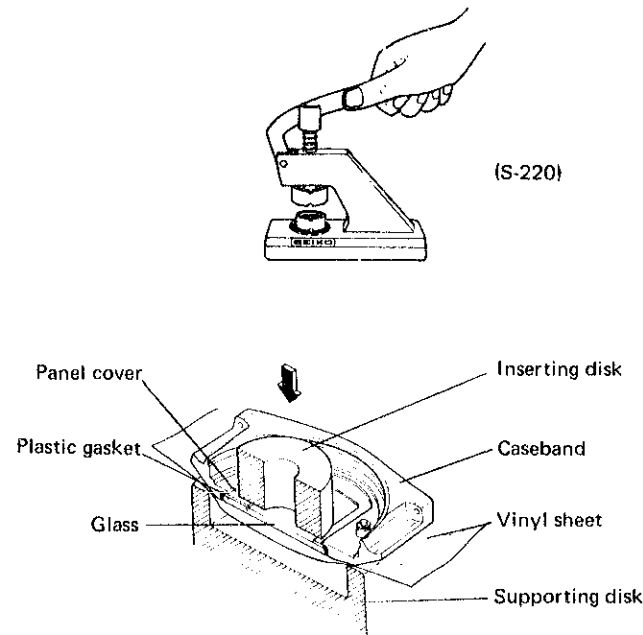

### ● How to reassemble the glass

#### i) Fix the plastic gasket

- Be sure to replace it with a new plastic gasket so as to maintain high water-resistance.
- Do not mistake the upper side of the gasket for the lower side.

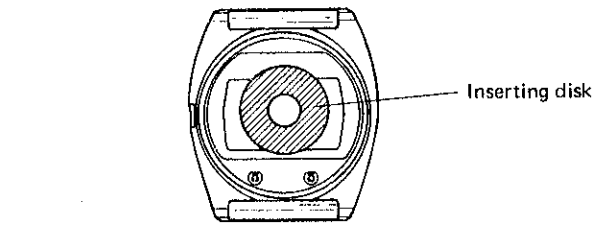

#### ii) Fix the panel cover

Be sure to fix the back side of the panel cover firmly to the caseband.

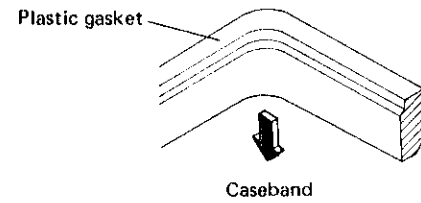

#### iii) Set the glass

Do not mistake the upper side (narrow bevel) of the glass for the lower side (wide bevel) which fits into the caseband.

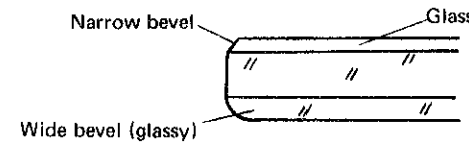

#### iv) Push the glass in

Inserting disk: Plastic supporting disk (S-173)  
Supporting disk:  $\phi 26.0 \text{ mm} \sim \phi 27.0 \text{ mm}$

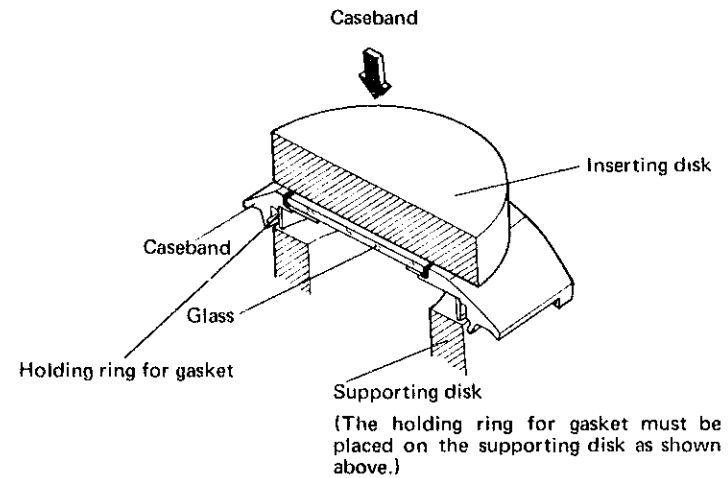

## 3. Disassembling and reassembling of the movement and lubricating of the switch components

Disassembling procedures Figs.: ① ~ ⑳

Reassembling procedures Figs.: ⑳ ~ ①

Lubricating: SEIKO Watch Oil, S-6, Normal quantity

ALL THE SCREWS USED ARE THE SAME.

### NOTE:

After reassembling, hold the battery with the battery holding spring and check the display. If there are any display failures, the connector might not be placed in the correct position. Move the connectors and reassemble them in the correct position.

### Reflecting mirror

Note for disassembling and reassembling

- Be careful not to scratch the surface
- Reassemble with the black coated side down.

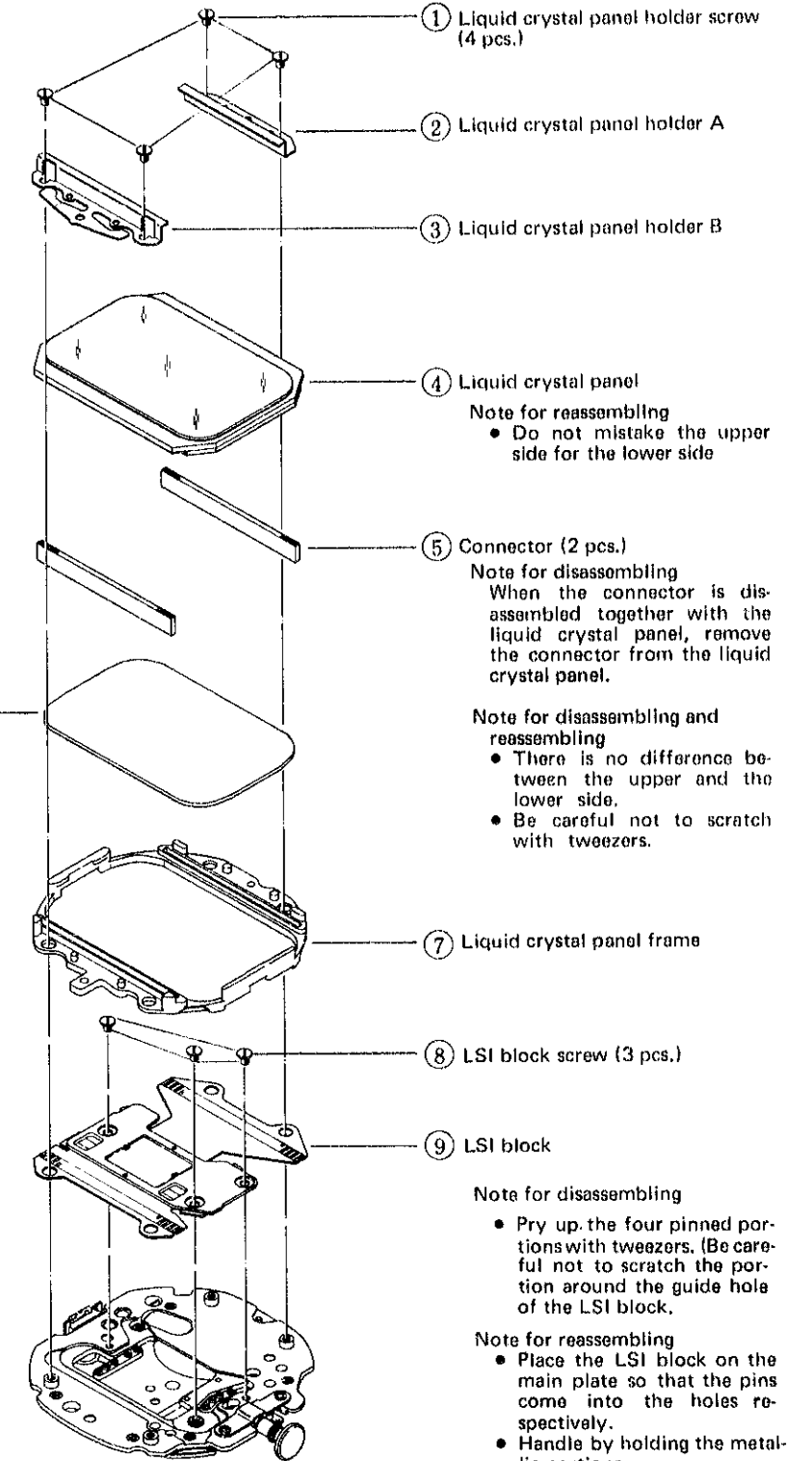

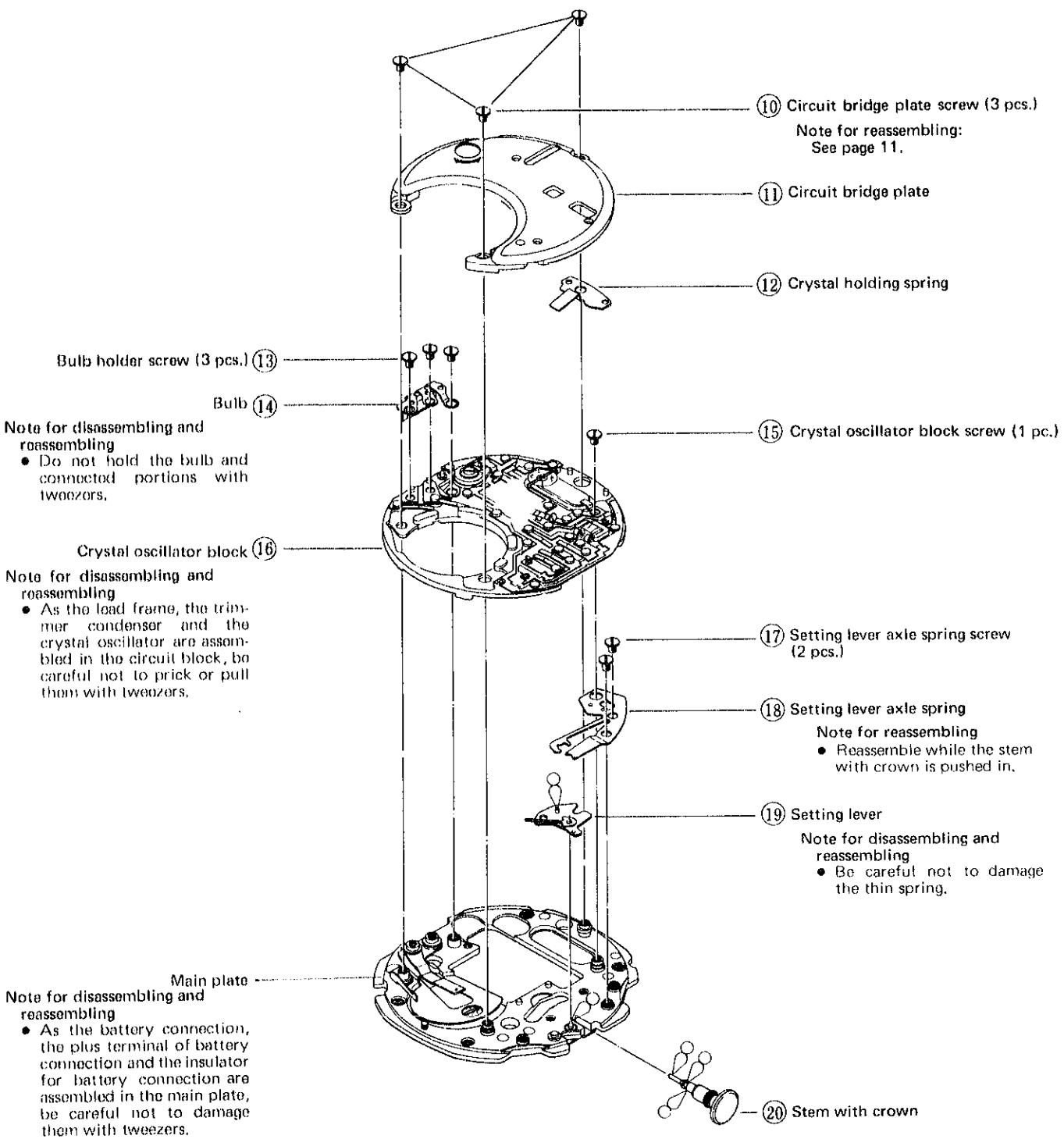

### REMARKS FOR REASSEMBLING

With the movement reassembled by following the procedures from ⑳ to the circuit bridge plate screw ⑩ as explained in Page 14, check the movement by the following procedures.

1. When the stem with crown is in the normal position, the spring of the setting lever touches neither pin (A) nor pin (B).

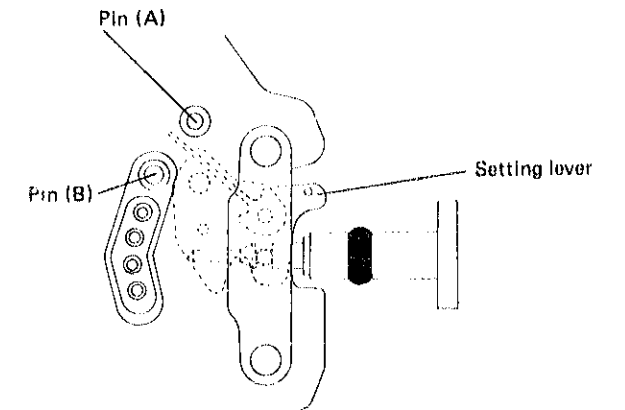

2. When the stem with crown is pushed in, the spring of the setting lever touches pin (A) but it does not touch pin (A) when the stem with crown is released back to the normal position.

This acts as a switch mechanism and enables the watch to change from the time and calendar function to the stopwatch function and vice versa.

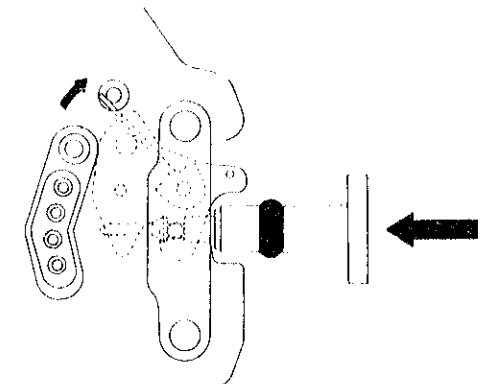



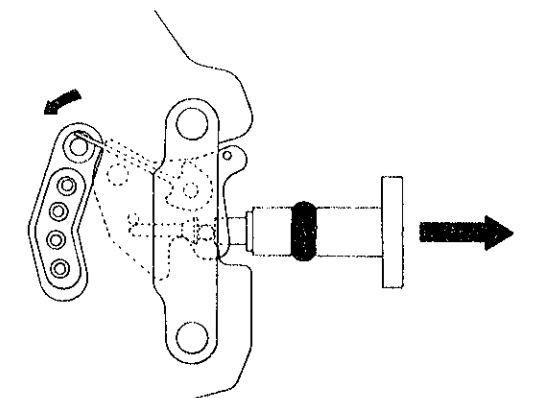

3. When the stem with crown is pulled out, the spring of the setting lever touches pin (B), and this makes the time and calendar display ready to be adjusted.

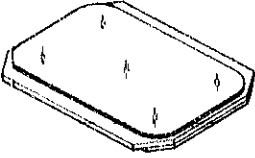

#### 4. Cleaning

Since several parts of M159 differ from conventional mechanical watches, use the following method when cleaning.

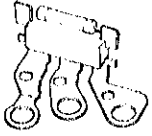
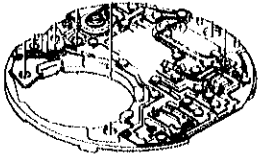
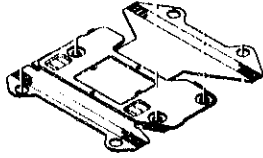
##### HOW TO CLEAN

Name of parts	Cleaning	Drying	Solution	Remarks
Liquid crystal panel 	DO NOT CLEAN			<ul style="list-style-type: none"> <li>Wipe dust and lint off with a soft brush.</li> <li>Wipe the electrodes of the liquid crystal panel and the LSI block ONLY with a cloth moistened with benzine or alcohol.</li> </ul>
Reflecting mirror 				
Bulb 				
Crystal oscillator block 				
LSI block 				
Connector 				
Main plate Liquid crystal panel frame Circuit bridge plate	Rinse or wash with a soft brush	Cool air	Benzine or alcohol	
Parts other than above	Clean with cleaner, rinse or wash with a soft brush.	Cool or hot air	Trichloroethylene, benzine or alcohol	

#### IV. CHECKING AND ADJUSTMENT

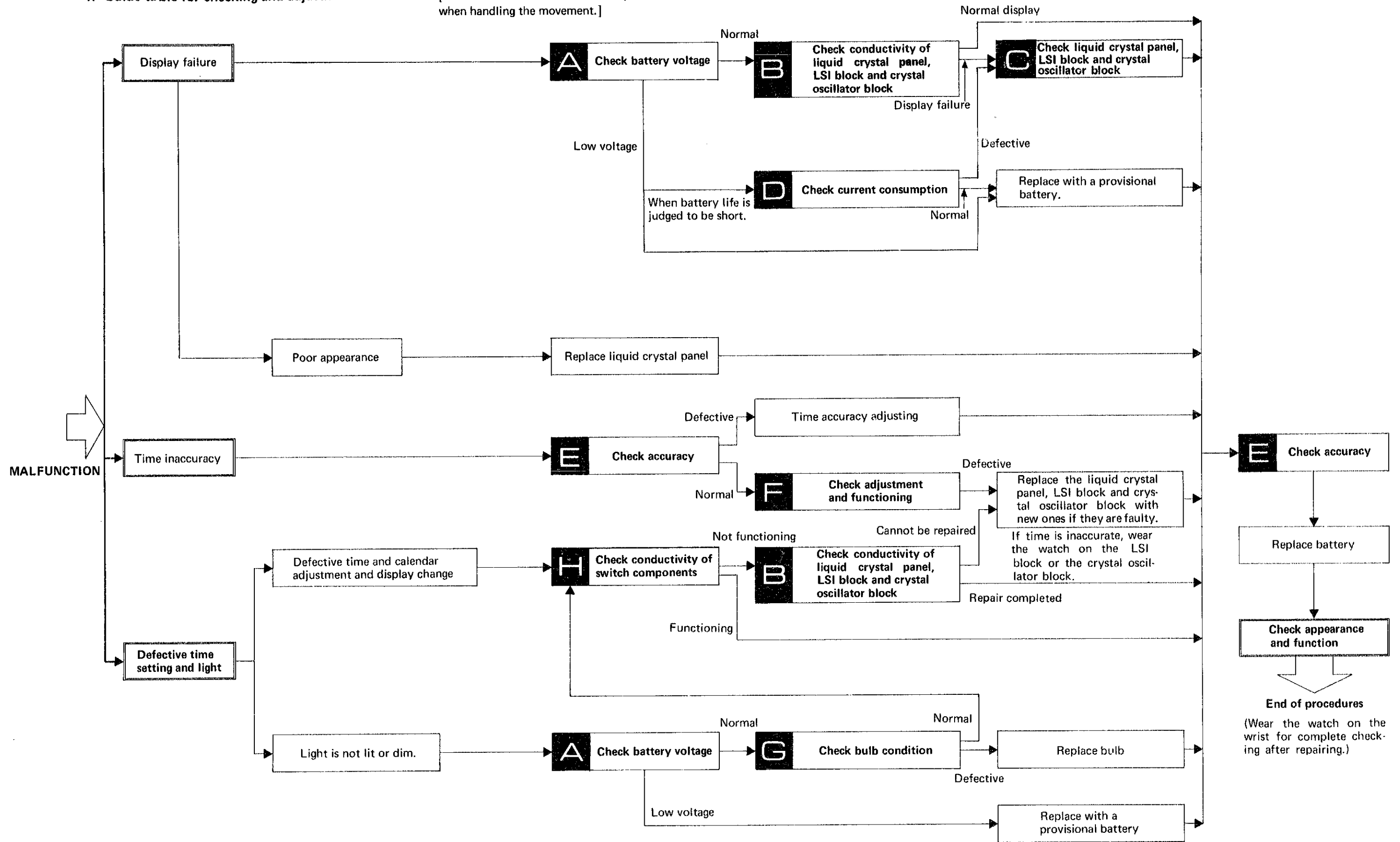

##### 1. Guide table for checking and adjustment

[Be sure to use the Static Electricity Protector S-830 when handling the movement.]



## 2. Malfunction and checking points

- Check in the numerical order.
- Refer to "Guide table for checking and adjustment" on page 17.

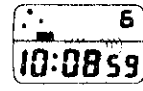
FAULTY SYMPTOMS		CHECKING POINTS							
		A	B	C			F	G	H
		Battery voltage	Conductivity of liquid crystal panel, LSI block and crystal oscillator block	Liquid crystal panel	LSI block Crystal oscillator block	Time accuracy adjusting	Adjustment and functioning	Bulb	Switch components
DISPLAY FAILURE	No digital display, all segments are dim or poor response.	①	②	③	④				
	Some segments of the digital figures are not lighted. 		①	②	③				
	All segments are displayed or the segment which should be on and off is reversed as shown in the illustration. 								
(Deflection) Some or all of one segment show different contrast depending on the direction of view. 	(Poor appearance) Some portions of the liquid crystal panel will have air bubbles or iridescent view. Example: 			①					
TIME INACCURACY	Gain or loss tested by Quartz Tester.					①			
	Though Quartz tester indicates the normal figures, a watch gains or loses when it is worn on the wrist.		②		③		①		
DEFECTIVE TIME AND CALENDAR SETTING, DISPLAY CHANGEOVER OR LIGHT	Defective time and calendar setting or failure of changeover of time and calendar display		②		③				①
	Light is not lit or light is lit but dims soon.	①	④		⑤			②	③

### 3. Relation between segment (Liquid Crystal Panel Electrode) and C-MOS-LSI output terminal

A complete knowledge of how the segment (Liquid Crystal Panel Electrode) works with the C-MOS-LSI output terminal will provide the correct procedures for checking and adjustment.

**Note:** All segments are displayed or the segment which should be on and off is reversed when the common electrode causes defective conductivity.

- Designation of segment

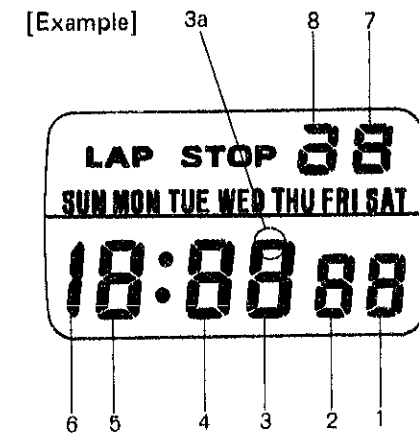

- Connection with segment and C-MOS-LSI output terminal

The liquid crystal panel electrode is connected electrically with each segment which forms a digital figure as shown in the illustration of the panel pattern below.

(The panel pattern can be seen if the panel is slightly tilted and looked at in an angular position.)

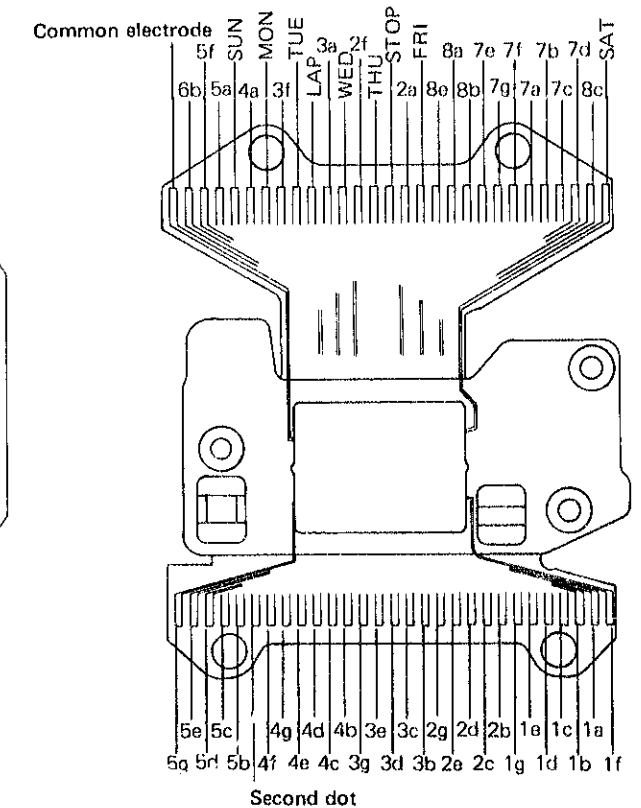
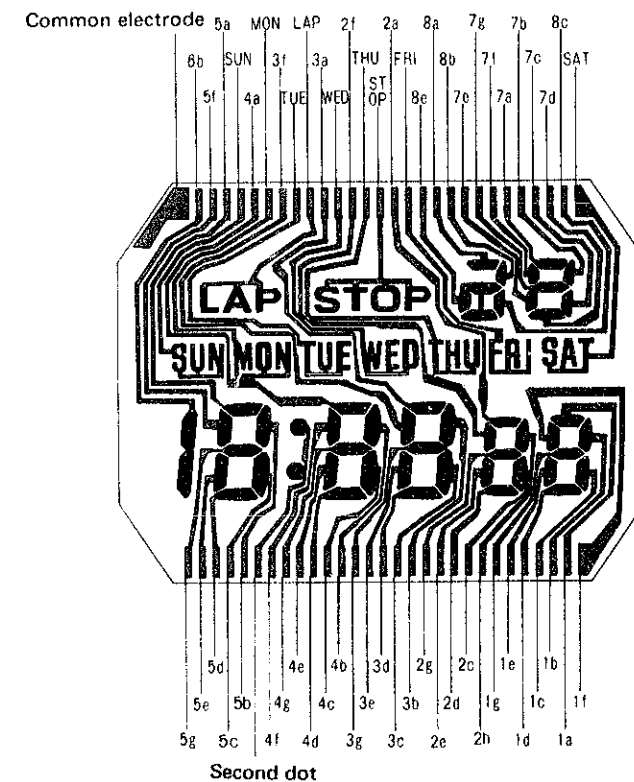

Also, the liquid crystal panel electrode is connected electrically with the C-MOS-LSI output terminal by the connector.



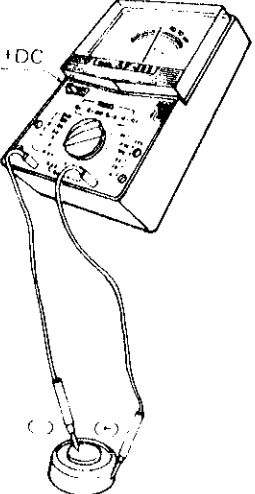
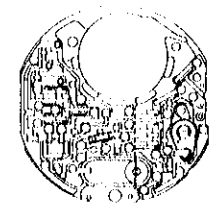
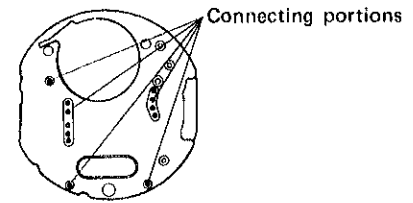
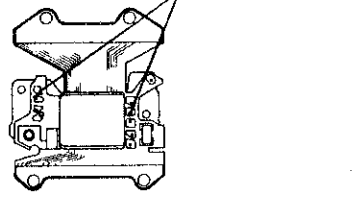

4. Procedures for checking and adjustment

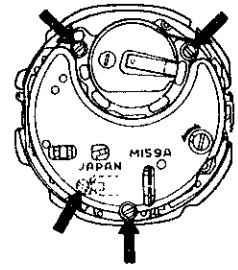
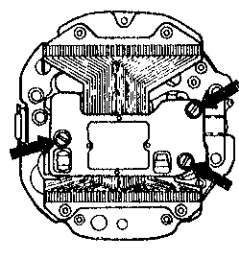
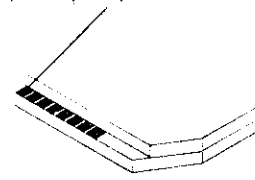
CHECK BATTERY VOLTAGE	Procedure	Result and Repair
A	<p>Use the following procedures to check battery voltage.</p> <p>1. Set up the volt-ohm-meter Range to be used: DC 3V</p> <p>2. Measuring</p> <ul style="list-style-type: none"> <li>Probe Red (+) . . . . Battery surface (+)</li> <li>Probe Black (-) . . . . Battery surface (-)</li> </ul> <p>When there is battery electrolyte leakage, refer to "HOW TO CHECK BATTERY ELECTROLYTE LEAKAGE AND REPAIR" below for repairing.</p>	 <p>More than 1.5V . . . . Normal Less than 1.5V . . . . Defective</p>
HOW TO CHECK BATTERY ELECTROLYTE LEAKAGE AND REPAIR	<p>1. Remove the movement from the case</p> <p>2. Disassemble the movement</p> <p>3. Wipe off battery electrolyte on the crystal oscillator block and the LSI block</p> <p>(1) Wipe off battery electrolyte on the lead frame, each connecting portion, etc. with a cloth moistened with distilled water. (Do not use such fluffy cloth as gauze, flannel, etc.) When the crystal oscillator block and the LSI block are cleaned, be sure to clean the shaded portions shown below and the connecting portions.</p> <p><b>Note:</b> Do not expose the trimmer condenser to water or alcohol, and if it is exposed, there may be a change in its condenser capacity and eventually in the time accuracy.</p> <div style="display: flex; justify-content: space-around;"> <div data-bbox="192 1081 400 1344"> <p>Crystal oscillator block</p>  <p>Case back side</p> </div> <div data-bbox="563 1081 949 1344"> <p>Connecting portions</p>  <p>Display panel side</p> </div> <div data-bbox="964 1081 1305 1344"> <p>LSI block</p>  <p>Main plate side</p> </div> </div> <p>(2) Wipe the shaded portions and the connecting portions again with a cloth moistened with alcohol. (If the cleaned portions remain wet with water, they will corrode with rust.)</p> <p>(3) Dry with cool air by using a dryer.</p> <p>4. Wipe off battery electrolyte on the other parts (main plate, switch components, etc.).</p> <p>(1) Wipe off battery electrolyte on each portion with a soft brush moistened with distilled water. (If distilled water is not available, use ordinary water.)</p> <p>(2) Rinse with alcohol.</p> <p>(3) Dry with cool air by using a dryer.</p> <p>5. Reassemble the movement Replace the battery with a new one.</p> <p>6. Check if the time setting functions and the current consumption are normal.</p>	

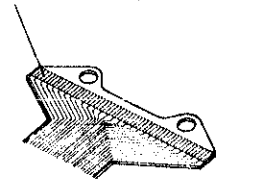
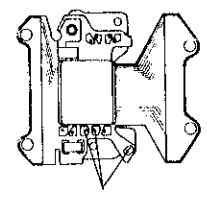
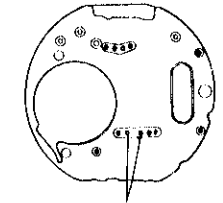
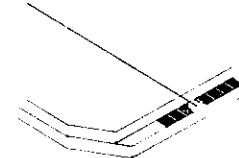
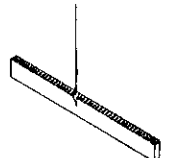
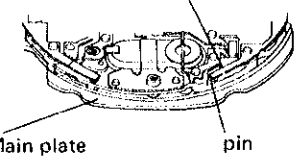
CHECK CONDUCTIVITY OF LIQUID CRYSTAL PANEL, LSI BLOCK AND CRYSTAL OSCILLATOR BLOCK	Procedure	Result and Repair
B	<p>(1) Make sure that the screws are tightened firmly.</p> <p>1. Crystal oscillator block screw (1 pc.), circuit bridge plate screws (3 pcs.) 2. LSI block screws (3 pcs.)</p> <div style="display: flex; justify-content: space-around;">   </div> <p>(2) Check for dust, lint or other contamination on the conductive portions shown in the illustration below.</p> <div style="display: flex; justify-content: space-around;"> <div data-bbox="1736 735 2003 934"> <p>Liquid crystal panel electrode</p>  </div> <div data-bbox="2047 735 2166 934"> <p>Connector</p>  </div> <div data-bbox="2211 735 2463 934"> <p>LSI block output terminal</p>  </div> </div> <div style="display: flex; justify-content: space-around;"> <div data-bbox="1795 997 1988 1291"> <p>LSI block</p>  <p>Connecting portions with the crystal oscillator block and the pins. (10 portions)</p> </div> <div data-bbox="2151 997 2359 1291"> <p>Crystal oscillator block</p>  <p>Check for dust, lint or other contamination on the pin heads.</p> </div> </div> <p>(3) Check the liquid crystal panel electrode for any glass defect and the connector for any tiny break.</p> <div style="display: flex; justify-content: space-around;"> <div data-bbox="1795 1470 2018 1648"> <p>Glass defect</p>  </div> <div data-bbox="2151 1470 2329 1648"> <p>Tiny break or crack</p>  </div> </div> <p>(4) Remove the circuit bridge plate and check the connection of the lead frame of the crystal oscillator block with the pins by using a microphone.</p> <div style="display: flex; justify-content: space-around;">  </div>	<p>No loosened screws . . . Normal Proceed to <b>B</b><sub>2</sub></p> <p>Loosened screws . . . . Defective Retighten screws</p> <p>Uncontaminated . . . Normal Proceed to <b>B</b><sub>3</sub></p> <p>Contaminated . . . . Defective Wipe off any foreign matter.</p> <p>No glass defects, break or crack . . . . . Normal Proceed to <b>B</b><sub>4</sub></p> <p>Glass defects, break or crack . . . . . Defective Replace with new ones</p> <p>Lead frame . . . . . Normal If time is inaccurate, wear the watch on the wrist for test.</p> <p>. . . . . Defective Bend the lead frame with tweezers so that it touches the pin.</p>

**Procedure**

Check to see if the liquid crystal panel and the crystal oscillator block function correctly. (Refer to "Relations between the segment and the C-MOS-LSI output terminal" on page 19.)

**1. Check liquid crystal panel**

(1) Set up the volt-ohm-meter

Range to be used: OHMS R X 1 ~ R X 1K

**Note:**

- Any range will do if more than 3V is applied to the terminal of the volt-ohm-meter.
- If the output voltage of the volt-ohm-meter is less than 3V in measuring, all segments may not be lit. When no segment is lit, change the range to R X 10K which is higher in resistance than R X 1K.

(2) Remove the liquid crystal panel from the movement and turn it upside down. Apply the probes.

(3) Measuring

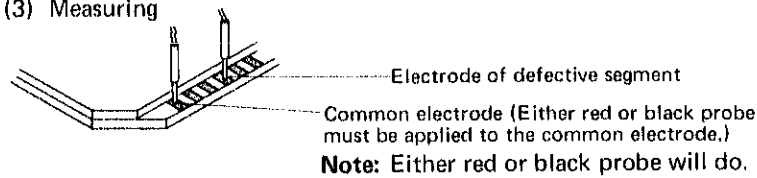

**2. Check the LSI block and crystal oscillator block output voltage.**

(1) Set up the volt-ohm-meter.

Range to be used: DC 3 V

(2) After reassembling the battery and the battery holding spring to the movement, remove the liquid crystal panel holder screw, liquid crystal panel holder, liquid crystal panel, connector, reflecting mirror and the panel frame ⑦ as explained on page 13.

(3) Measuring

Probe Red (+) . . . Main plate  
 Probe Black (-) . . . One of the output terminals of the C-MOS-LSI

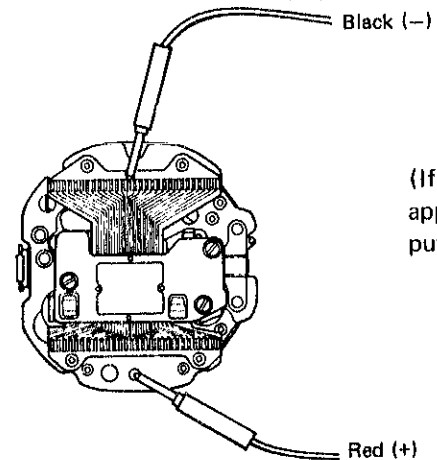

(If some displays are defective, apply to the corresponding output terminals of the C-MOS-LSI.)

**Result and Repair**

Lights up . . . . . Normal  
 Proceed to **C** 2

Does not light up . . . Defective  
 Replace the liquid crystal panel with a new one.

More than 0.8 V . . . Normal  
 (All the terminals must be more than 0.8 V.)  
 Return to **B**

Less than 0.8 V . . . Defective

→ Replace the crystal oscillator block or the LSI block with a new one and check to see if it functions correctly. (This will tell which block is defective.)

**Procedure**

Check to see if the current consumption is normal.

Check under the following three conditions.

1. Time and calendar function
2. Stopwatch function
3. Time and calendar adjusting function

**Measuring**

**(1) Micro Test**

- Probe Red (+) . . . . Case
- Probe Black (-) . . . . Battery connection

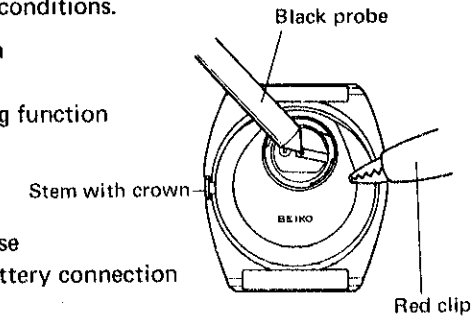

If current consumption cannot be measured (if electricity does not flow from the movement to the case), apply the red probe (+) to button "B" (or stem with crown) for measuring.

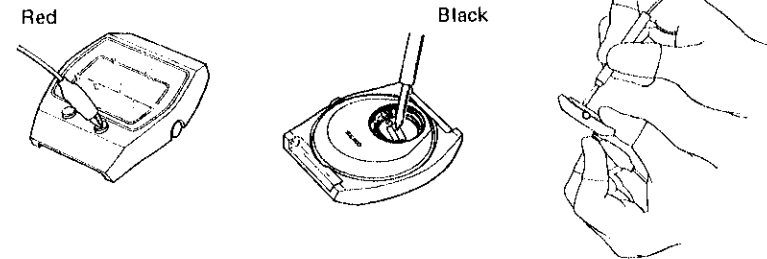

**Reason:**

- Button is connected electrically with (+).
- Application of a probe to button "A" activates the light and electricity consumption increases excessively.

**(2) Volt-ohm-meter**

Place the battery on the case back with its minus surface turned up.

Range to be used: DC 0.03 mA\*

- Probe Red (+) . . . . Battery connection
- Probe Black (-) . . . . Battery surface (-)

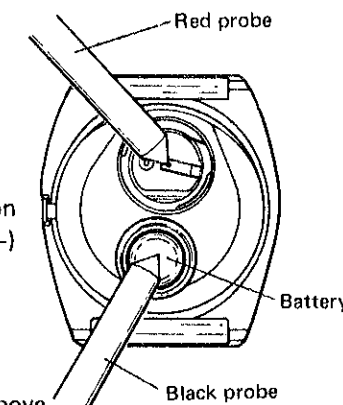

If measurement is impossible by the above procedures, place the battery on button "B" (or stem with crown) and touch it with the probe.

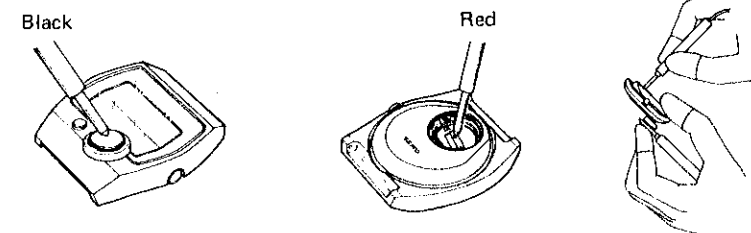

**Result and Repair**

**\* Note:**  
 If the pointer of the volt-ohm-meter swings over the maximum value when DC 0.03mA is used, change the range to a greater one where the pointer does not run over the maximum value while applying the probes to the respective portions. Then, after two or three seconds, return the range to DC 0.03mA again for measuring.

Less than 3.5  $\mu$ A . . . Normal  
 Replace with a provisional battery

More than 3.5  $\mu$ A . . . Defective  
 Proceed to **C**

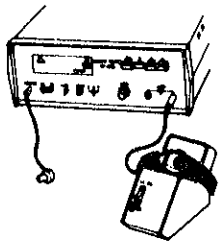
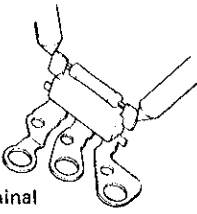
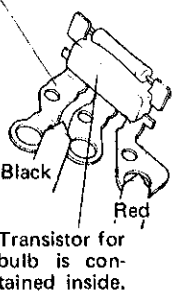
	Procedure	Result and Repair
CHECK ACCURACY	<p>Check gain and loss of time.</p> <p><b>1. Set up the Quartz Tester.</b></p> <p>As there are several different types of the Quartz Testers, refer to the respective instruction manual.</p> <p><b>2. Measuring</b></p> 	<p>Neither gain nor loss ... Normal            Either gain or loss ..... Defective            Time accuracy adjusting (See page 26 for reference.)</p>
CHECK ADJUSTMENT AND FUNCTIONING	<p><b>1. Check adjustment</b></p> <p>Check to see if the digit adjustment can be made correctly by the button operation following the procedures on page 4.</p> <ul style="list-style-type: none"> <li>Check adjustment by following all the adjusting procedures.</li> </ul> <p><b>2. Check functioning</b></p> <p>Check to see if the stopwatch device functions correctly by following the procedures on page 5.</p>	<p>Can be adjusted . . . . . Normal            Proceed to <b>B</b></p> <p>Cannot be adjusted . . . Defective</p> <p>Replace the LSI block or crystal oscillator block with new ones.</p>
CHECK BULB CONDITION	<p>Check to see if the bulb functions correctly.</p> <p><b>1. Check to see if there are any loosened bulb holder screws (3 pcs.)</b></p> <p><b>2. Check by the Volt-ohm-meter.</b></p> <p>(1) Remove the bulb from the crystal oscillator block.</p> <p>(2) Set up the Volt-ohm-meter            Range to be used: OHMS R X 1</p> <p>(3) Checking</p> <p>I) Check to see if there is a broken filament in the bulb and if there is any break in the soldered portion of the terminal.</p> <p>Probe Red (+) Apply to either side of the bulb            Probe Black (-)</p>  <p>II) Check to see if the transistor for bulb functions correctly.</p> <p>Probe Red . . . Bulb lead terminal shown in the illustration.            Probe Black . . . Two other bulb lead terminals.</p> <p>Note: The light might become slightly dim due to the transistor used for the bulb.</p> 	<p>No loosened screw . . . Normal            Proceed to <b>G</b> 2</p> <p>Loosened screws . . . Defective            Retighten screws</p> <p>Lights up . . . . . Normal            Proceed to <b>G</b> (3) II)</p> <p>Does not light up . . . Defective            Replace bulb with a new one.</p> <p>Lights up . . . . . Normal            Proceed to <b>H</b></p> <p>Does not light up . . . Defective            Replace bulb with a new one.</p>

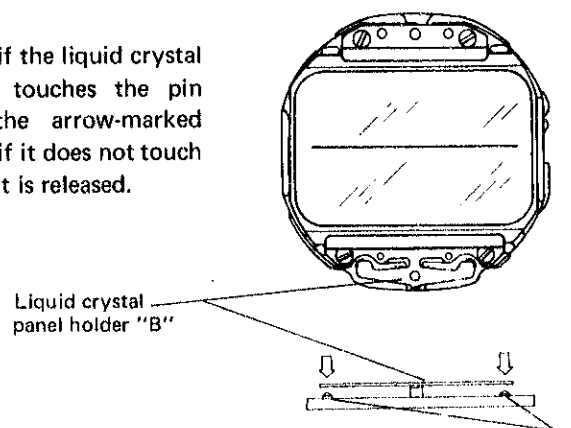
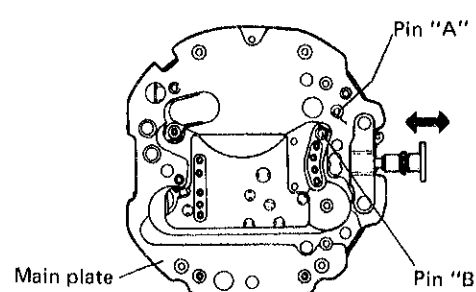
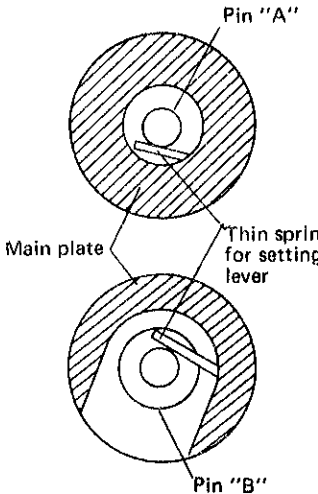
	Procedure	Result and Repair
CHECK CONDUCTIVITY OF SWITCH COMPONENTS	<p><b>1. Remove the movement and check to see if the switch portion of the liquid crystal panel holder "B" functions correctly.</b></p> <ul style="list-style-type: none"> <li><b>Checking</b>            Check to see if the liquid crystal panel holder touches the pin pushed in the arrow-marked direction and if it does not touch the pin when it is released.</li> </ul>  <p><b>2. Check to see if the thin spring of the setting lever functions correctly.</b></p> <p>Check after disassembling procedures have been completed up to (9) LSI block and setting the stem with crown in position as explained on page 13.            (Pins "A" and "B" are combined with the crystal oscillator block.)</p>  <ul style="list-style-type: none"> <li><b>Checking</b>            Check with a microscope.           <ol style="list-style-type: none"> <li>Check to see if the thin spring of the setting lever touches the pin "A" when the stem with crown is pushed in and if it disconnects from pin "A" when the stem with crown is released.</li> <li>Check to see if the thin spring of the setting lever touches the pin "B" when the stem with button is pulled out and if it does not touch the pin "B" when the stem with button is pushed in.</li> </ol> </li> </ul>  <p>(3) Check for dust, lint or other contamination on the conductive portions of the parts above.</p> <div style="border: 1px solid black; padding: 5px; margin-top: 10px;"> <p>When there is battery electrolyte leakage, refer to "HOW TO CHECK BATTERY ELECTROLYTE LEAKAGE AND REPAIR" for repairing.</p> </div>	<p>Functions correctly . . . Normal            Proceed to <b>H</b> (2)</p> <p>Does not function correctly . . . . . Defective            Adjust the switch</p> <p>(If adjustment is impossible, replace the liquid crystal panel holder "B" with a new one.)</p> <p>Functions correctly . . . . . Normal            Proceed to <b>H</b> (3)</p> <p>Does not function correctly . . . . . Defective            Adjust the thin spring.</p> <p>(If adjustment is impossible, replace the setting lever with a new one.)</p> <p>Untamminated . . . Normal            Proceed to <b>B</b></p> <p>Contaminated . . . . . Defective            Wipe off carefully</p>

## TIME ACCURACY ADJUSTING

Time accuracy of Cal. M159A is adjusted by turning the trimmer condenser.

- **Adjusting method**

The watch will gain or lose according to the direction in which the trimmer condenser is turned. Adjustment should therefore be made after ascertaining with the Quartz Tester whether the watch tends to gain or lose.

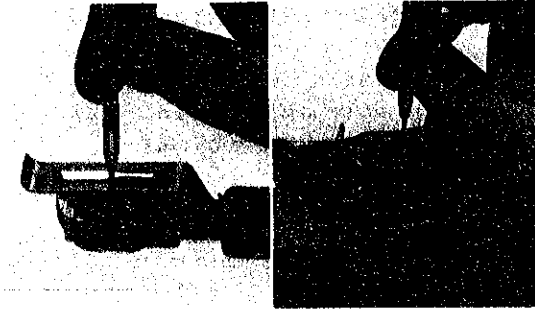

- **Note for handling the trimmer condenser**

Avoid excessive depressing and turning of the trimmer condenser.

- **Function of the Trimmer Condenser**

The trimmer condenser consists of a rotor electrode and a stator electrode as shown in the diagram. Turning the shaft fixed to the rotor changes the overlapped area between the stator electrode and rotor electrode, which in turn changes the capacity of the trimmer condenser.

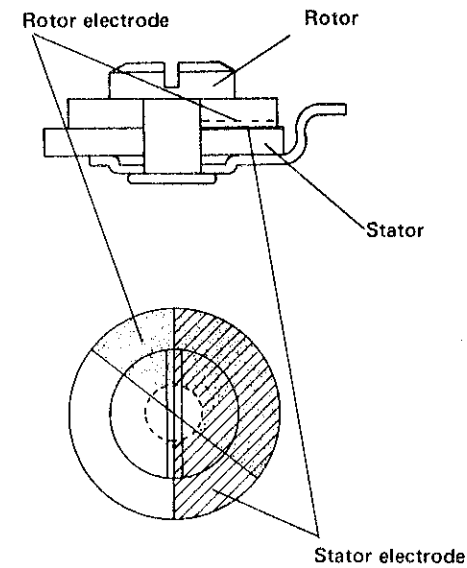

- **Change in the capacity of trimmer condenser and the adjusting accuracy rate.**

Turning the trimmer condenser changes its capacity as shown in the diagram.

The trimmer condenser has been adjusted at the factory so as to let the watch gain when it is turned clockwise and vice versa. Whenever adjustment is needed, however, turn the trimmer condenser while examining the gain and loss by the Quartz Tester.

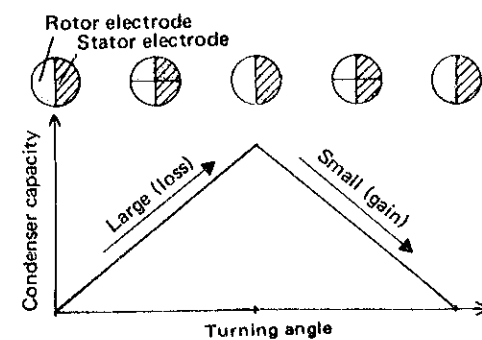

All procedures of Disassembling, Reassembling, Checking and Adjustment are completed.