

CITIZEN®

Setting Instructions for Movement Calibers C020, C021, C023, C026, C027, C029

Contents

1. OUTLINE
2. USE OF THIS WATCH
3. NOMENCLATURE AND IDENTIFICATION OF WATCH COMPONENTS
4. SETTING THE ANALOG TIME
5. SETTING THE DIGITAL TIME
 - a. Time Display System
 - b. Time, Calendar and Alarm Setting
6. STOPWATCH USE
7. CHANGE OVER BETWEEN THE TIME DISPLAY AND DIVE SYSTEMS
8. CHANGING OVER TO THE DIVE METER SYSTEM
9. EXPLANATION OF THE DIVE METER SYSTEM
10. HOURLY CHIME/ALARM MONITOR
11. POWER CELL LIFE INDICATOR
12. USE OF THE REGISTER RING
13. HOW TO READ THE NON DECOMPRESSION LIMIT VALUES
14. SPECIFICATIONS
15. HOW TO CARE FOR YOUR WATCH.





1. **OUTLINE**

This series of movements (C020, C021, C023, C026, C027, C029), are the worlds first multifunctional movement used in a dive watch that has an electronic water-depth meter built into it. It can resist water to 20 bar, or 666 feet.

2. **USE OF THIS WATCH**

Notes on Use

- The water dept meter was originally designed for use in Sea water. Therefore, then it is used in a lake or in fresh water, the displayed value is slightly different from that in sea water. (Specific gravity of Sea Water is 1.025)
- To ensure water-resistance at a depth of 200 meters (666 feet), be sure to replace the gaskets, including push button gaskets and have the watch water tested at least at each battery change. If you use the watch in salt or chlorinated water, more frequent changes may be necessary.
- This watch CANNOT be used as a substitute for an accompanying dive instrument or as a preventative measure against water hazards
- Do not use the dive meter in the following environments
 - i. Where the altitude is more than 3,000 meters (10,000 feet)
 - ii. Where there is a substantial change in atmospheric pressure or temperature after changing over to the dive meter system mode, depth display may show more than 1 meter (3 feet) even while on the ground. IN this case, the dive meter system mode will not change over to any other mode. To obtain proper operation of the watch, set the time display and dive meter systems once again by pushing the (R), (S) and (M) buttons at the same time.
 - iii. Where temperature is beyond the +10°C (+50°F) to +40°C (+104°F) When the watch is used in the above mentioned environments, the depth meter mode may be over 1m (3ft) even while on the ground. In these cases, return the watch back to the effective operating temperature ranges.
- If the depth meter mode returns to 0m (0ft), the display is found in the maximum depth and dive time memory Accordingly, if it is feared that the depth meter will return to 0m (0ft), summon the maximum depth memory mode immediately before diving and then summon the depth meter mode.
- Of the depth meter mode does not return to 0m (0ft) a substantial temperature change is thought to have taken place. In this case, refer to the preceding item iii.

* These phenomena are not deemed are problems. If the above instructions are observed with the users environments in mind, correct measurement of depth is possible.

Notes on Diving

Before Dive

- Make sure that the colon (:) on the time display in the digital section does not flicker on and off
 - *before diving, be sure to check when to replace the power cells.
- Make sure that the crown has been firmly screwed in place
- Make sure that there are not cuts, cracks or scratched on the crystal
- Make sure the band is in good condition, and not cracked or worn out.
- To get more accuracy in depth measurement, check the cell on the dive meter system after dipping the watch in water for 2 minutes. If there is s big temperature difference between the surface and water temperatures, be sure to change over to the dive meter system on the surface. (If changing over in the water at big temperature differences, accuracy may be affected.)
- When the depth meter mode is shown, make sure that the display is correct.





During dive

- Do not operate the crown when the watch is wet.
- Be careful not to bump the watch against hard objects when diving
- When the time display system is operation, the alarm for the time display system does not sound. This is designed to prevent alarm sound misunderstandings while diving.
- In the water, a clear alarm sound may not be heard due to various conditions and environments in which the watch is used. When using the alarm, pay attention to wet suit and arm position.

After Dive

- Rinse the watch with fresh water to remove salt water and any dirt that may have accumulated during the dive.
- Thoroughly wipe and dry the watch after rinsing with fresh water.
- Do not touch the watch with a sharp object to clean or remove foreign matter from the sensor.
If there is foreign matter on the sensor, remove is with fresh water. Pay special attention to ensure the sensor is not exposed to any chemicals such as alcohol, gasoline, paint thinner, etc.

Notes on Safety

- When the watch's additional safety function (fail safe operating) begins working, immediately stop using the watch and have it checked at your closest Authorized Citizen Service Center.
When the dive meter system functions do not operate properly, or when the colon (:) in the digital display flickers on and off (when the power cell indicator is in operation), the change-over from the time to dive meter system cannot be made. This is because the watch power is low which triggered the fail safe operation to action.
* If you find anything abnormal with the watch operation, other than previously described, immediately stop using the watch and have it checked by your nearest Authorized Citizen Service Center.
- If the watch is to be used during a dive, be sure to be properly trained in dive safety and procedures. This watch cannot be used as a primary dive instrument nor substituted for an accompanying diver or as a preventative measure against water hazards.
- This watch displays the water depth at up to 80m(260ft)
When the depth is beyond this, there is no value displayed.
- For safety reasons, we recommend this watch be used in sports diving environments up to 40m (133ft)





3. Nomenclature and identification of watch parts

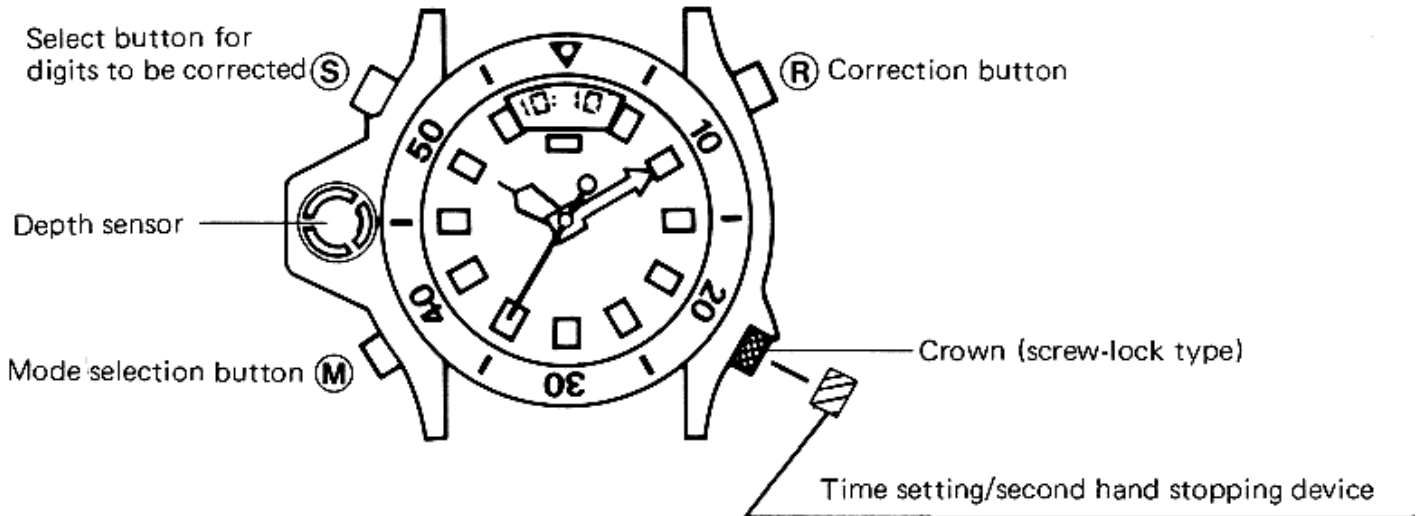

4. SETTING THE TIME

Set the Analog (hands) time

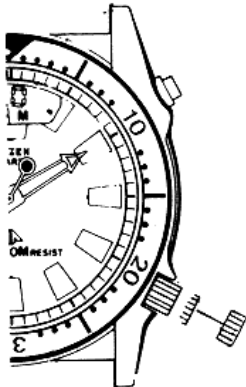

- The crown is a screw down type locking it into place next to the case to help prevent the entrance of moisture. To set the analog time, first unscrew the crown in a counter clockwise motion to release it from the case. Pull the crown out 1 click and turn to set the current time.
- After setting the time, push the crown in one click. While applying gentle pressure towards the case, turn the crown in a clockwise motion to lock it onto the case.





5. USING THE DIGITAL DISPLAY

Notes on nomenclature for the digital display instructions

- ❖ The circled portions flash
- ❖ A confirmation sound is heard when operating the button marked with
 - the digital section contains the time and dive meter systems

Time display system

A). Changing to the Digital Time Display system.

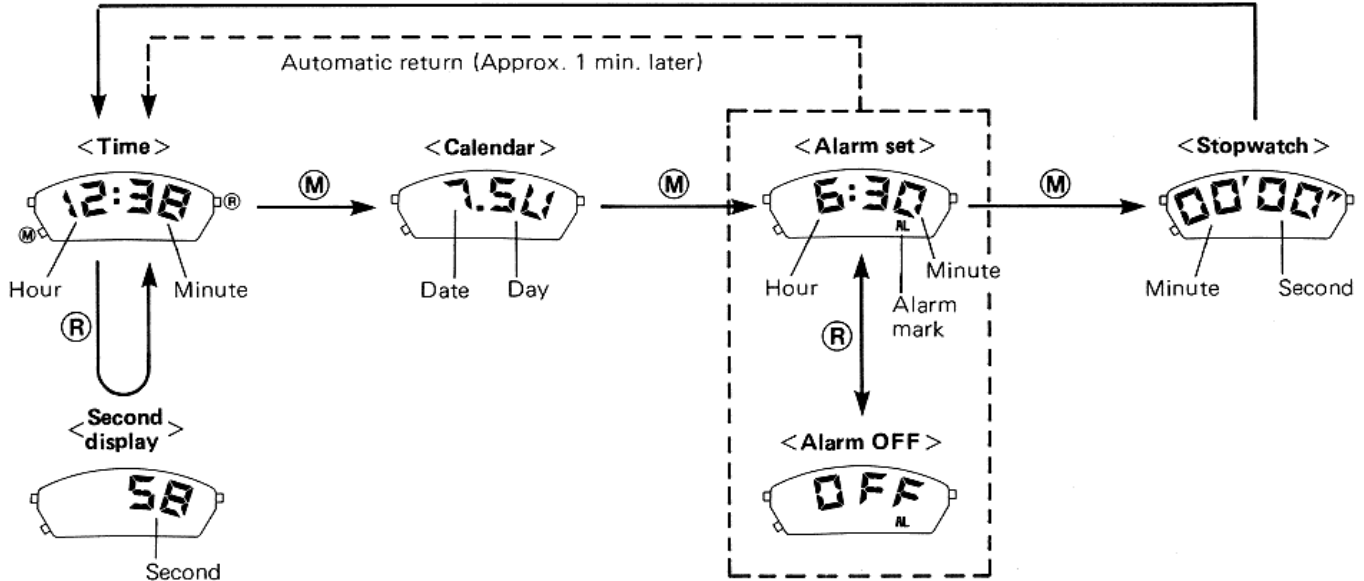

(How to read seconds)

Seconds are displayed only while the (R)(upper right) button is pressed in the time display mode.

Whether the alarm is ON or OFF, if the alarm display is left displayed for about 1 minute, the time display will automatically return and replace the alarm display (Automatic Return Feature)

B) Time, Calendar and Alarm Setting Methods

How to set the seconds

While in the time display, push the (S)(upper left) button until the second display flashes on and off. Press the (R)(upper right) button to correct the seconds

Note: if the (R)(upper right) button is pushed when the second display is between 30 and 59 seconds, the digital minute will advance by 1 minute.

How to set the time, calendar and alarm

1. To set the time, calendar and alarm, push the (S)(upper left) button in each respective display mode until the correction mode is obtained (digits flashing)
2. Any mode can be independently corrected. Select the mode that you wish to correct by pressing the (S)(upper left) button. The mode to be corrected will flash on and off.

Set the mode with the (R)(upper right) button.

Each push of button (R)(upper right) advances the figures by one, a continuous push of button (R)(upper right) will cause the digits to advance rapidly.
3. After the setting is finished, the mode returns to the previous state in which it had been set by pushing the (M)(lower left) button. (Instant manual return)

Any time a particular mode is left displayed for 4-5 minutes, it will automatically return to the previous state in which it had been set. (Automatic return)





- The 12/24 hour switching function is interlocked with the time display system
- If the alarm button (R) (upper right) is pushed while the <ALARM SET> is displayed, the alarm will turn OFF, thus the <ALARM OFF> and <ALARM SET> will be displayed
- "P" mark appears only for PM in the 12 hour display
No mark has been provided to indicate AM (prior to noon)
- When the dive meter is in use, the buzzer does not sound even though the current time reaches the Alarm Set time.

How to set the time

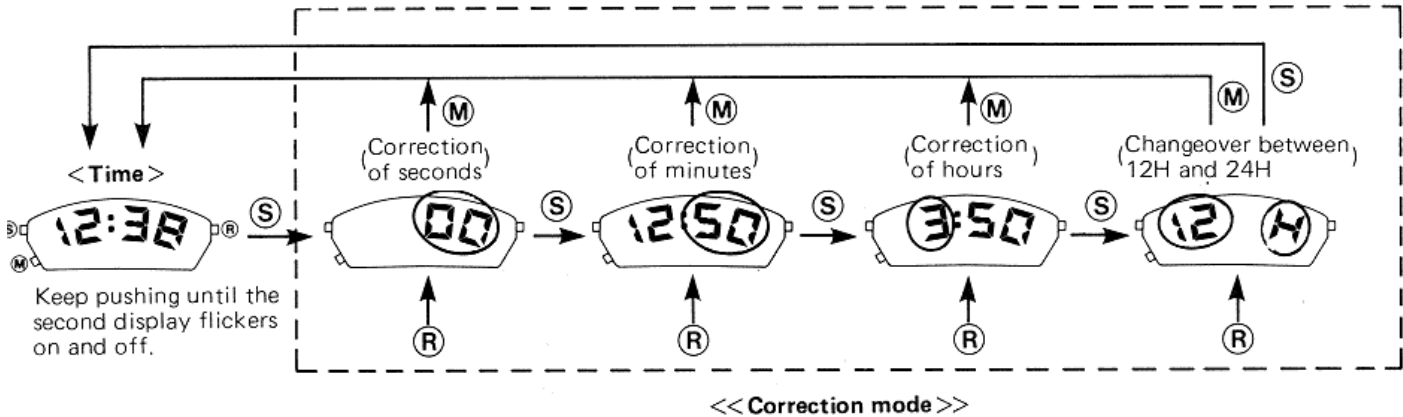

How to set the calendar

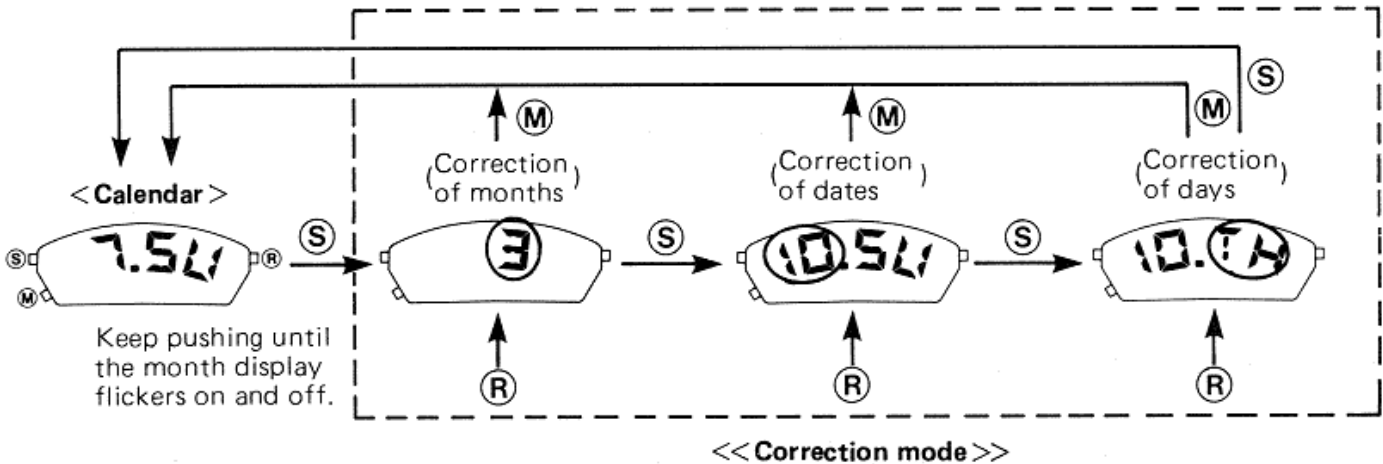



How to set the alarm

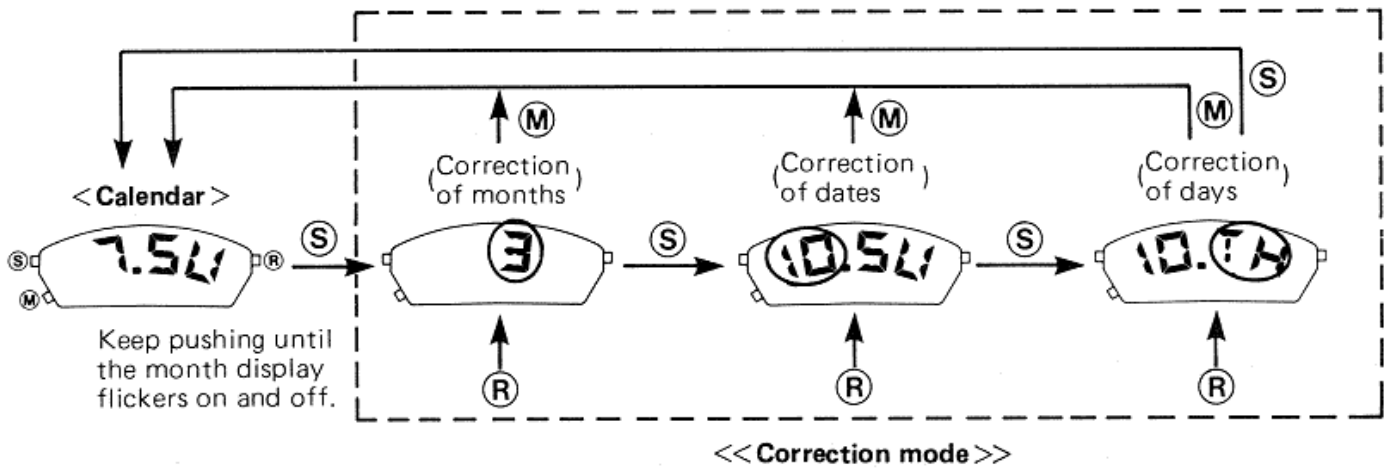

6. STOPWATCH USE METHOD

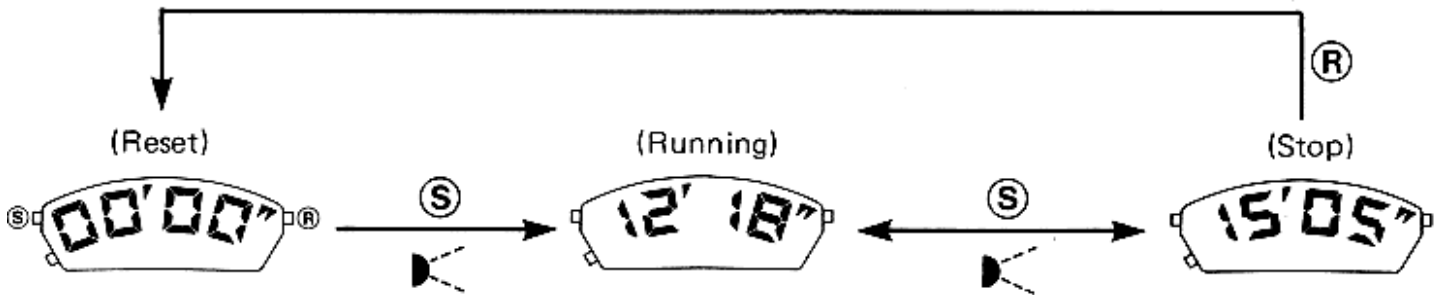

- ❖ The stopwatch measures up to 59 minutes and 59 seconds at intervals of 1 second. When 60 minutes is reached, the stopwatch resets to 00 minutes, 00 seconds and starts recounting from 0
- ❖ If the (S)(upper left) button is repeatedly pushed during the time counting, the stopwatch works as an integrated meter going back and forth between "running" and "Stop" over and over again.
- ❖ A confirmation tone is heard of the (S)(upper left) button is pushed when the stopwatch starts or stops running.





7. Changeover between the time display and dive meter systems

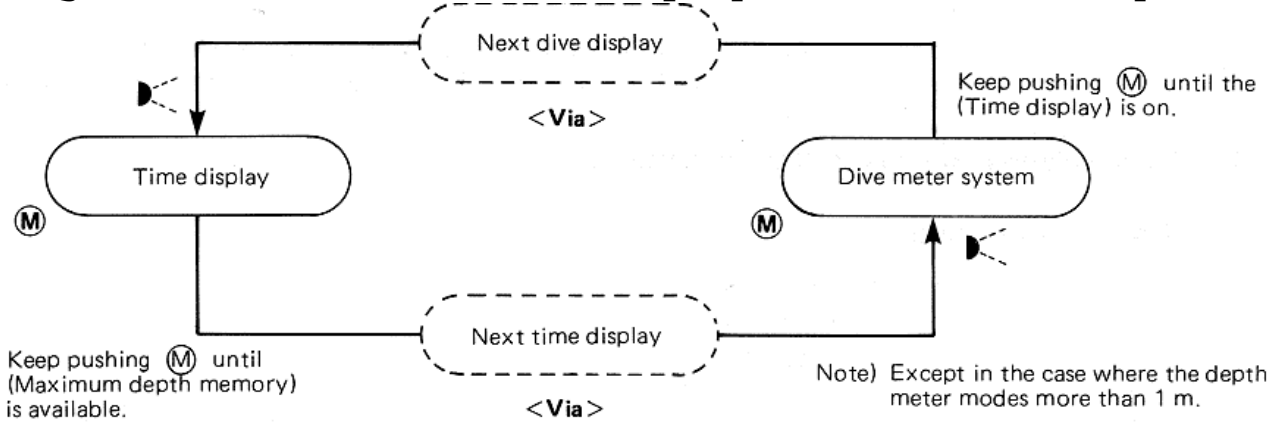

- When changing over between the time display and dive meter systems, keep pushing the (M)(lower left) button until a confirmation tone is heard in any mode (except correction mode) Example:
 Time Display System Dive Meter System
 <Time Display> -> <Calendar Display> -> <Maximum depth Memory>
 Dive Meter System Time Display System
 <Maximum Depth Memory> -> <Depth Alarm> -> <Time Display>
- If the dive meter system does not operate properly, the time display will not be replaced by the dive meter system (fail safe operation system) At this time, the DM mark on the display flashes on and off. In this case, have it checked by the nearest Authorized Citizen Service Center.
- When the power cell life indicator is in operation, the dive meter system cannot be called up. (Fail safe operation system)

8. Changing over to the dive meter system

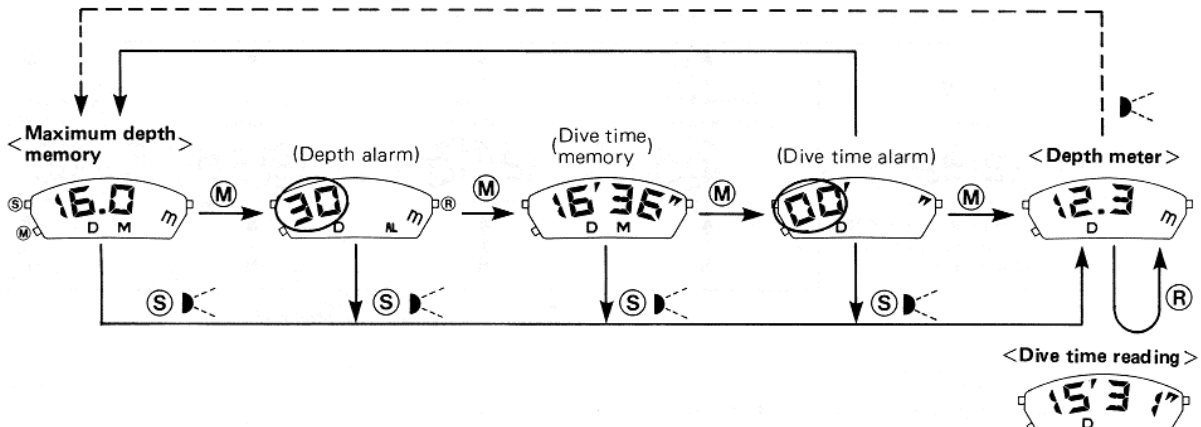

- The depth meter is displayed by pushing the (S)(upper left) button in any mode of the four-numbered 1 to 4.
- To change the mode from the depth meter to the maximum depth memory, push the (S)(upper left) button when the display dept value is 0m(0ft).
- If the depth value of 0m(0ft) remains displayed for 30 to 40 minutes, the Maximum depth memory will automatically return to the mode. (Automatic Return)
- The depth meter mode is replaced by the dive time mode when the ® button is pushed.





A. Maximum Depth Memory (What is the maximum depth memory)

- It is the maximum dive depth which is automatically memorized
- The maximum dive depth is shown by changing over to the maximum depth memory mode after finishing the dive
- The maximum depth memory mode is replaced the depth meter mode. When more than 1m (3ft) of depth is measured, the maximum depth memory mode is reset and the new value of the maximum depth is memorized
*when the depth valued is under 1m (3ft), the previous maximum depth is not reset
- When more than 5M(17ft) of depth value is measured in a second, the value is deemed as abnormal and not memorized.

How to read the display

The maximum displayed value of the maximum depth memory is 80M (260ft)
The maximum depth memory is displayed as follows:

<Display in meters>



- Display 0,1.0,1.1,1.2,.....80.0,--,--
- DM Mark -> Depth Memory

<Display in feet>



- Display 0,3,4,5,..... 260,--,--,

When the depth value is under 1.0m(3ft), the displayed figure is 0. The depth value is shown on a 0.1m(1ft) basis when it is over 1.0m (3ft).
When the depth value is over 80m (260ft) it is displayed as --,-(----)

B. Depth Alarm (What is the depth alarm?)

Example

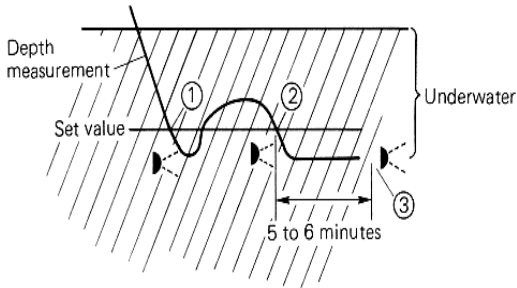

When the diving depth exceeds the previously set value, a buzzer sounds from 1min to 1min, 10 seconds. The buzzer stops sounding when the diver goes up towards the water surface beyond the set value
When the diver goes deeper than the set value, the buzzer starts sounding again (2).
In addition, if the diver stays at a depth below the set value for 5 to 6 minutes, the buzzer starts sounding (3).



**(How to set)**

Set the alarm when <Depth Alarm> is displayed. Each push of the (R)(upper right) button increases the figure by one. Quick forwarding of the setting is possible by continuously pushing the same button.

Alarm depth can be set at intervals of 1m (3ft). If the alarm depth is set at 80m(260ft), the depth alarm mode will return to --(---).

When the depth alarm mode is --(--), the buzzer does not sound.

To stop the buzzer, push either the (S)(upper left), (R)(upper right) or (M)(lower left) buttons.

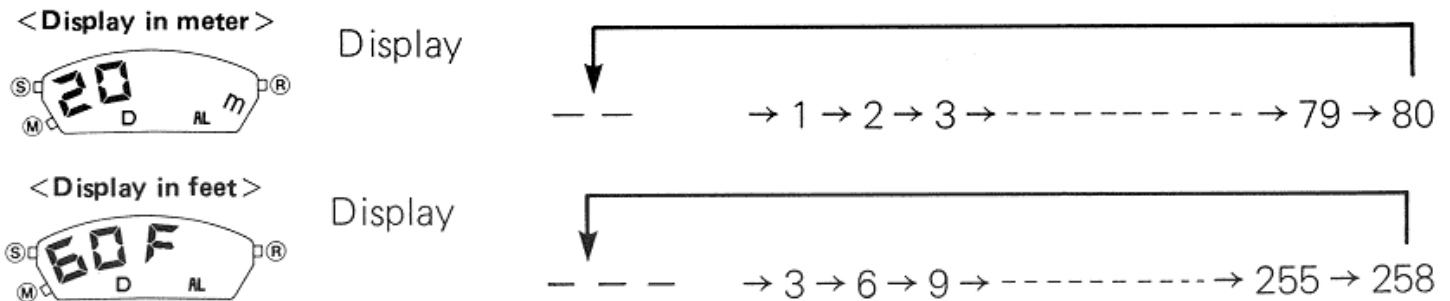
**C. Dive Time Memory (what is the dive time memory)**

- It is time needed for diving at a depth of more than 1m(3ft), which is automatically memorized. As long as the depth meter mode is not cancelled, the dive time is automatically added and memorized.
- The dive time is displayed by changing over to the dive time memory mode after finishing the dive
- The dive time memory mode is replaced by the depth meter mode. When more than 1m(3ft) in depth is measured, the dive time memory mode is reset and the new value of the dive time is memorized. However, when the measured depth is under 1m(3ft), it is not reset.

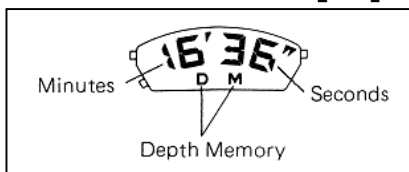
How to read the display

Dive time up to 59 min, 59 sec, is memorized at intervals of 1 second. After memorizing 59 min, 59 sec, the display begins again with 00 min and 00 sec.





D. Dive Time Alarm

What is the dive time alarm?

If a certain period of time was previously set for diving, a buzzer sounds for 30-40 seconds when the diver stays in the water beyond the set time. To stop the buzzer, push either the (S)(upper left), (R)(upper right) or (M)(lower left) buttons.

However, diving time at a depth of 1m(3ft) or less cannot be measured.

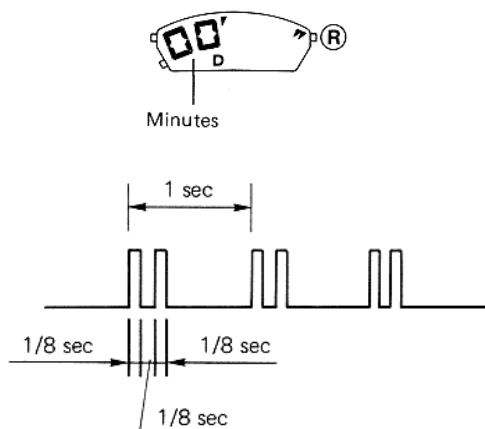

- With each push of the (R)(upper right) button, the time advances 5 minutes. Quick forwarding is obtained by pressing and holding the (R)(upper right) button.
- The dive time alarm can be set at 60 minute in intervals of 5 minutes. Every second on the second, the alarm sounds for 1/8 second. Moreover, it repeatedly sounds for 1/8 second at intervals of 1/8 second. This remains in affect for 30-40 seconds.

E. Depth Meter

What is the Depth Meter?

It is a function of measuring the depth of a dive.

When measuring a depth of more than 1m (3ft), the depth meter mode is not replaced by any other mode even when the (S)(upper left) button is pushed (fail safe operation.)

How to read the display

<Display in meters>



<Display in feet>



- The maximum display value of the dept meter is 80m (260ft)
- Depth is displayed as follows;
 <Display in meters> 0->1.0->1.1->1.2->.->80.0
 <Display in feet> 0->3->4->5->...260->-----
- When the figure (0) is displayed, it flashes
- If the figure (0) remains displayed for 30-40 minutes, the display will automatically return to the maximum memory mode (automatic return).

F. Dive Time Reading

What is dive time reading?

- It is a function of measuring the dive time at a depth of more than 1m(3ft)
- This measurement automatically starts at a depth of more than 1m(3ft) and automatically stops at a depth of less than 1m(3ft)

How to read the display

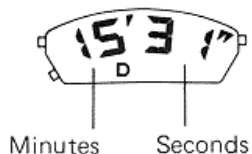

- When the depth meter mode is 0m(0ft), the dive time reading is not carried out.
- Up to 59 min, 59 sec. Of dive times is measured at intervals of 1 second
 After measuring 59 min, 59 sec, the measurement starts again from 00 min,00 sec.





9. EXPLANATION OF THE DIVE METER SYSTEM

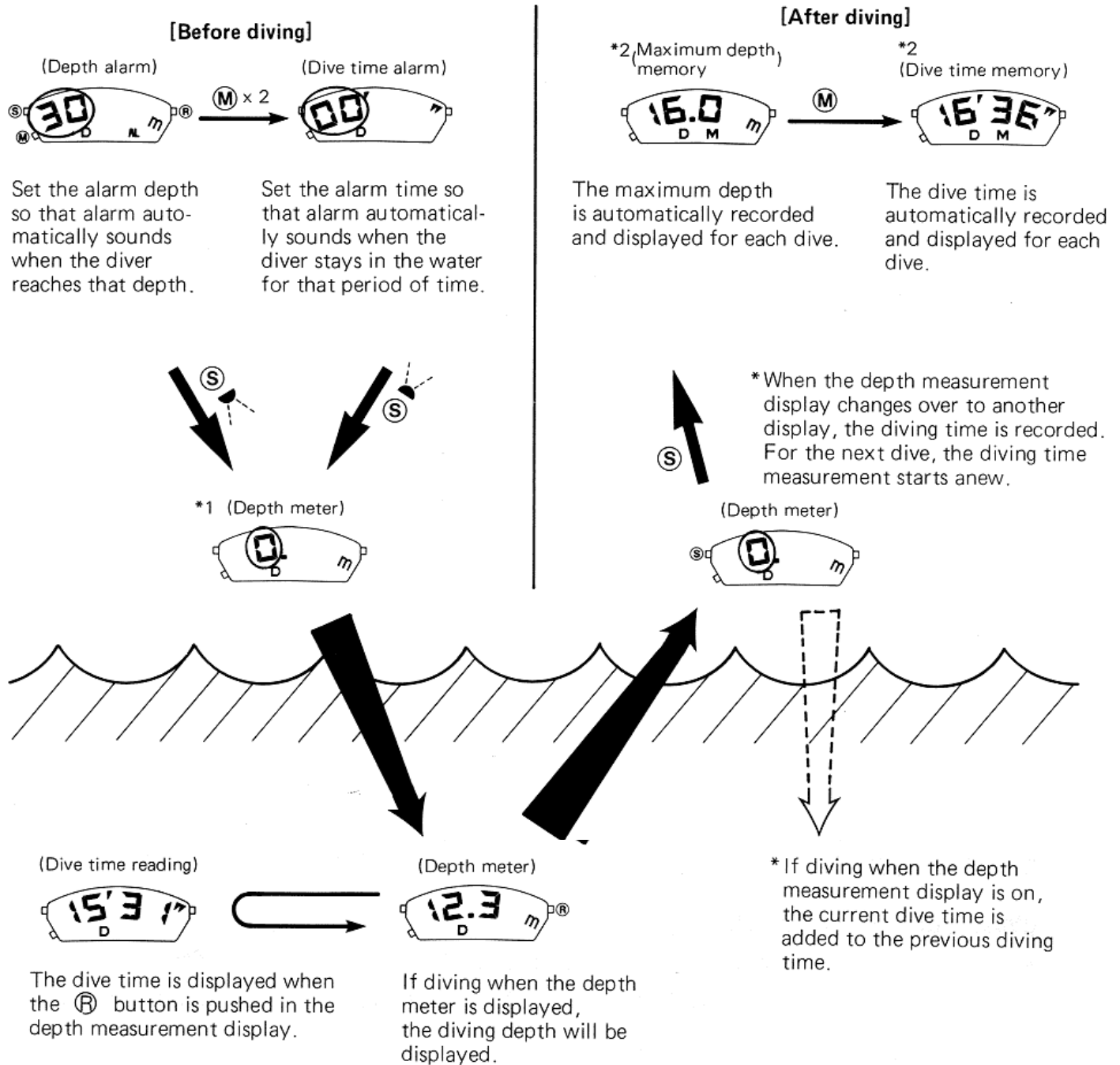

1. The dive meter system automatically begins measurement when the diver reaches a depth of 1m (3ft) with the depth meter continuously displayed and it automatically stops when the diver surfaces to a level less than 1m(3ft) in depth.
2. When the diver reaches a depth of 1m(3ft), the previous records of the maximum depth and dive times are reset and a new measurement begins.





10. HOURLY CHIME/ALARM MONITOR

To turn the hourly chime ON or OFF, push the (S)(upper left) and (R) Upper Right buttons at the same time in the time mode. When the hourly chime is turned on, the buzzer continues to sound while the two buttons are pushed. When the hourly chime is turned OFF, the buzzer sounds for the fixed previous time. ALARM MONITOR

11. POWER CELL LIFE INDICATOR

The colon in the digital section flashes on and off when the power cell is in low charge state and needs replacing. Depending on use, the analog section may stop operation before the power cell indicator starts operation.

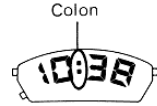

12. USE OF THE REGISTER RING

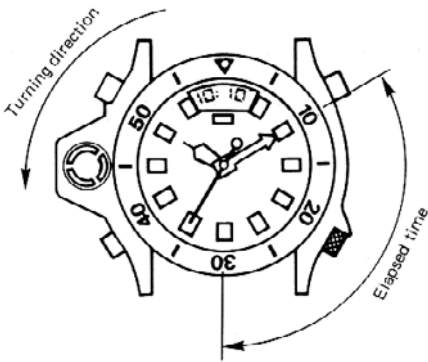

The register ring can be turned in only one direction, counter clockwise. An anti-reverse mechanism with a click sound is provided in order to protect the above mechanism. Do not use force to turn the bezel in a clockwise direction. Otherwise, the case may become damaged and need replacement. Set the triangle /\ mark to the position of the minute hand as the dive start time to read the elapsed time. The ring can be turned in units of one half minutes.

13. HOW TO READ THE NON-DECOMPRESSION LIMIT VALUES

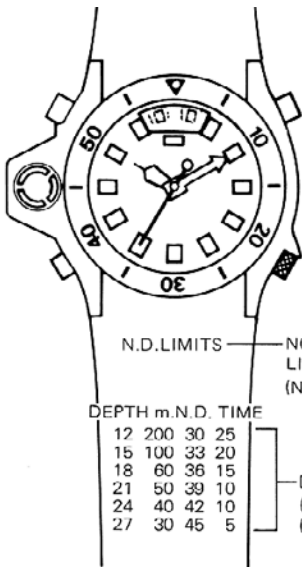

Depending on the diving depth, the diver may surface without decompression. A dive limit table may be noted on your watchband. This table indicates dive time limits for non-decompression diving.

Example:
21m 50min.....
This is understood as follows:
If the dive time does not exceed 50 minutes at a depth of 21 meters, the diver can surface without decompression.

N.D. LIMITS			
NO. DECOMPRESSION LIMITS			
(No decompression limits)			
DEPTH m.	N.D.	TIME	
12	200	30	25
15	100	33	20
18	60	36	15
21	50	39	10
24	40	42	10
27	30	45	5

12M - 200 min	30m - 25 min.
15m - 100 min.	33m - 20 min.
18m - 60 min.	36m - 15 min.
21m - 50 min.	39m - 10 min.
24m - 40 min.	42m - 10 min.
27m - 30 min.	45m - 5 min.





14. Specifications

Movement Caliber Number	C020, C021, C023, C026, C027, C029 Combination Analog Digital Movement
Accuracy	Within +/- 20 seconds per month (when worn at normal temperatures of 5°C to 35°C/(41°F to 95°F))
Operating temperature range	Watch operating temperature range : +10°C +40°C (50°F to 104°F)
Depth Meter Accuracy (at uniform temperature)	C021, C023, C026, C029 +/- (3% of displayed value + 1ft) C020, C027 +/- (3% of displayed value +0.3m)
Analog Display	Hours, Minutes, Seconds
Time	Seconds, minutes, hours, city name, daylight savings time, A/P
Calendar	Month, Day, Date
Alarm	Hour, Minute, P (Displayed in the afternoon when the 12-hour display is used)/OFF
Stopwatch	Minute, second (displays up to 59 minutes, 59 seconds)
Maximum Depth Memory Display	Displays from 0m(0ft) to 80m(260ft). When depth is under 1m(3ft), the displayed value is 0M(0ft). Depth is displayed on a .01m (1ft) basis.
Depth Alarm	Can be set at up to 80m (258ft). Setting can be made on a 1m (3ft) basis.
Dive Time Memory	Minute, Second (displays up to 59 min, 59 sec.)
Dive Time Alarm	Can be set at between 5min and 60min. (Setting can be made at intervals of 5 minutes.)
Depth Meter	Display from 0m(0ft) to 80m(260ft). When depth is under 1m(3ft), the displayed value is 0M(0ft). Depth is displayed on a .01m (1ft) basis.
Dive Time Reading	Minute, Second (displays up to 59min, 59 sec.)
Additional Functions	<ul style="list-style-type: none"> • Hourly Chime • Power Cell Life Indicator • Alarm Monitor • Fail Save Operation System
Battery Life	Battery life averages about 2 years. This will vary depending on the age of the watch, and features used.
Battery	Utilizes 3 pieces of SR927W
Measurement System Notes	Movement Calibers C020 C026 Display metric measurements Movement Calibers C021, C023, C027, C029 Display standard (feet) measurements

DISPLAY FUNCTION

Digital Display



PRECAUTIONS ABOUT CARE AND HANDLING OF WATCHES

TEMPERATURE CARE

Avoid temperature extremes. Exposing your watch to high temperatures, such as placing it on the dashboard of a vehicle or use in a hot tub, may cause the watch to malfunction, shorten battery life or damage certain components. Leaving the watch in extreme cold temperatures may cause irregular timekeeping until the watch returns to normal operating temperature.

SHOCK-RESISTANT

The watch may be worn while playing golf or other activities, but avoid severe shocks such as dropping it on a hard surface.

MAGNETIC-RESISTANT

No problem should occur from using the watch around ordinary household electric appliances such as TV sets or stereos. Keep away from magnets.

CHEMICAL/GAS RESISTANT

Do not expose the watch to chemicals or gases for long periods.

WATCH CLEANING

Stains, waterspots and accumulated dirt on the case, crystal or band should be removed with a soft cloth to prevent damage and premature wear.

HANDLING OF WATER-RESISTANT WATCHES

Although water-resistant watches are warranted, steps should be taken to avoid damage that may result from accidents or mishandling:

- Do not operate the crown or push-button in the water or while the watch is wet. Tighten screw lock crown completely.
- Should the watch become immersed in water, dry it off right away. If the watch comes in contact with salt water, be sure to rinse it thoroughly in warm fresh water to remove any trace of salt.
- If a watch is wet from cleaning or by accident, never store it in a closed container. It should be dried immediately or taken to a watchmaker or jeweler if moisture is inside the case to prevent damage from rust.
- Vital components necessary to resist the entrance of moisture deteriorate with time and use. Gaskets, crowns and other materials should be replaced every year or two to ensure

that water resistant quality remains at factory specifications.

CARE FOR METAL BRACELETS

To extend the life and maintain the good appearance of the metal watch bracelet, the following recommendations are given:

- Be aware that since the watch and bracelet is worn next to the skin, it collects dust and perspiration and becomes soiled if not cleaned regularly. This is particularly true of the inner parts of the links or mesh of the bracelet.
- Soil and rust, when present in a bracelet, are dissolved by perspiration and can cause staining of cuffs and irritation of the skin in some instances.
- Heavy perspiration should be wiped off the watch and bracelet with a soft dry cloth. The bracelet should be cleaned occasionally by using an old toothbrush and warm soapy water after which the soap is thoroughly rinsed with clear water and the bracelet dried completely. The foregoing manner of cleaning should not be done if the watch is not water-resistant but should instead be done by your jeweler.





CARE FOR STRAPS

LEATHER

- Heavy perspiration, if not removed from a leather strap, can wash out the natural oils and cause the leather to become dry and deteriorate. Any moisture should be blotted with a soft dry cloth or paper towel and the strap allowed to dry naturally.
- Salt residue and soil can be removed from the leather by cleaning with a dampened soft cloth and mild soap or saddle soap.
- Occasionally, the inside surface of the strap should be cleaned by using a soft cloth dampened with alcohol.
- The strap should always be worn a little loosely (one finger space between wrist and strap) to allow air to circulate thus causing any moisture to evaporate.

RUBBER

- Rubber straps should be washed frequently with mild soap and warm water using a soft brush.
- Thorough cleaning, using the same method, should especially be done after use in salt water.
- Solvents, oils, perspiration, tanning lotion and salt can cause rubber to deteriorate if not removed.

Marking on the Dial	Marking on the Caseback	 Face washing, splashes, sweat, raindrops, etc.	 Swimming	 Skin diving (diving without air tanks)	 Scuba diving (diving with air tanks)	Water-resistant characteristics
NONE	NONE	NO	NO	NO	NO	Non water-resistant watch and must be kept away from water.
NONE	WATER RESIST	OK	NO	NO	NO	An ordinary water-resistant watch and can withstand splashes, sweat, rain-drops and etc. for daily life use.
WR100M WR10bar WR150M	WATER RESIST	OK	OK	OK	NO	For frequent use with water. It is not specially designed for scuba diving.
WR200M	WATER RESIST	OK	OK	OK	OK	For skin and scuba diving. Usable up to the respective indicated depths.

See instruction book for further information