

# TECHNICAL GUIDE

CAL. Y770A

## DIGITAL QUARTZ

### CONTENTS

I. SPECIFICATIONS.....	1
II. CIRCUIT BLOCK SCHEMATIC.....	1
III. DISASSEMBLING, REASSEMBLING AND CLEANING.....	2~3
1. Disassembling and reassembling of the module.....	2
2. Cleaning.....	3
IV. CHECKING AND ADJUSTMENT.....	5~13
A. Check battery voltage.....	8
B. Check battery conductivity.....	8
C. Check current consumption.....	9
D. Check water resistance.....	10
E. Check contact of C-MOS-LSI — liquid crystal panel.....	10
F. Check liquid crystal panel and circuit block.....	10~11
G. Check accuracy.....	11
H. Check functioning.....	12
I. Check conductivity of switch component.....	12
J. Check bulb condition.....	12
K. Check alarm function.....	13
V. DISPLAY FUNCTION.....	14

## I. SPECIFICATIONS

Item	Cal. No.	Y770A
Display medium		Nematic Liquid Crystal, FEM (Field Effect Mode)
Liquid crystal panel drive system		1/2 multiplex
Display system		<ul style="list-style-type: none"> <li>•Time function (12/24-hour system)</li> <li>•Alarm function</li> <li>•Stopwatch function (1/100-second, 60-minute system)</li> <li>•Timer function (1-second, 60-minute system)</li> </ul>
Additional mechanism		<ul style="list-style-type: none"> <li>•Time signal</li> <li>•Sound demonstration (with alarm stop function)</li> <li>•Pattern segment checking system</li> <li>•Auto-calendar</li> <li>•Illuminating light</li> <li>•Interval timer</li> <li>•Auto-return feature</li> </ul>
Loss/gain		Loss/gain at normal temperature range. Mean monthly rate: Less than 15 seconds
Casing diameter		φ28.1 mm
Height		4.9 mm
Regulation system		Logical regulation
Measuring gate		10 seconds
Lithium battery:		Battery Life: Approx. 5 years MATUSHITA BR2016 (Voltage: 3.0V)

## II. CIRCUIT BLOCK SCHEMATIC

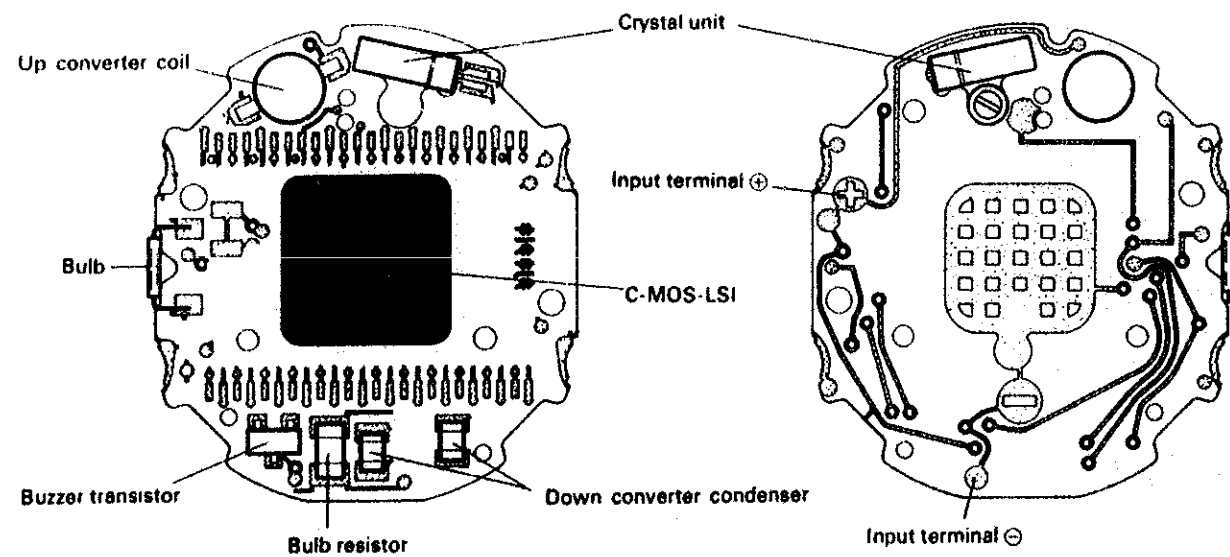

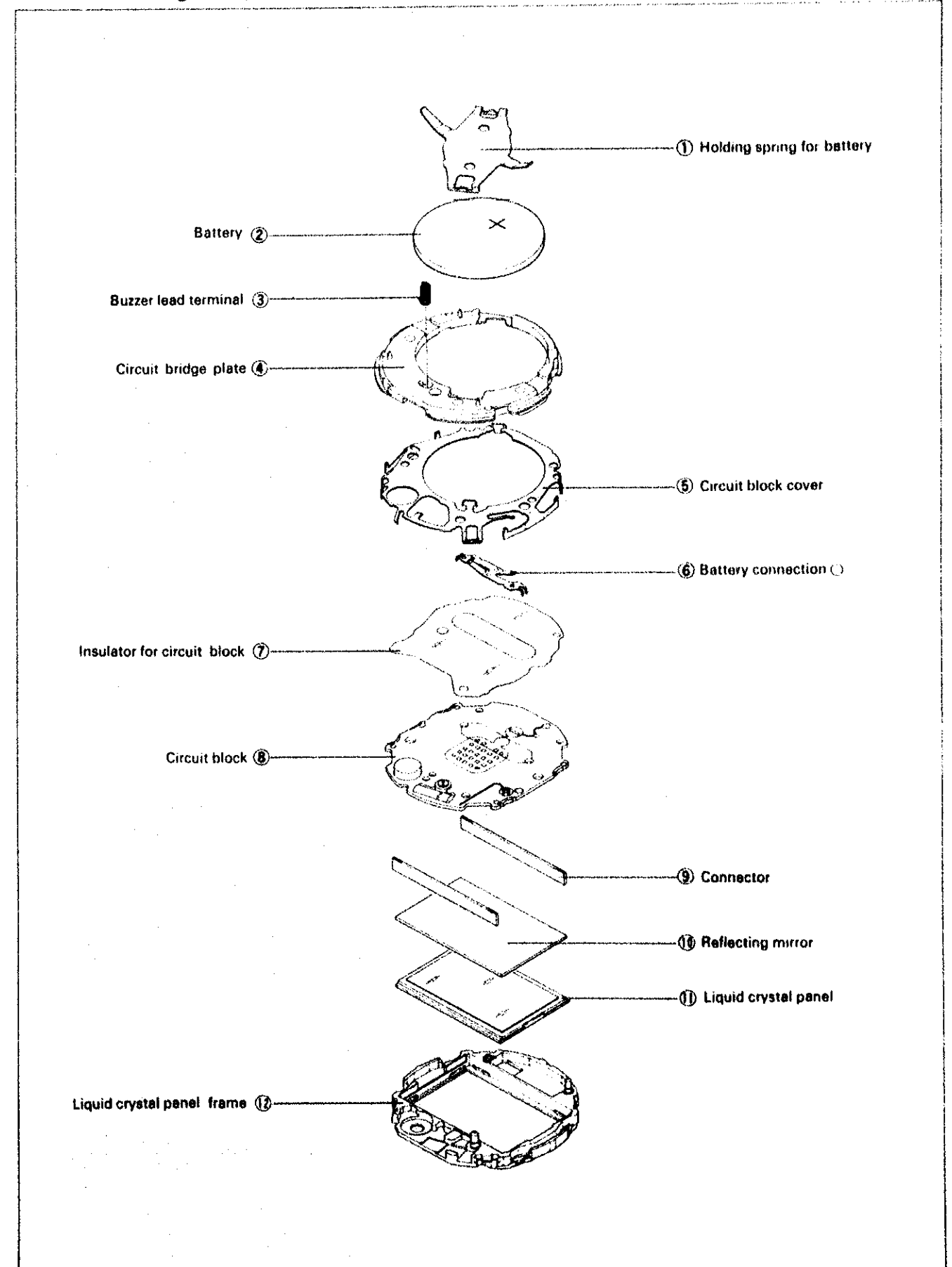

## III. DISASSEMBLING, REASSEMBLING AND CLEANING

### 1. Disassembling and reassembling of the module

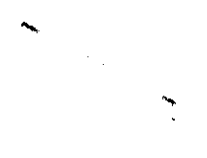

## 2. Cleaning

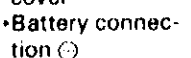
Name of parts	Cleaning	Drying	Solution	Remarks
Connector 	Rinse or wash with a soft brush	Warm air	Alcohol	<ul style="list-style-type: none"> <li>• Clean the contacting portion between the connector and liquid crystal panel and circuit block.</li> <li>• Never use benzene or trichloroethylene as these will melt the parts.</li> <li>• Do not set the connector until it is completely dry.</li> </ul>
Plastic parts • Panel frame 	Rinse or wash with a soft brush.	Warm air	Alcohol or benzene	
Metal parts • Holding spring for battery • Circuit block cover • Battery connection ⊕ 	Rinse and wash with a cleaner or wash with a soft brush.	Warm air or hot air	Alcohol, benzene or trichloroethylene	

### ☆ Parts that must not be cleaned

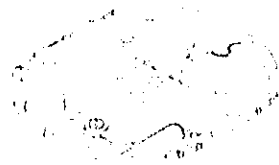

Circuit block

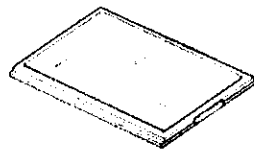

Liquid crystal panel

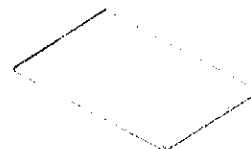

Reflecting mirror

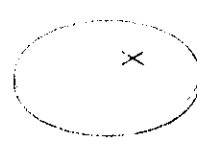

Battery

- Only the conductive portions should be wiped with a cloth moistened with benzene and dried with warm air.
- Remove dust and lint with a brush.
- Be careful not to scratch the front surface of the reflecting mirror.

## IV. CHECKING AND ADJUSTMENT

### 1. Guide table for checking and adjustment

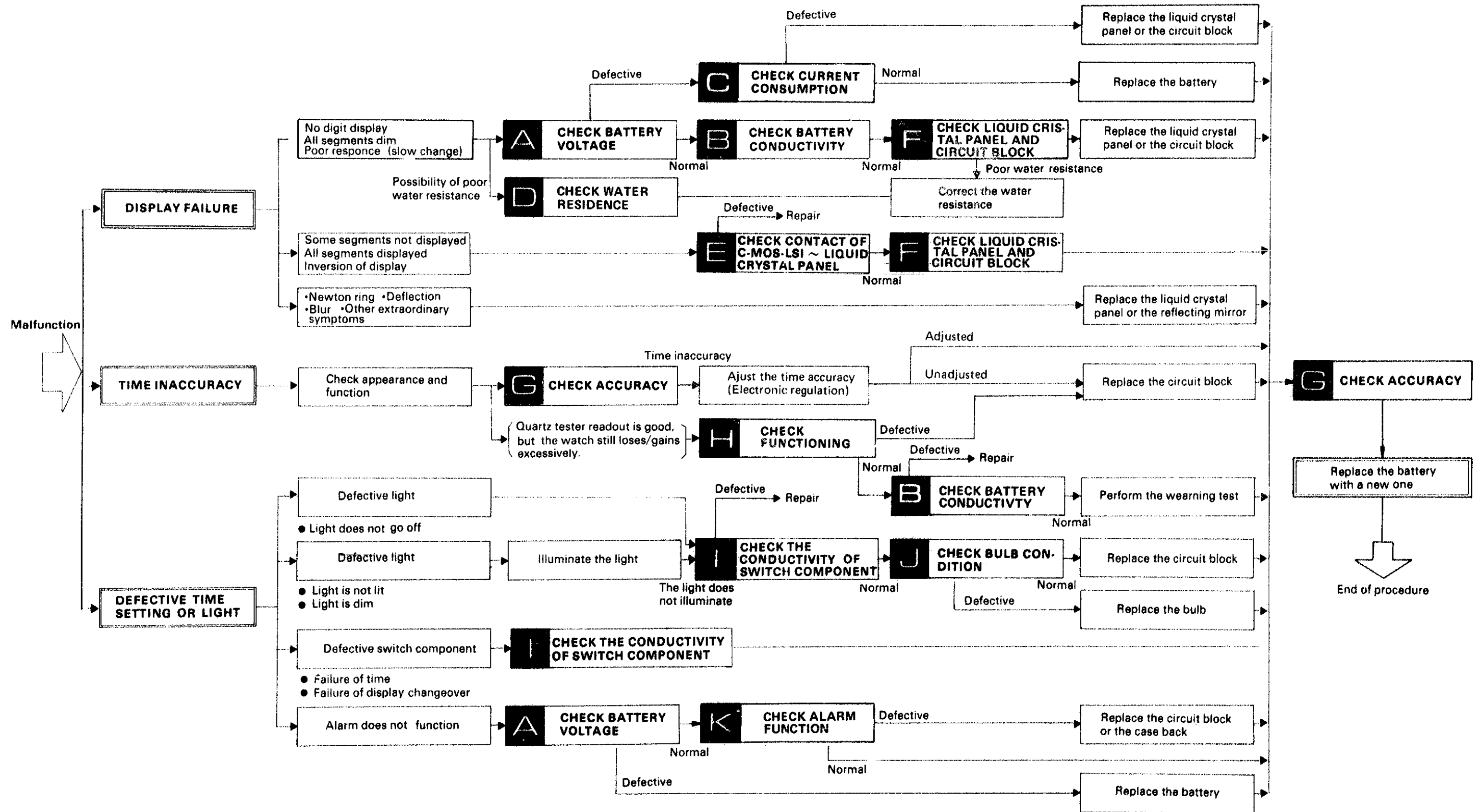

## 2. Relationship between the segments (Liquid Crystal Panel electrodes) and C-MOS-LSI output terminals

- A complete knowledge of how the segments (Liquid Crystal Panel electrodes) connected with the C-MOS-LSI output terminals is necessary for proper checking and adjustment.

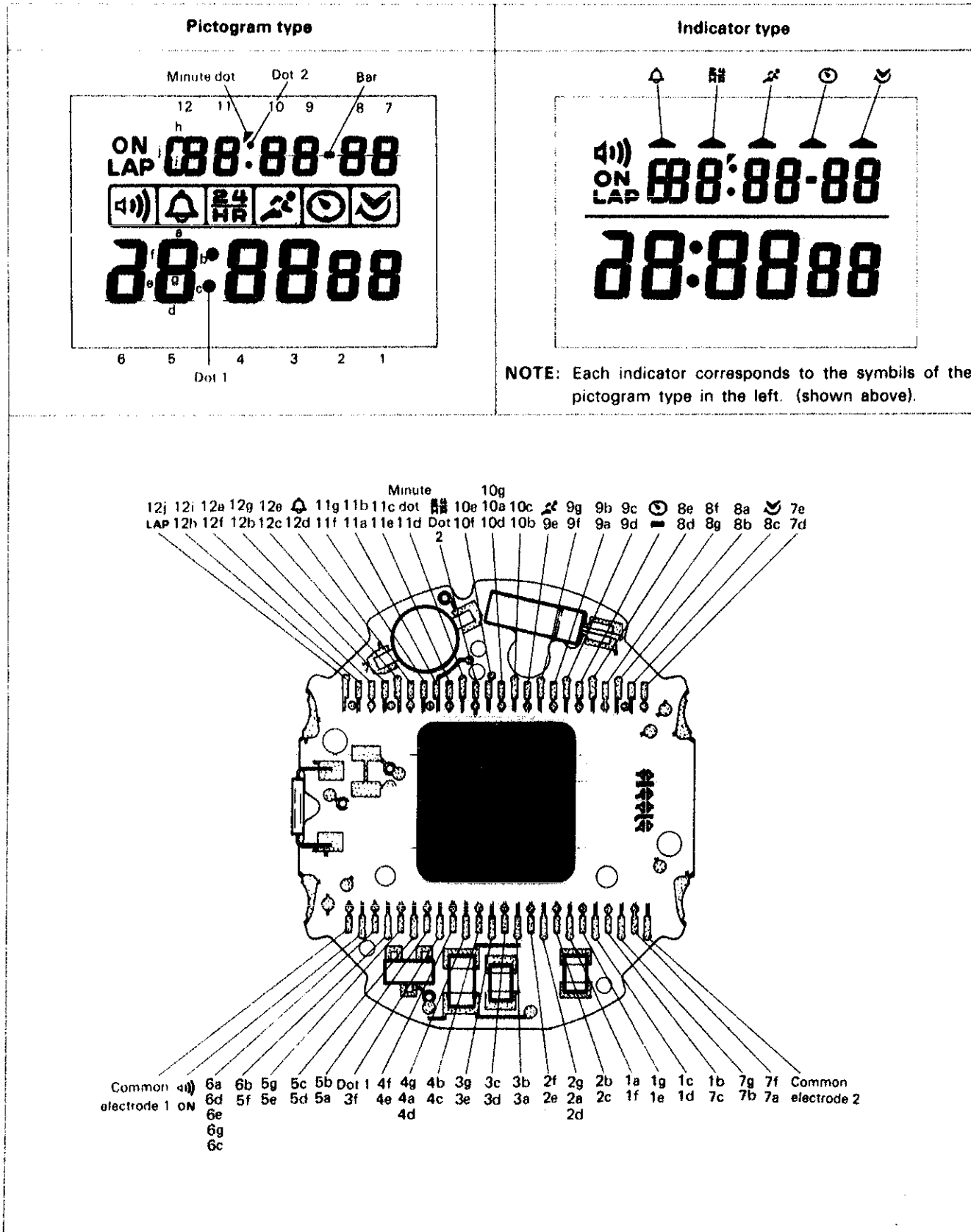

### [Pictogram type]

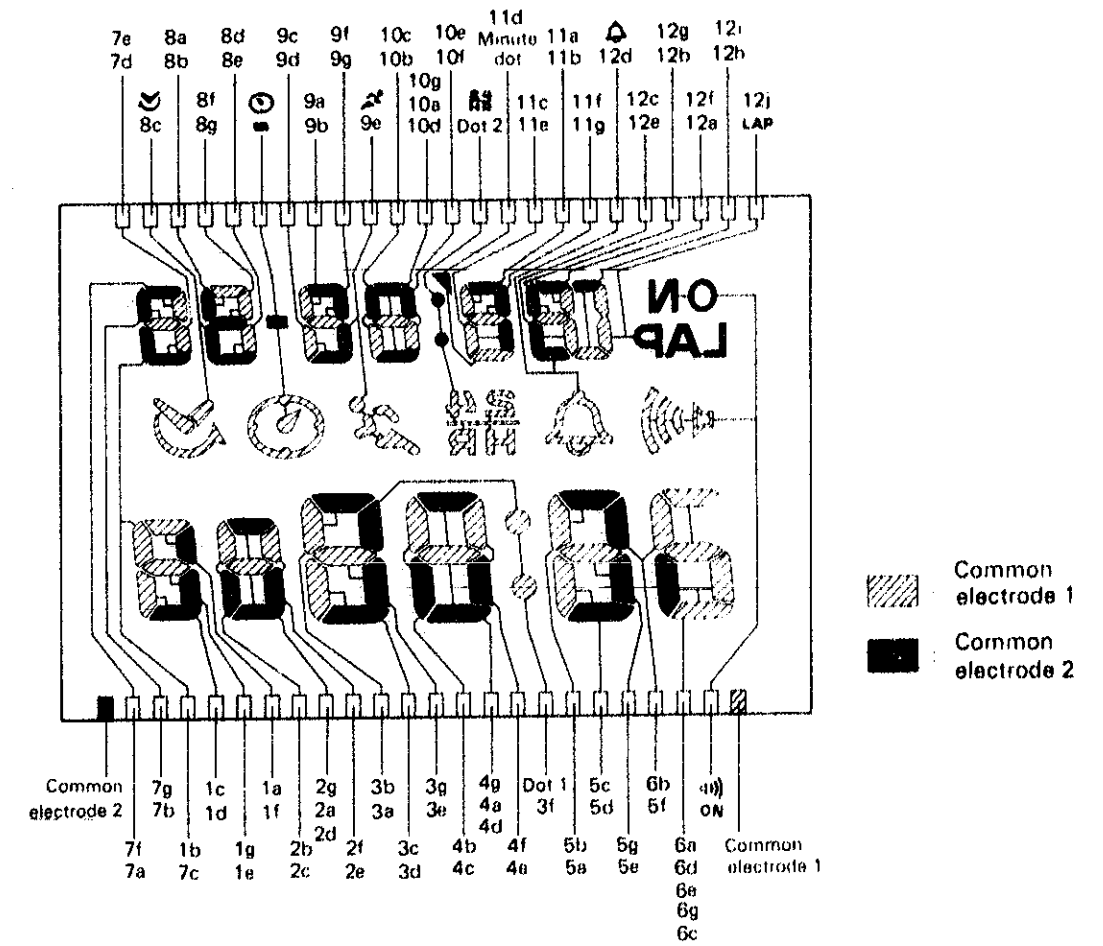

### [Indicator type]

The mode display mark and indicator differ from those of the pictogram type. The wiring and location of the segment are the same.

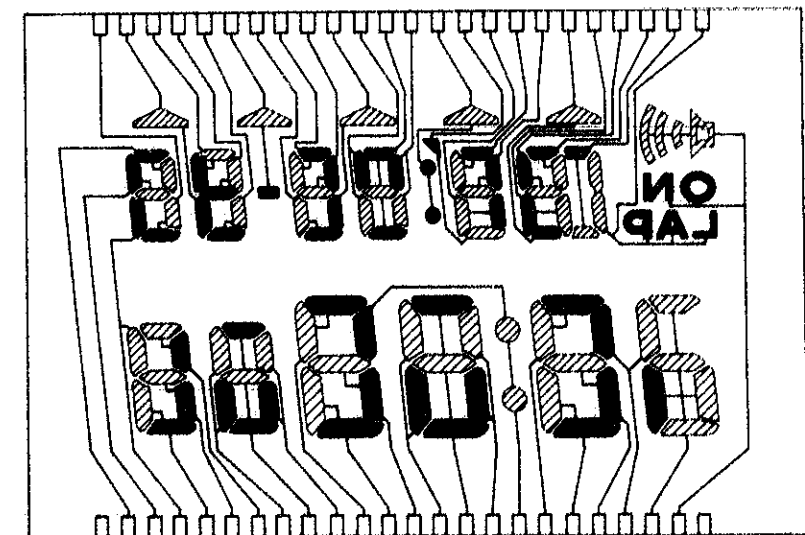

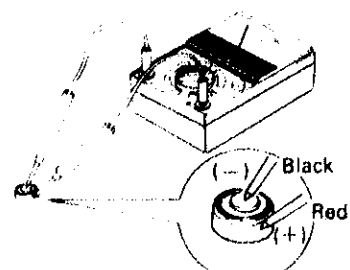
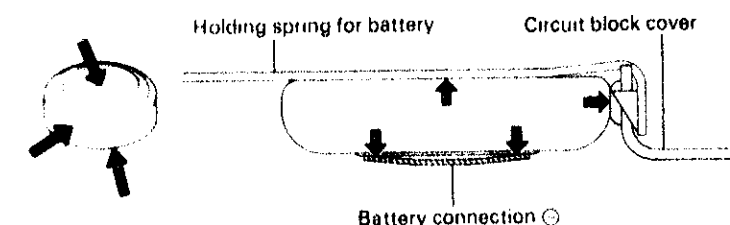

3. Procedure for checking and adjustment

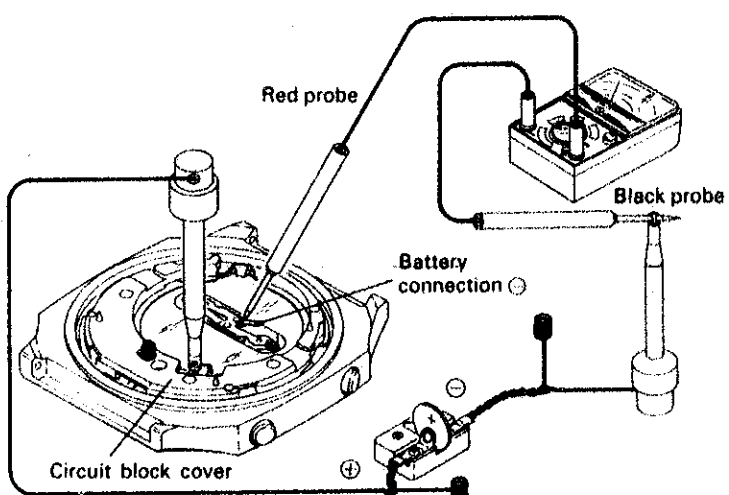
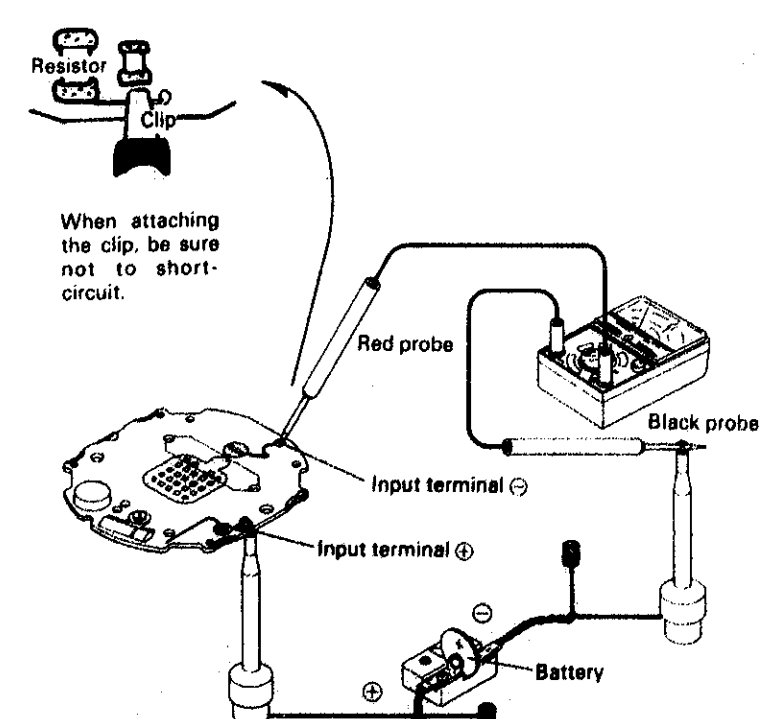
Procedure	Result and Repair
<p style="writing-mode: vertical-rl; transform: rotate(180deg);"><b>CHECK BATTERY VOLTAGE</b></p>  <p><b>NOTE:</b> If the battery is swelled up, the battery is defective. This may occur due to large current. Always replace the battery with new one. (Swelling: 0.2 ~ 0.3 mm)</p>	<p>More than 2.8V: Normal Less than 2.8V: Defective (Refer to NOTE 1 below.)</p> <p><b>NOTE 1:</b> The battery voltage temporarily drops when the light is illuminated, alarm is functioned or battery is short-circuited. When the battery voltage is 2.6 ~ 2.8V, keep the battery connected and leave the watch for a few minutes. If the battery voltage is still less than 2.8V, replace the battery with new one.</p>
<p style="writing-mode: vertical-rl; transform: rotate(180deg);"><b>CHECK BATTERY CONDUCTIVITY</b></p> <p>Check the battery, circuit block cover and battery connection ⊖ for contamination.</p>  <p><b>NOTE:</b> Take care not to deform the battery connection ⊖ and circuit block cover</p>	<p>Uncontaminated: Normal ... Proceed to [ ]</p> <p>Contaminated: Defective ... Clean.</p> <p>Poor water resistance is found: Correct water resistance.</p>

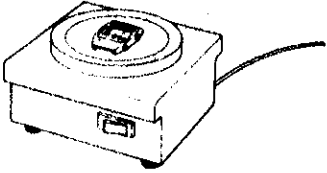
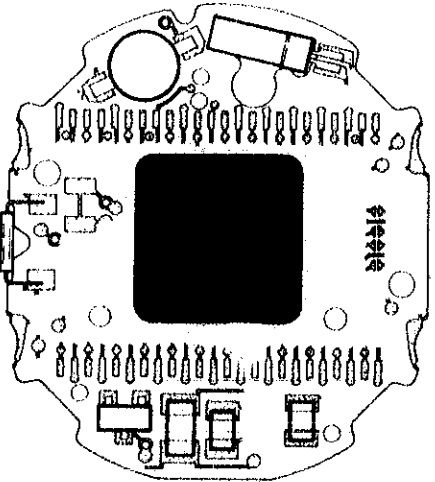
Procedure	Result and Repair
<p style="writing-mode: vertical-rl; transform: rotate(180deg);"><b>CHECK CURRENT CONSUMPTION</b></p> <p>(1) Total current consumption of module</p> 	<p>Less than 1.7 μA: Normal 1.7 μA or more: Defective Replace the circuit block or the liquid crystal panel.</p>
<p>(2) Current consumption of circuit block</p> <p>Reverse side</p>  <p>When attaching the clip, be sure not to short-circuit.</p>	<p>Less than 1.5 μA: Normal 1.5 μA or more: Defective Replace the circuit block</p>

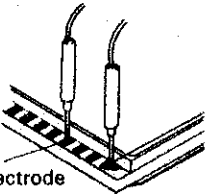
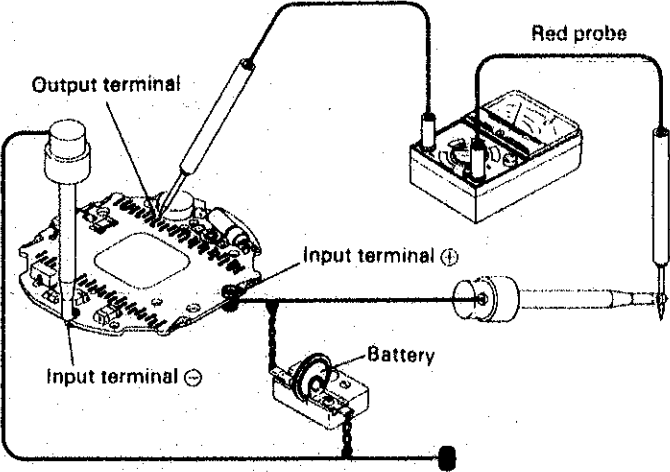
	Procedure	Result and Repair
CHECK WATER RESISTANCE	<p>Check for moisture in the watch.</p> <p>① Place the watch on a hot plate and heat for 15 minutes.</p>  <p>② Check that the glass does not collect moisture.</p>	<p>Does not collect moisture: Normal Proceed to <b>A</b>.</p> <p>Collects moisture: Defective Correct water resistance.</p>
CHECK CONTACT OF C-MOS-LSI ~ LIQUID CRYSTAL PANEL	<p>(1) Check for dust, lint and other contamination on the liquid crystal panel electrodes and connectors.</p> 	<p>Uncontaminated: Normal ... Proceed to <b>F</b>.</p> <p>Contaminated: Defective ... Wipe off any foreign matter.</p>
CHECK LIQUID CRYSTAL PANEL AND CIRCUIT BLOCK	<p>Check that the liquid crystal panel and circuit block function correctly. (Refer to "Relationship between the segments (liquid crystal panel electrodes) and C-MOS-LSI output terminals on page 6.)</p> <p>(1) Checking the liquid crystal panel</p> <p>① Set up the Volt-ohm-meter. Range to be used: OHMS <math>R \times 1 \sim R \times 1K</math></p> <div data-bbox="192 1833 854 2011" style="border: 1px solid black; padding: 5px;"> <p><b>NOTE:</b> Any range will do if more than 3V is applied to the terminal of the Volt-ohm-meter. In some testers, a voltage of more than 3V cannot be applied to the terminal. In this case, all segments are not displayed. Use a higher resistance range (<math>R \times 10k</math>).</p> </div>	

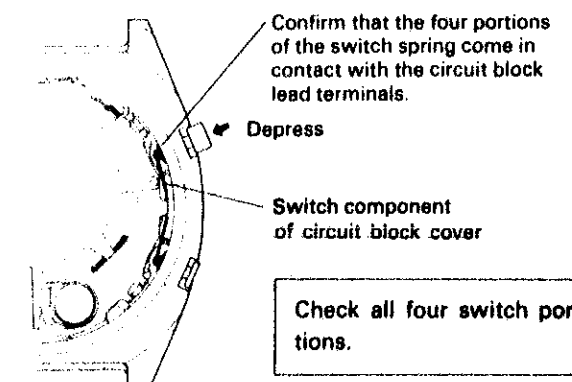
	Procedure	Result and Repair
CHECK LIQUID CRYSTAL PANEL AND CIRCUIT BLOCK	<p>② Remove the liquid crystal panel from the module and turn it to the reverse side.</p> <p>③ Check that the corresponding segment is displayed.</p>  <div data-bbox="2101 363 2389 485" style="border: 1px solid black; padding: 5px;"> <p><b>NOTE:</b> Either red or black probe will do.</p> </div> <p>Common electrode (Either red or black probe must be applied to the common electrode.)</p> <p>(2) Checking the circuit block output</p> <p>① Set up the Volt-ohm-meter. Range to be used: DC3V</p> <p>② Set up the circuit block.</p> <p>1) Disassemble the module and remove the circuit block.</p> <p>2) Supply power to the circuit block by connecting the power supplier as shown in the illustration.</p>  <p>③ Checking</p> <p>Red probe <math>\oplus</math>: Circuit block <math>\oplus</math> terminal Black probe <math>\ominus</math>: C-MOS-LSI output terminal (If a segment is defective, connect the black probe to the corresponding electrode.)</p>	<p>Displayed: Normal ... Proceed to <b>F</b>.</p> <p>Not displayed: Defective Replace the liquid crystal panel.</p> <p>More than 0.8V: Normal (The voltage at all terminals should be more than 0.8V.) Return to <b>E</b>.</p> <p>0.8V or less: Defective ... Replace the circuit block</p>
CHECK ACCURACY	<p>① Measuring mode Set the watch to the pattern segment mode.</p> <p>② Set the measuring gate of the Quartz tester to "10 second".</p> <p>③ Adjust the level.</p> <p>④ Measure the accuracy. The displayed value is the watch accuracy when the electronic regulation is 00.</p> <div data-bbox="1762 1711 2389 1833" style="border: 1px solid black; padding: 5px;"> <p><b>Note:</b> An unstable value may be displayed for 10 out of 120 seconds. Do not take this value into account.</p> </div> <p>⑤ Read the electronic regulation value. Set the watch for electronic regulation adjusting mode and read the value.</p>	<p>Functions correctly: Normal</p> <p>Does not function correctly: Defective → Time Adjustment Adjust the electronic regulation.</p>

	Procedure	Result and Repair
CHECK ACCURACY	<p>⑥ Calculate the accuracy of the watch.</p> <p>One step of the electronic regulation is 0.044 second/day. Multiply the electronic regulation value by 0.044 and add or subtract the result from the watch accuracy measured by the quartz tester. The result is the actual accuracy.</p> <p>&lt; Example of watch accuracy calculation &gt;</p> <p>Quartz tester reading: Electronic regulation value: Electronic regulation (1 step)</p> <p>A 0.09 second/day    B 02    C 0.044 second/day</p> <p><math>B \times C = 0.0088</math> second/day</p> <p><math>A + B \times C = 0.178</math> second/day</p> <p><b>Note:</b> Refer to the switching means for the electronic regulation adjusting mode on page 14.</p>	
CHECK FUNCTIONING	<p>Check the functioning referring to "Display function" on page 14.</p> <p>① Check that the time mode and calendar mode are changed correctly.</p> <p>② Check the functioning for each digit in the time and calendar modes and confirm that the digit is advanced correctly.</p>	<p>Functions correctly: Normal Wear the watch on the wrist to check time accuracy.</p> <p>Does not function correctly: Defective Replace the circuit block.</p>
CHECK THE CONDUCTIVITY OF SWITCH COMPONENT	<p>(1) Check that the switch spring functions correctly.</p>  <p>Confirm that the four portions of the switch spring come in contact with the circuit block lead terminals.</p> <p>Depress</p> <p>Switch component of circuit block cover</p> <p>Check all four switch portions.</p> <p>(2) Check for dust, lint and other contamination of the connecting portions.</p>	<p>Functions correctly: Normal</p> <p>Does not function correctly: Defective Correct the switch spring with tweezers or replace the switch spring with a new one.</p> <p>Uncontaminated: Normal</p> <p>Contaminated: Defective Wipe off any foreign matter.</p>
CHECK BULB CONDITION	<p>(1) Check that there is a blown filament in the bulb.</p> <p>① Set up the Volt-ohm-meter. Range to be used: OHMS R x 1.</p> <p>② Checking Apply two probes of the Volt-ohm-meter to the bulb leads as shown in the illustration.</p>  <p>Either red or black probe will do.</p>	<p>Bulb lights up: Normal</p> <p>Bulb does not light up: Defective Replace the bulb with a new one.</p>

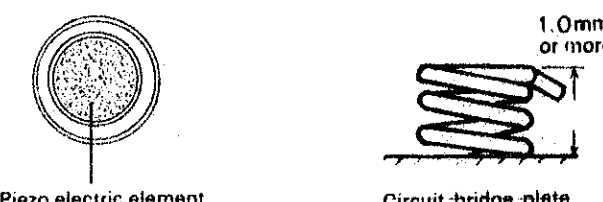
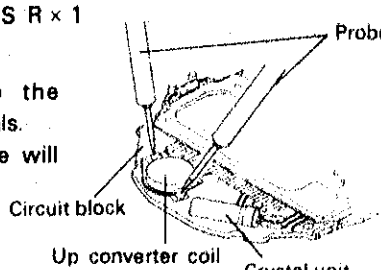
	Procedure	Result and Repair
CHECK ALARM FUNCTION	<p>(1) Check the contacting portion of the piezo electric element on the case back and buzzer lead terminal and check the buzzer lead terminal for deformation.</p>  <p>Piezo electric element    Circuit-bridge plate</p> <p><b>NOTE:</b> The buzzer lead terminal should be protruded from the circuit bridge plate by 1.0 mm or more. (Check when the buzzer lead terminal is completely installed.)</p> <p>(2) Measure the coil resistance of the circuit block booster to check for a short circuit and a broken wire. Range to be used: OHMS R x 1</p> <ul style="list-style-type: none"> <li>• Checking Attach the probes to the up converter coil terminals. Either red or black probe will do.</li> </ul>  <p>Probe Circuit block Up converter coil Crystal unit</p>	<p>Uncontaminated: Normal</p> <p>Contaminated: Defective Wipe off any foreign matter.</p> <p>Deformed: Defective Correct with tweezers.</p> <p>50Ω ~ 70Ω: Normal</p> <p>Less than 50Ω: Defective (Short circuit)</p> <p>More than 70Ω: Defective (Broken wire)</p> <p>Replace the circuit block with a new one.</p>
How to check for battery electrolyte leakage and repair	<p>(1) Remove the module from the case.</p> <p>(2) Disassemble the module.</p> <p>(3) Wipe off any electrolyte from the circuit block.</p> <ol style="list-style-type: none"> <li>1 Wipe off the electrolyte with cloth moistened with alcohol. (Pay particular attention to the connecting portion.)</li> <li>2 Dry with warm air by using a dryer.</li> </ol> <p><b>NOTE:</b></p> <ul style="list-style-type: none"> <li>• If the electrolyte leakage is excessive, replace the circuit block.</li> <li>• Use a lint-free cloth.</li> </ul> <p>(4) Clean other parts (circuit block cover, panel frame, battery connection ⊖ and reflecting mirror spacer) which become contaminated with the electrolyte.</p> <ol style="list-style-type: none"> <li>1 Wipe off battery electrolyte on the other parts with a soft brush moistened with alcohol.</li> <li>2 Dry with warm air by using a dryer.</li> </ol> <p><b>NOTE:</b></p> <ul style="list-style-type: none"> <li>• Do not clean the bulb which is installed in the reflecting mirror spacer.</li> <li>• If each part is damaged, replace it with a new one.</li> </ul> <p>(5) Reassemble the module. Replace the battery with a new one.</p> <p>(6) Check function and current consumption.</p>	



## V. DISPLAY FUNCTION

### < Time function >

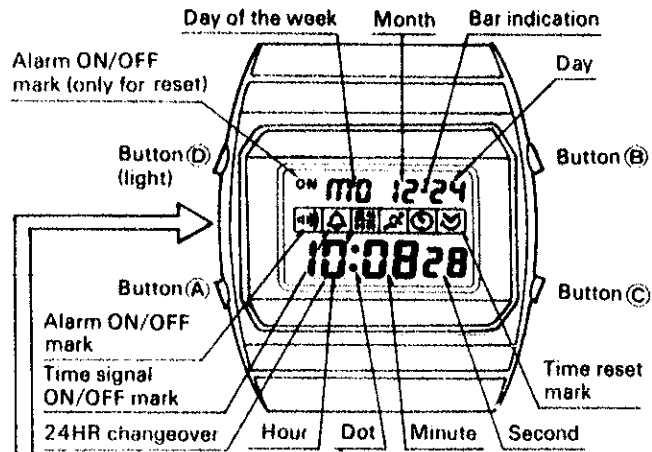

Keep on depressed for 1 ~ 2 seconds, the indication changes 12 or 24-hour system. When both buttons (B) and (C) are depressed simultaneously, the time signal turns ON/OFF.

Alarm reset time (Demand)

### < Alarm function >

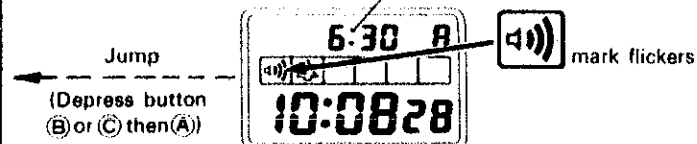

### < Stop watch function >

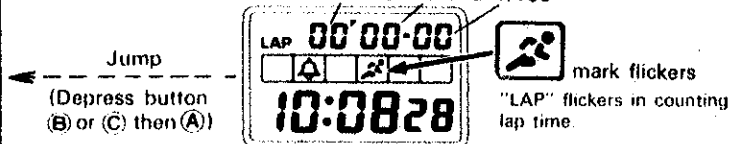

### < Interval timer mode >



### < time/calendar reset mode >

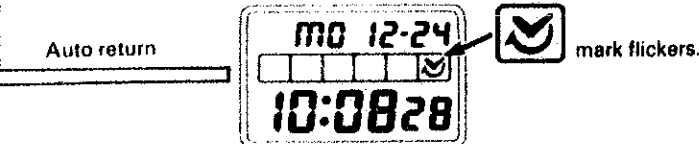

#### NOTE:

The illustrations shown in the left are for the pictogram type. In the case of indicator display type, each indicator flickers as follows.

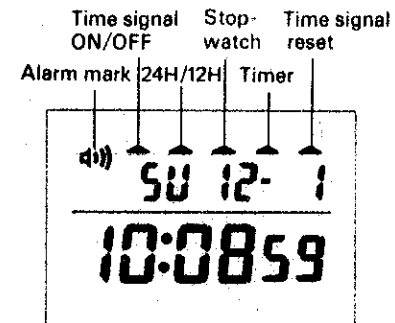

#### ● Electronic regulation adjusting mode

In the time and calendar setting mode, while depressing button (B), depress button (A) to set for "electronic regulation adjusting mode". In the electronic regulation adjusting mode, each depression of button (B) will adjust the time accuracy by approximately + 1.3 second/month. Each depression of button (C) will adjust it by approximately - 1.3 seconds/month.

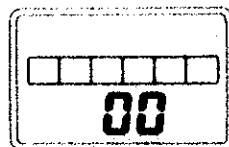

## PARTS LIST

## CAL. Y770A

PART NO.	PART NAME
4001 795	Circuit block
4216 795	Insulator for Circuit block
4225 790	Holding spring for battery
4246 795	Buzzer lead terminal
4270 795	Battery Connection ⊕
4313 795	Connector
4398 795	Liquid crystal panel frame
4410 795	Circuit bridge plate
4467 795	Circuit block cover
☆ 4510 . . .	Liquid crystal panel
4521 840	Reflecting mirror
4530 230	Bulb
MATSUSHITA BR2016	Lithium battery

☆ Liquid Crystal Panel . . . . . The liquid crystal panel to be used varies for the design of the models. At the time of ordering, please refer to the case number.