

TECHNICAL GUIDE

CAL. Y703 A

DIGITAL QUARTZ

CONTENTS

I. SPECIFICATIONS	1
II. DISASSEMBLING, REASSEMBLING, LUBRICATING AND CLEANING	2
1. Disassembling, reassembling and lubricating of the case	2
2. Disassembling and reassembling of the module	6
3. Cleaning	8
III. CHECKING AND ADJUSTMENT	9
1. Guide table for checking and adjustment	9
2. Relationship between the segment (Liquid Crystal Panel Electrode) and the C-MOS-LSI output terminal	10
3. Procedures for checking and adjustment	11
A. Check battery voltage	11
• How to check battery electrolyte leakage and repair	11
• Check pattern segment checking system	12
B. Check contact of C-MOS-LSI ~ liquid crystal panel	12
C. Check liquid crystal panel and circuit block	13
D. Check current consumption	14
E. Check accuracy	15
F. Check functioning and adjustment	15
G. Check speaker block	15
H. Check bulb condition	17
I. Check conductivity of switch components	18

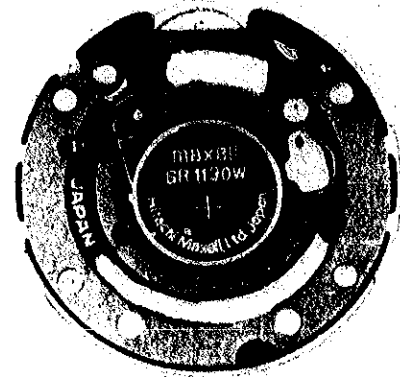
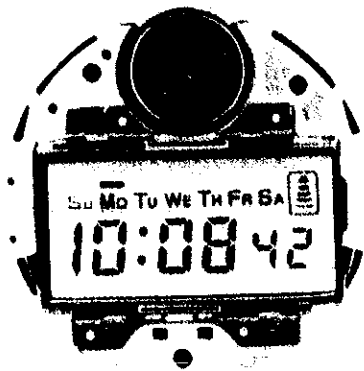

Module

I. SPECIFICATIONS

Item	Calibre No. Y703A
Display medium	Nematic Liquid Crystal, FEM (Field Effect Mode)
Display system	<p>Three-function changeover system with time, alarm setting and time/calendar setting functions.</p> <ul style="list-style-type: none"> Time function: Digital display system showing hour, minute, second and day of the week. In the time function, calendar and time set for the alarm are displayed by depressing a button. <ul style="list-style-type: none"> Calendar: Digital display showing month, date, day of the week and "A" (AM)/"P" (PM) Time set for the alarm: Digital display showing hour, minute and "A" (AM)/"P" (PM) Alarm setting function: Alarm time can be set to operate at the desired minute and 12 hour (with "A" (AM)/"P" (PM) indication) Time/calendar setting function: Setting of the second, minute, hour ("A" (AM)/"P" (PM)), date, month and day of the week
Additional mechanism	<ul style="list-style-type: none"> Alarm test system Time signal starts sounding every hour on the hour (When the minute digits and the second digits indicate "00".) Illuminating light Pattern segment checking system
Crystal oscillator	32,768 Hz (Hz = Hertz Cycle per second)
Loss/gain	<p>Loss/gain at normal temperature range</p> <p>Mean monthly rate : less than 15 seconds</p> <p>(Annual rate : less than 3 minutes)</p>
Casing diameter	φ30.1mm
Height	6.5mm (without battery)
Operational temperature range	-10°C ~ +60°C (14°F ~ 140°F)
Regulation system	Trimmer condenser
Battery power	<p>Silver oxide battery U.C.C. 389, Maxell SR1130W or Toshiba WG-10</p> <p>Battery life is approximately 2 years.</p> <p>Voltage: 1.55V</p>
IC (Integrated Circuit)	C-MOS-LSI 1 unit

II. DISASSEMBLING, REASSEMBLING, LUBRICATING AND CLEANING

1. Disassembling, reassembling and lubricating of the case

Disassembling procedures Figs.:

(1) ~ (6)

Reassembling procedures Figs.:

(6) ~ (1)

Lubricating:

Silicone grease 500,000 c.s.
Normal quantity

Glass and speaker portions

It is not necessary to disassemble the glass and the speaker cover except when they are required to be replaced. (Refer to pages 4 and 5 for handling them.)

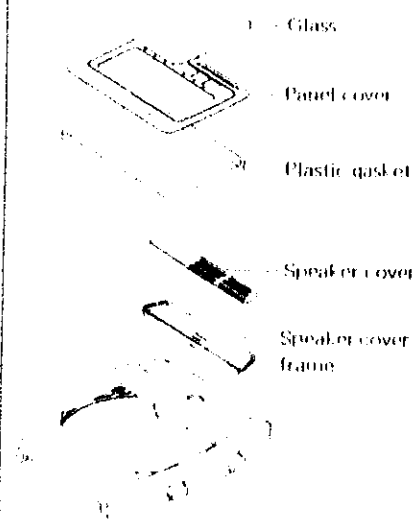

Ex) Y703-5009 [A]

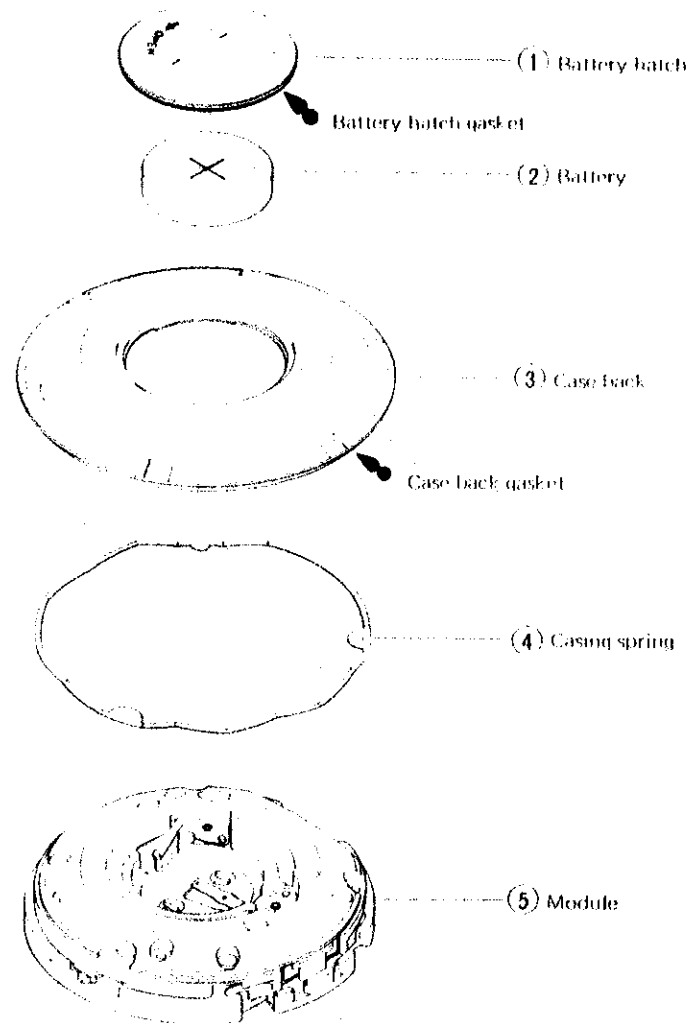

(Hook up for time adjusting button)
(Time adjusting button)

It is not necessary to disassemble the time adjusting buttons and hook-ups for time adjusting buttons (4 assemblies) except when they are required to be replaced.

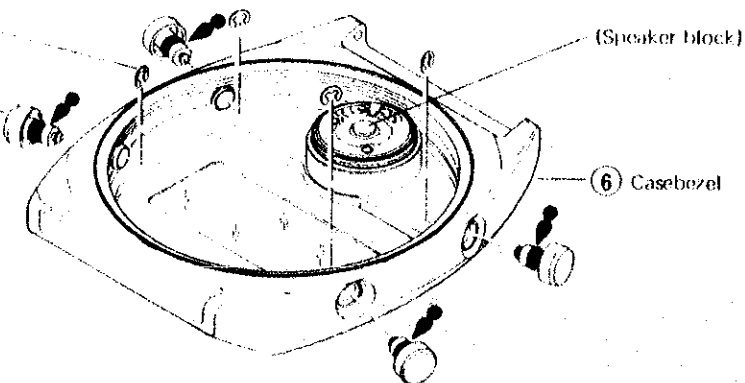

Remarks for disassembling

(5) Module

- The liquid crystal panel frame is fixed firmly to the case bezel. Pry up the module with tweezers to take out.
(Do not pry up at the speaker portion; the terminals of the speaker coil may be broken.)

(6) Case bezel

- The speaker block is set in the case bezel.
(Refer to page 7 for disassembling procedures.)

Remarks for reassembling

(6) Case bezel

- Before reassembling the module, pull out all buttons so that the switch springs do not prevent the module from being reassembled. (Push the buttons from inside with tweezers.)

(5) Module

- The liquid crystal panel frame is fixed firmly to the case bezel. Push in the module with fingers.
- Push it in so that it does not catch the buttons.

(4) Casing spring

- Set the casing spring.
Be careful not to mistake the upper side for the lower side.
(The casing spring has three protrusions, two of which are larger and one is smaller. Be sure to fit each of them to the corresponding notches of the module.)

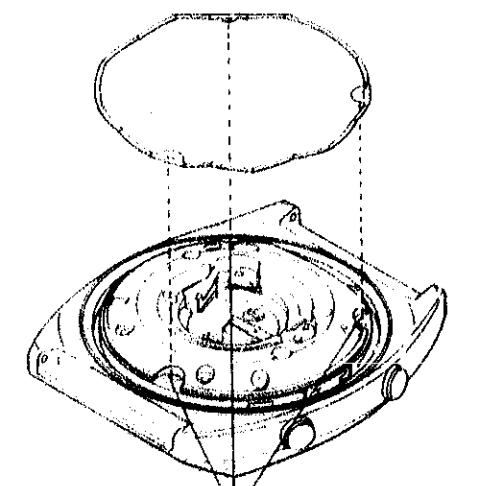
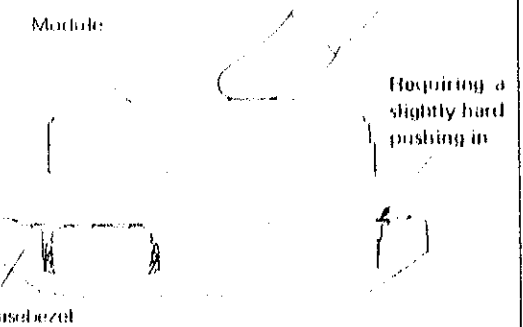
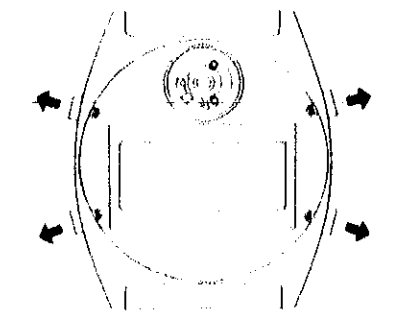
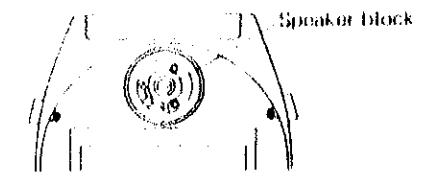
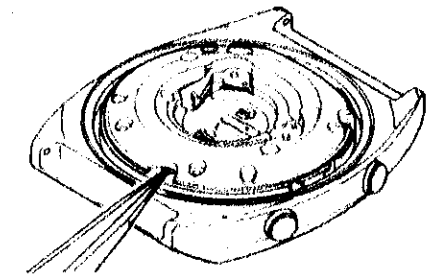

How to replace the glass

(Do not disassemble the glass and the panel cover except when they are required to be replaced.)

• Disassembling of the glass

- Use the tightening tool S-220 to disassemble the glass.
Inserting disk: S-161
Supporting disk: $\phi 33.0 \sim \phi 34.0$
- Place a vinyl sheet between the glass and the supporting disk as shown in the illustration on the right.
- Push the panel cover and glass together to remove.

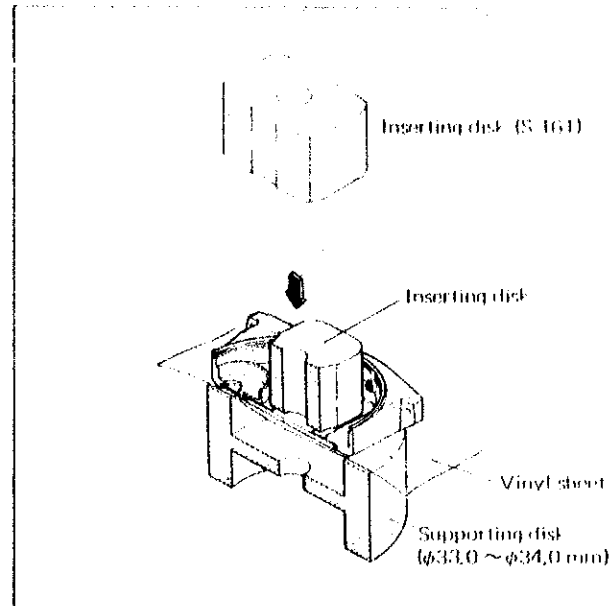

• Reassembling of the glass

- Set the plastic gasket.
 - Be sure to replace the plastic gasket with a new one.
 - Be careful not to mistake the upper side for the lower side.
- Reassemble the panel cover.
 - Be sure to set the lower side of the panel cover fast to the casebezel.
 - Be sure that the space between the casebezel and the edge of the panel cover is uniform in width.
- Place the glass.
 - Be careful not to mistake the upper side for the lower side. Place the round side down.
- Push in the glass (by using S-220)
Inserting disk: Plastic supporting disk (S-173)
Supporting disk: $\phi 28.0\text{mm}$ or $\phi 28.5\text{mm}$

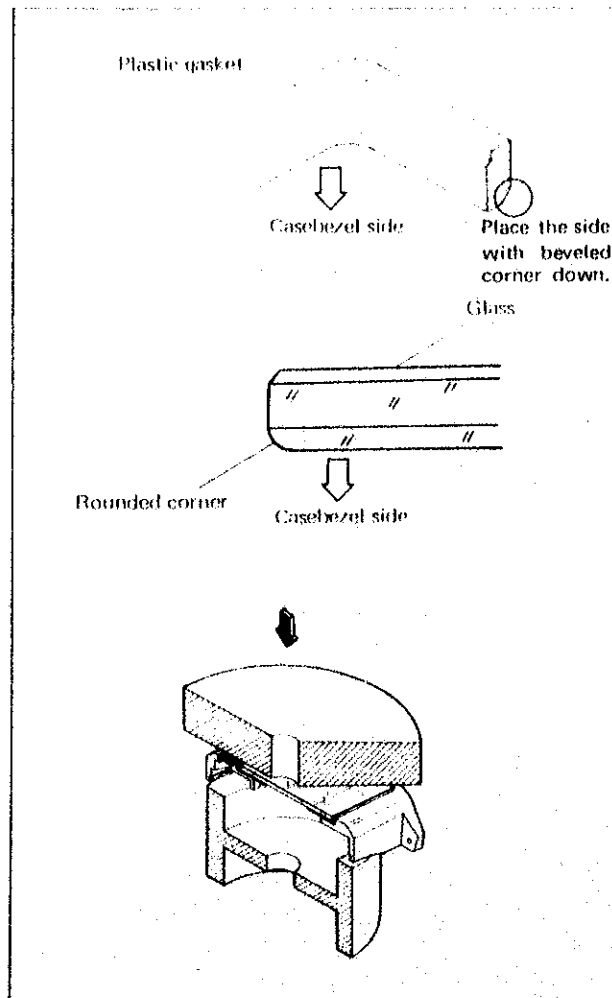

How to replace the speaker cover

The speaker cover and the speaker cover frame are set to the casebezel. It is not necessary to disassemble the speaker cover and the speaker cover frame except when they are required to be replaced.

• Removing of the speaker cover

- Disassemble the speaker.
(See page 7 for the disassembling procedures of the speaker.)
- Remove the speaker cover by pushing it through the speaker hole inside the casebezel. The speaker cover and the speaker cover frame are removed together. (Fig. 1)
- Remove the speaker cover as shown in Fig. 2. Remove the speaker cover in the order of (1), (2), (3).

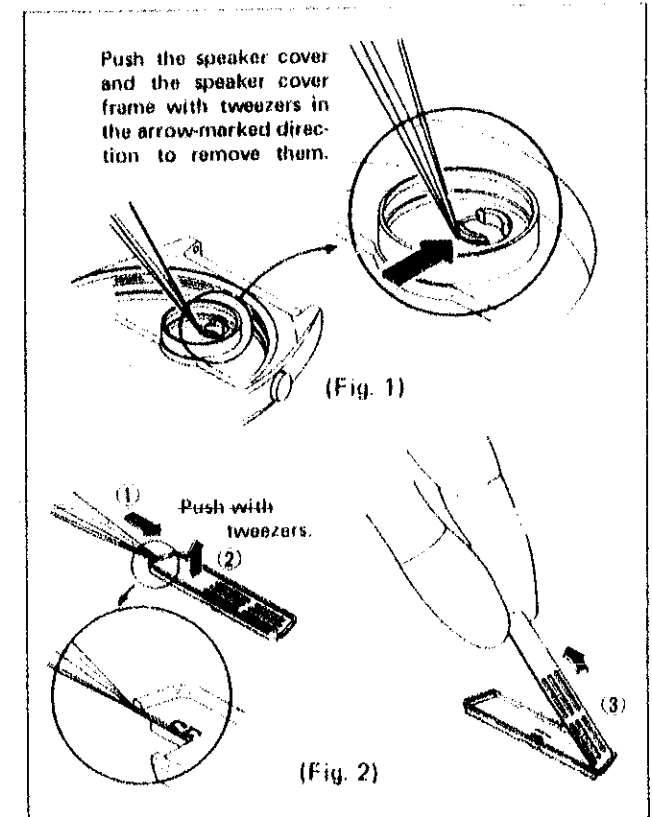

• Reassembling of the speaker cover

- Set the speaker cover in the speaker cover frame. Reassemble the speaker cover and the speaker cover frame in reverse order to the disassembling procedures. (Fig. 3)
The speaker cover frame can be reused, if not damaged.
- Set the speaker cover and the speaker cover frame together to the casebezel. Fit the leg portion of the speaker cover to the speaker hole portion of the casebezel and push it in. (Fig. 4)
If the speaker cover cannot be pushed in with fingers, place a vinyl sheet on it so as not to scratch and push it hard with the flat part of the end of the tweezers.

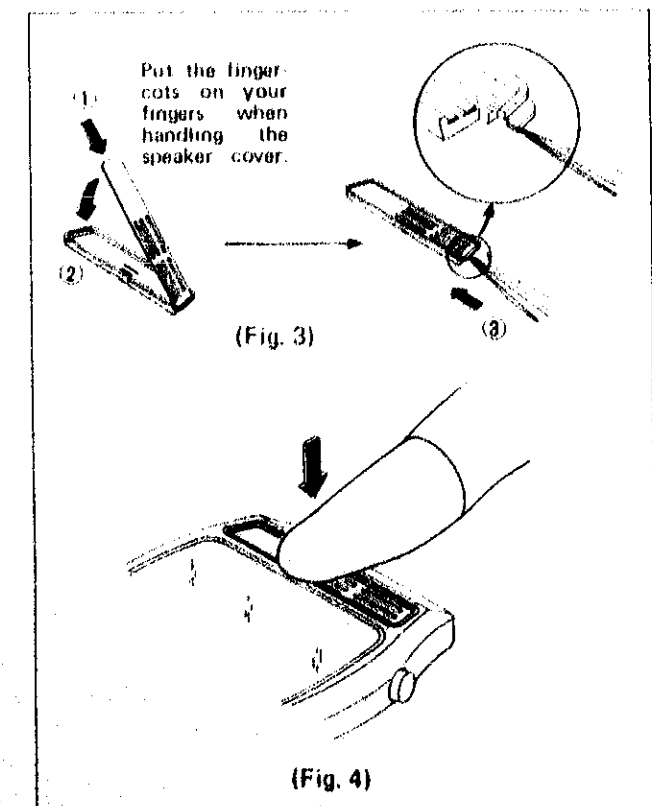

2. Disassembling and reassembling of the module

Disassembling procedures Figs.: (1) ~ (9)

Reassembling procedures Figs.: (9) ~ (1)



- (1) Speaker block
It is not necessary to remove the speaker block except when it is required to be replaced.
- (2) Liquid crystal panel holder screw (4 pcs.)
- (3) Liquid crystal panel holder
- (4) Liquid crystal panel
- (5) Reflecting mirror
- (6) Connector
- (7) Liquid crystal panel frame (with bulb)
- (8) Switch spring
- (9) Circuit block

Remarks for disassembling

- (1) **Speaker block**
 - Hold the speaker block at its groove by the tips of the tweezers and pull out the speaker block from case bezel as shown in the illustration.
 - Or pry up the speaker block by pushing up on its outer edge evenly with a tip of a screwdriver.

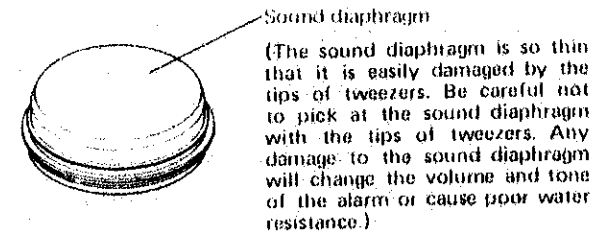

- When the speaker gasket is replaced, be careful not to mistake the upper side for the lower side. (Reassemble the speaker gasket with its round side turned up. Otherwise, the speaker gasket may be twisted.)

- (5) **Reflecting mirror**
 - Be careful not to scratch or contaminate the reflecting mirror.
- (6) **Connector**
 - The connectors may be disassembled together with liquid crystal panel.
 - Be careful not to scratch the connectors with tweezers.
 - There is no difference between the connectors in the top and bottom.
- (9) **Circuit block**
 - Be careful not to touch the electronic parts except when it is required.

Remarks for reassembling

- (8) **Switch spring**
 - Set the switch spring in position vertically from above.
 - Push it in by the flat part of the end of the tweezers.

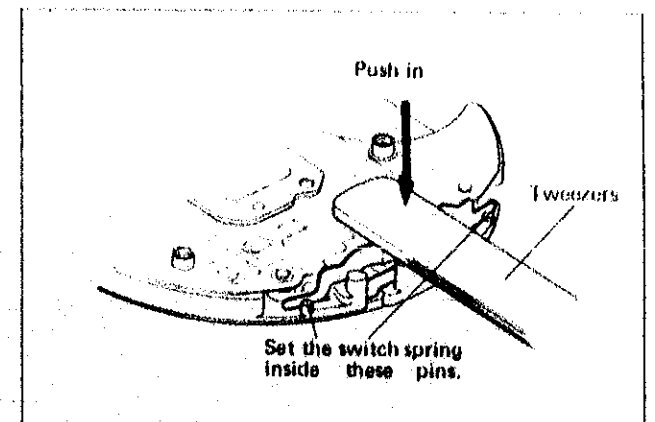
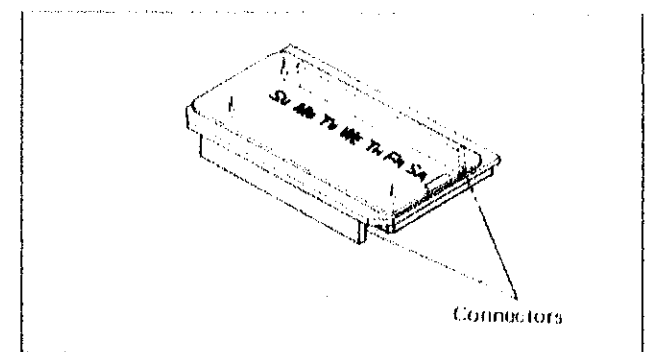
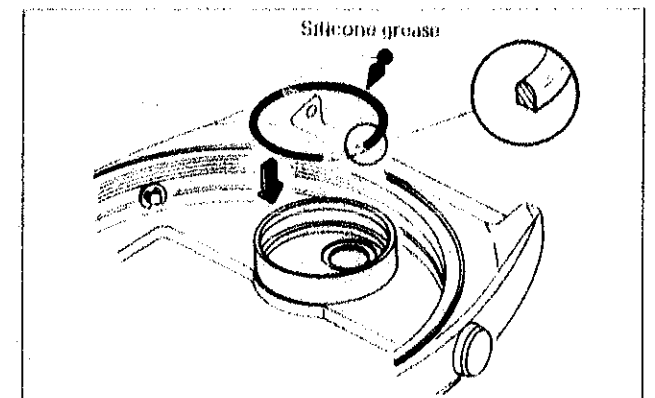
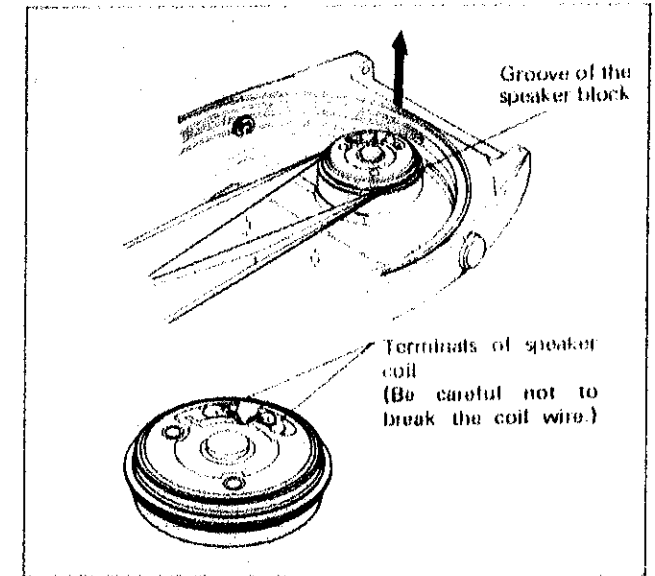

3. Cleaning

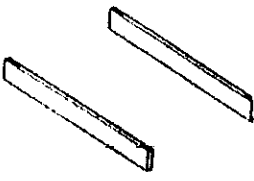
Name of parts	Cleaning	Drying	Solution	Remarks
Connector 	Rinse	Hot air	Alcohol or	<ul style="list-style-type: none"> • Be sure to reassemble after drying thoroughly. • Do not use benzine or trichloroethylene as they expand the connector.
Other parts Switch spring, liquid crystal panel holder and liquid crystal panel holder screw.	Clean or rinse with a cleaner or a brush.	Cool or hot air	Trichloroethylene, benzine, alcohol or	

* PARTS THAT MUST NOT BE CLEANED

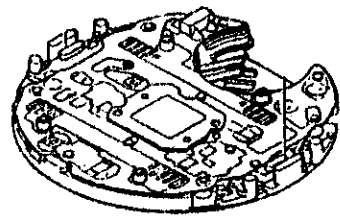

Circuit block



Liquid crystal panel

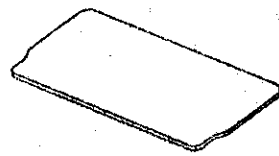

Reflecting mirror

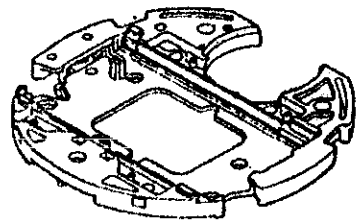

Liquid crystal panel frame (with bulb)



Speaker block

- Wipe dust and lint off with a soft brush.
- Be sure to clean only stains on the electrodes of the liquid crystal panel, the circuit block and the metal diaphragm of the speaker block with a cloth moistened with benzine, alcohol or DAIFLON SOLVENT S-3.

III. CHECKING AND ADJUSTMENT

Be sure to use the Static electricity protector (S-830) when handling the module.

1. Guide table for checking and adjustment

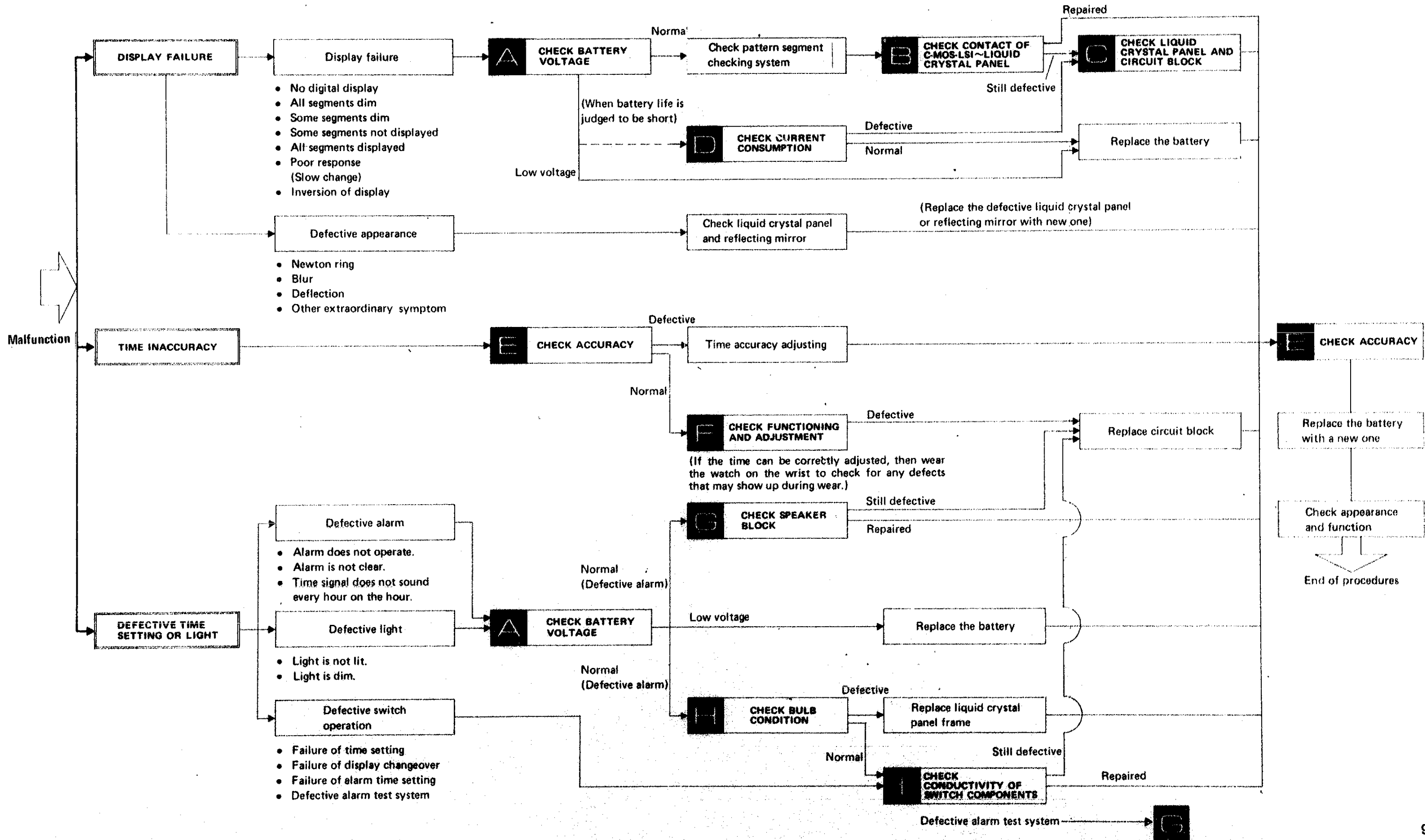

2. Relationship between the segment (Liquid Crystal Panel Electrode) and the C-MOS-LSI output terminal

A complete knowledge of how the segment (Liquid Crystal Panel Electrode) works with the C-MOS-LSI output terminal will provide the proper procedures for checking and adjustment.

• Designation of segment

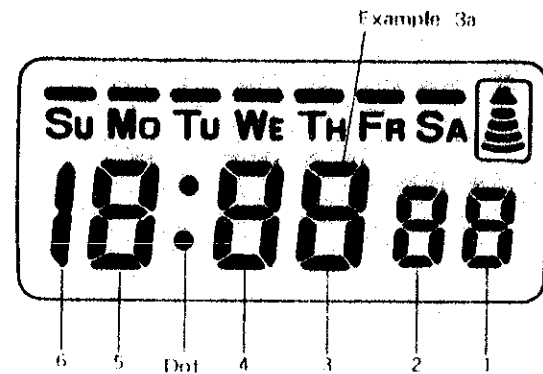
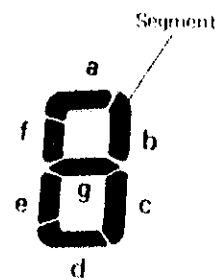

• Relationship between the segment and the C-MOS-LSI output terminal

The liquid crystal panel electrode is connected electrically with each segment which forms a digital figure as shown in the illustration of the panel pattern below. (The panel pattern can be seen if the panel is slightly tilted and looked at in an angular position.)

Also, the liquid crystal panel electrode is connected electrically with the C-MOS-LSI output terminal by the connector.

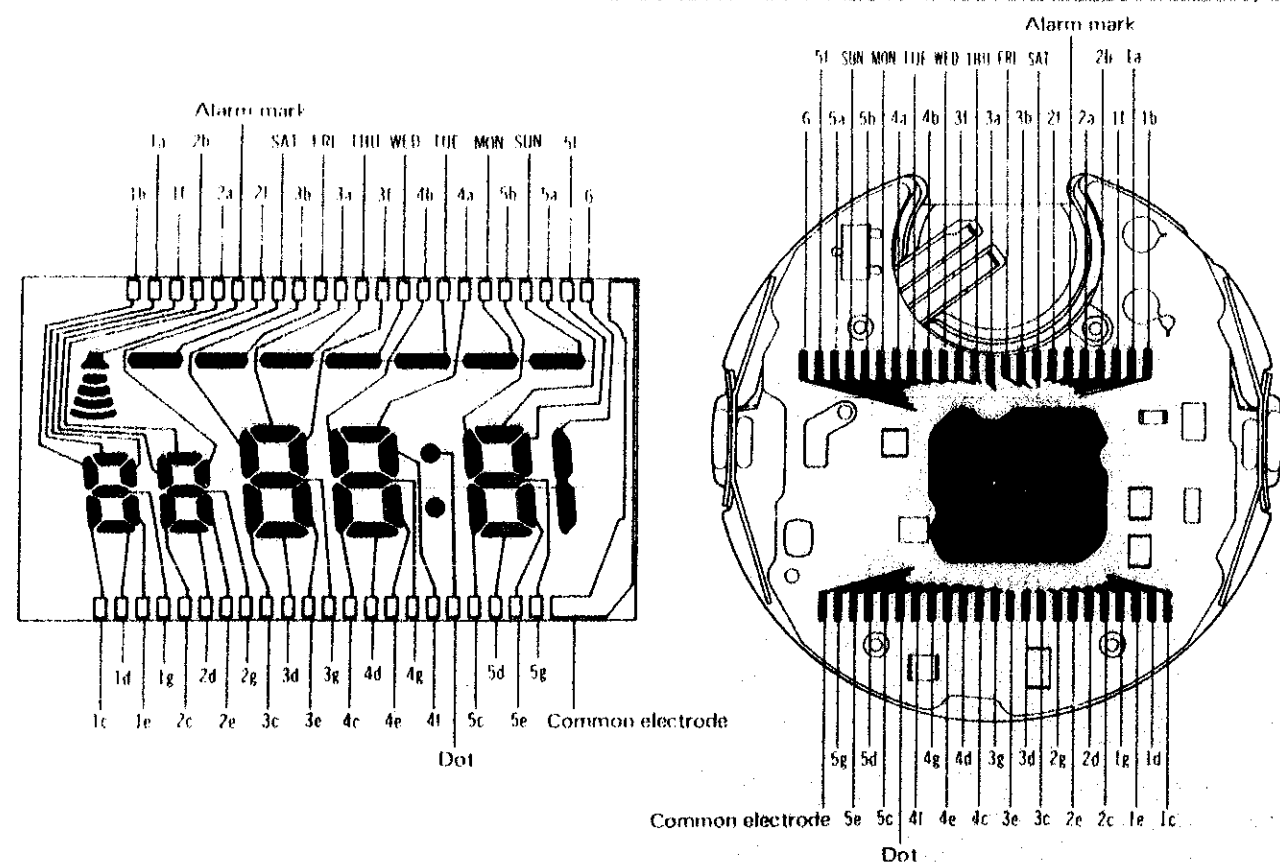

Note: Poor conductivity of the common electrode causes the lighting of all segments or inversion of the display.

3. Procedures for checking and adjustment



CHECK BATTERY VOLTAGE

Procedure

Use the following procedures to check battery voltage.

When there is battery electrolyte leakage, refer to "HOW TO CHECK BATTERY ELECTROLYTE LEAKAGE AND REPAIR" below for repairing.

Result and repair

More than 1.5V ... Normal
Less than 1.5V ... Defective

- (1) Remove the module from the case.
- (2) Disassemble the module.
- (3) Wipe off battery electrolyte on the circuit block.

1. Wipe off battery electrolyte with a cloth moistened with distilled water. If distilled water is not available, use normal tap water.

Note:

- Do not expose the trimmer condenser to water or alcohol, and if it is exposed, there may be a change in its capacity and eventually in the time accuracy.
- Do not use a cloth which gives off lint such as gauze, flannel, etc.

When the circuit block is cleaned, be sure to clean the connecting portions.

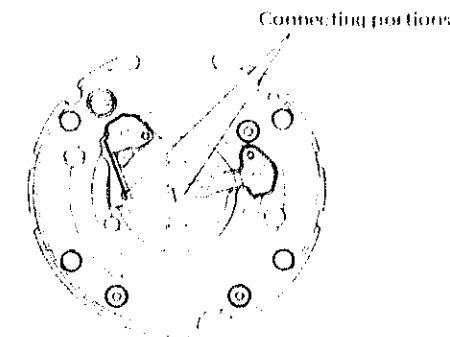

If the circuit block is badly contaminated with battery electrolyte, replace the circuit block with a new one.

- When the circuit block is rusted.
- When the liquid crystal panel side is contaminated with battery electrolyte.

2. Rinse with alcohol.
(If the cleaned portions remain wet with water, they will corrode with rust.)
3. Dry with warm air by using a dryer.
- (4) Clean the other parts. (Switch spring, etc.)
 1. Wipe off battery electrolyte on the other parts with a soft brush moistened with distilled water.
(If distilled water is not available, use tap water.)
 2. Rinse with alcohol.
 3. Dry with warm air by using a dryer.
- (5) Reassemble the module.
Replace the battery with a new one.
- (6) Check to see if the time and calendar functions and the current consumption are normal.

HOW TO CHECK BATTERY ELECTROLYTE LEAKAGE AND REPAIR



Procedure

If some segments are dead or dim, set the mode for the time and calendar setting functions. Then depress two buttons on the right side together to find the defective segment.

(If there is no defective segment, all segments light up.)

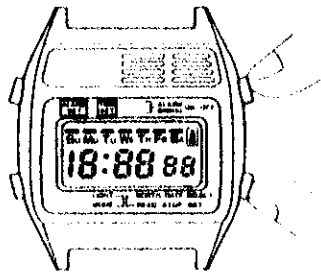

After removing the liquid crystal panel, check for poor conductivity of the liquid crystal panel, connector and C-MOS-LSI output terminal whose segments are found to be defective in "CHECK PATTERN SEGMENT CHECKING SYSTEM".

(Refer to "Relationship between the segment and C-MOS-LSI output terminal" on page 10.) Use a microscope for checking.

- (1) Check for dust, lint and other contamination on the liquid crystal panel electrode.

Liquid crystal panel electrode

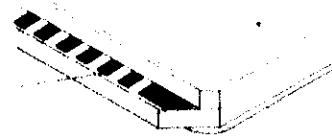

- (2) Check for any contamination, scratch, crack and break of the connector.

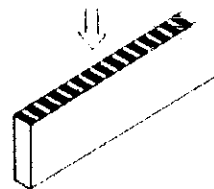

Be sure to check the connecting portion of the liquid crystal panel and the circuit block carefully.

- (3) Check for dust, lint and other contamination on the output terminal of the circuit block.



Output terminal of the circuit block

Result and repair

Proceed to (1).

Uncontaminated: Normal
Proceed to (2).

Contaminated: Defective
Wipe off any foreign matter.

No contamination, scratch, crack or break: Normal
Proceed to (3).

Contaminated: Defective
Clean.

Scratched, cracked or broken: Defective
Replace the connector with a new one.

Uncontaminated: Normal
Proceed to (1).

Contaminated: Defective
Wipe off any foreign matter.

Procedure

Check to see if the liquid crystal panel and the circuit block function correctly.

(Refer to "Relationship between the segment and the C-MOS-LSI output terminal" on page 10.)

- (1) Check liquid crystal panel.

1. Set up the volt-ohm-meter.

Range to be used: OHMS R x 1 ~ R x 1K

Note:

- Any range will do if more than 3V is applied to the terminal of the Volt-ohm-meter.
- When the Volt-ohm-meter other than Volt-ohm-meter S-831 is used, all segments may not be lit. If any segment does not light, change the range to the one (R x 10K) which is higher in resistance than R x 1K.

2. Remove the liquid crystal panel from the module and turn it upside down.
3. Measuring (Check to see if the corresponding segment lights up.)

Note: Either red or black probe will do.

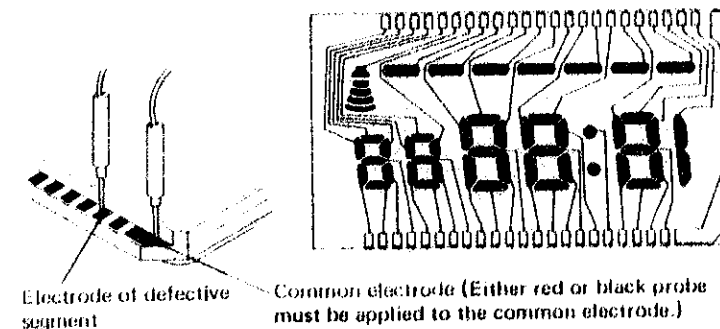

- (2) Check the circuit block output voltage.

1. Set up the volt-ohm-meter.

Range to be used: DC 3V

2. Attach the electricity supplier (S-833) to the circuit block.

Spring (+): Plus terminal of battery connection

Spring (-): Battery connection

3. Measuring

Probe Red (+):

Pin for the liquid crystal panel holder screw of the circuit block

(Shown in the illustration)

Probe Black (-):

Each portion of the output terminals of the C-MOS-LSI.

(If some displays are defective, apply to the corresponding output terminals of the C-MOS-LSI.)

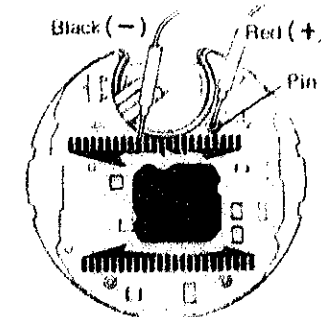
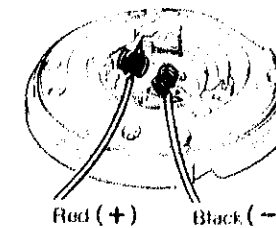

Result and repair

Lights up: Normal
Proceed to (2).

Does not light up: Defective
Replace the liquid crystal panel with a new one.

More than 0.8V: Normal
Return to (1).

Less than 0.8V: Defective
Replace the circuit block with a new one.

Procedure

Check to see if the current consumption is normal.
(Can be checked no matter which function the watch may be performing.)

- Volt-ohm meter

Range to be used: DC $12\mu\text{A}$ or 0.03mA *

Use the electricity supplier (S833) and connect as shown in the illustration below.

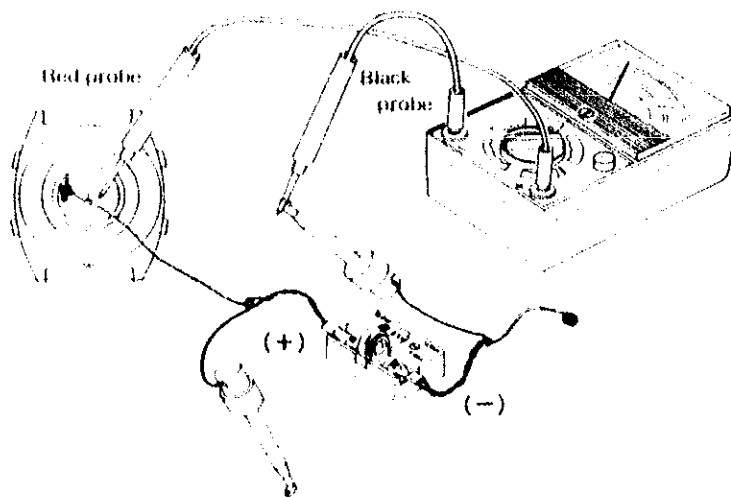

- Micro Test

Set up the Micro Test.

- | | |
|---|------------------------------------|
| (1) Power switch | : ON |
| (2) Polarity changeover button | : + |
| (3) Current consumption/
Voltage indication button | : μA |
| (4) Voltage selection button | : 1.55V |
| Probe Black (+) | : Battery connection |
| Clip Red (-) | : Button (except the light button) |

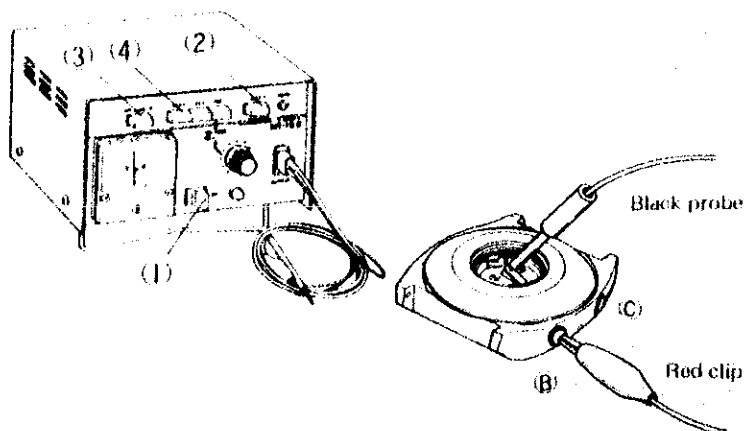

Apply the red clip (+) to the button "B" or "C" for measuring. Be careful not to depress the button while measuring.

Result and repair

* Note:

If the pointer of the volt-ohm-meter swings over the maximum value when DC $12\mu\text{A}$ or 0.03mA is used, change the range to a greater one where the pointer does not run over the maximum value while applying the probes to the respective portions. Then, after two or three seconds, return the range to DC $12\mu\text{A}$ or 0.03mA again for measuring.

Less than $3.0\mu\text{A}$: Normal

Replace the battery with a new one.

More than $3.0\mu\text{A}$: Defective

Proceed to .

Remarks:

If the pointer of the Micro Test swings over the maximum value while the current consumption is measured, depress the Current consumption/Voltage indication button (3) so that it is released to indicate the voltage (1.55V) while the black probe and the red clip are applied. Then, after two or three seconds, depress the Current consumption/Voltage indication button again so that it holds in the pushed-in position (μA) to indicate the current consumption for measuring.

Procedure

Check gain and loss of time.

- (1) Set up the Quartz Tester.
- (2) Measuring.

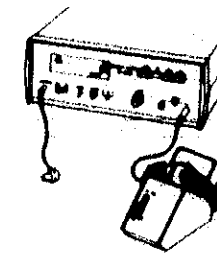

Check functioning and adjustment by operating the buttons.

- (1) Check the alarm time setting function.
Set the hour and minute more than one cycle and check to see if the digits are advancing correctly.
- (2) Check the time and calendar setting function.
Set the time and calendar digits more than one cycle for each unit and check to see if each digit is advancing correctly.

- (1) Check to see if the speaker sounds the alarm correctly.
Check to see if the speaker sounds when the watch is in the time function and when the two buttons on the right side are depressed together.



The alarm time is displayed.

Result and repair

Normal:

Proceed to next.

If the watch tends to gain or lose, proceed to **Time accuracy adjusting**.

Time accuracy is adjusted by turning the trimmer condenser.

Functions correctly and can be adjusted: Normal

Wear the watch on the wrist to check time accuracy.

Does not function correctly or cannot be adjusted: Defective

Replace the circuit block.

Speaker sounds: Normal

Set the alarm time and if the alarm does not operate at the required time, proceed to **Replace the circuit block**.

Speaker does not sound or it sounds but not clear: Defective

Proceed to  (2).

G**Procedure**

- (2) Check for any dust and scratches on the sound diaphragm of the speaker block.

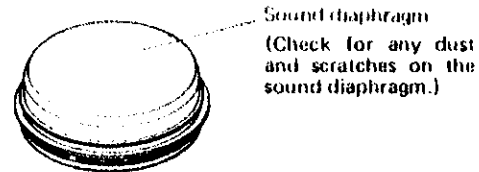

Note: Make sure that the speaker hole isn't clogged with dust.

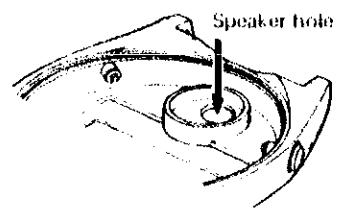

- (3) Check for any broken coil wire and short-circuit of the coil of the speaker block.

1. Set up the volt-ohm meter.
Range to be used: OHMS R x 1
2. Measuring

Apply the probes of the Volt-ohm-meter to the lead terminal of the speaker block.

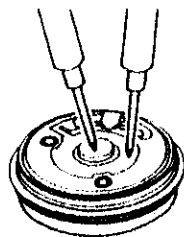

Note: Be careful not to break the coil wire when the probes are applied to the coil terminal.

- (4) Check to see if the output signal of the circuit block is transmitted to operate the speaker block.

1. Set up the Volt-ohm-meter.
Range to be used: DC 3V
2. Supply voltage power to the module.
 - Attach the electricity supplier (S-833) to the module as shown in the illustration.
 - Make the alarm ready for sounding by adjusting the switch spring.
3. Measuring

Apply the probes of the Volt-ohm-meter to the output terminals for speaker of the circuit block as shown in the illustration on the right. Check to see if the pointer of the Volt-ohm-meter swings twice every second.

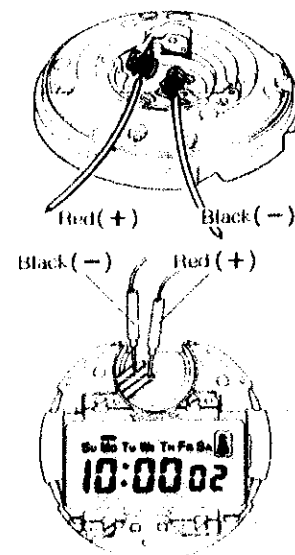
**Result and repair**

No dust or scratches: Normal
Proceed to **G** (3).

Dust: Defective
Wipe off any foreign matter softly with a cloth moistened with cleaning solution.

Scratched: Defective
Replace the speaker block.

Resistance $30\Omega \sim 150\Omega$: Normal
Proceed to **G** (4).

Less than 30Ω or more than 150Ω : Defective
Replace the speaker block.

Pointer swings twice every second: Normal
Replace the speaker block.

Pointer does not swing twice every second: Defective
Replace the circuit block.

CHECK SPEAKER BLOCK**H****Procedure**

- (1) Check to see if the bulb lead terminals touch the lead terminal of the circuit block.

1. Check to see if the two bulb lead terminals protrude by more than 0.3mm from the back side of the panel frame. And check for any dust, lint and other contamination of the bulb lead terminal. Protrusion "h" of the bulb lead terminal should be two-thirds or more of the thickness "a" of the panel frame.

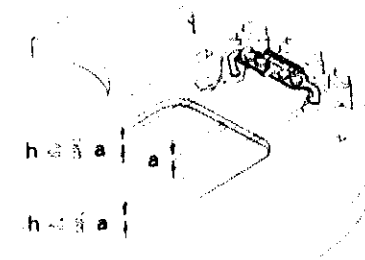

2. Check for any contamination on the bulb lead terminal of the circuit block.

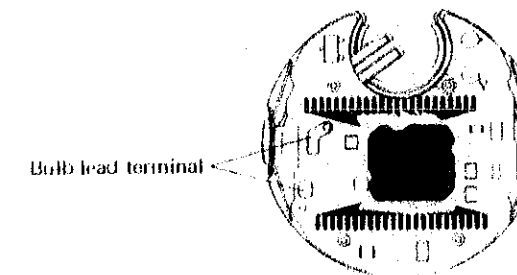
**CHECK BULB CONDITION**

- (2) Check to see if there is a broken filament in the bulb and if there is any break in the welded portion of the bulb lead terminal.

1. Set up the Volt-ohm-meter.
Range to be used: OHMS R x 1
2. Measuring

Apply the two probes of the Volt-ohm-meter to the bulb lead terminal as shown in the illustration.

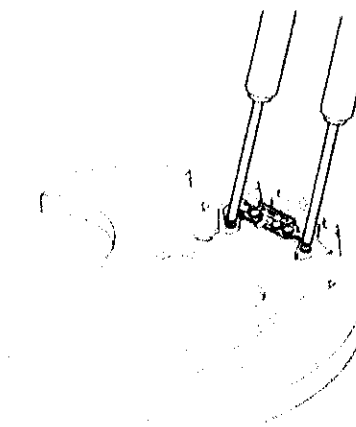

Note: Either red or black probe will do.

Result and repair

Protrudes by more than 0.3mm: Normal

Protrudes by less than 0.3mm: Defective
Pull out by using tweezers.

No dust, lint or uncleaned: Normal
Proceed to **H** (2).

Dust, lint or contaminated: Defective
Wipe off any foreign matter.

Bulb lights up: Normal
Proceed to **H**.

Bulb does not light up: Defective
Replace the liquid crystal panel frame.

