

TECHNICAL GUIDE

AND PARTS LIST

CAL. V602A

ANALOGUE QUARTZ

CONTENTS

I. SPECIFICATIONS	1
II. LIST OF SCREWS USED.....	1
III. OPERATION	2
IV. DISASSEMBLING, REASSEMBLING AND LUBRICATING	3 ~ 4
V. CHECKING AND ADJUSTMENT	5 ~ 8
VI. PARTS LIST.....	9

I. SPECIFICATIONS

Item		Cal. No.	V602A
Time indication		Three hands (hour, minute, second) + Multi function hand	
Driving system		Step motor 3 pcs. (Fixed pulse system)	
Display system		<ul style="list-style-type: none"> ● Hands adjust display ● World time display ● Dual time display ● Time with alarm on display ● Time with alarm off display ● Alarm display 	
Loss/gain		Monthly rate: Less than 20 seconds at normal temperature range	
Movement size	Casing diameter	φ29.1 mm	
	Height	3.8 mm (with battery clamp)	
Regulation system		Trimmer condenser	
Quartz Tester measuring gate		Any gate is available	
Battery		SEIKO SR1130W, MAXELL SR1130W, SONY EVEREADY 389, U.C.C. 389 Voltage: 1.55V Battery life: Approx. 2 years	
Jewels		0 jewel	

II. LIST OF SCREWS USED

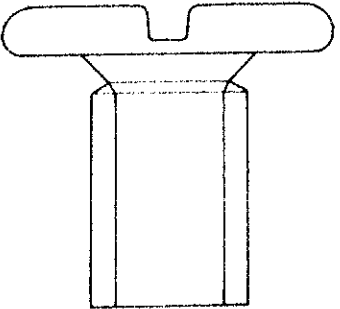
 <p>012 201</p>	Battery clamp screw (1 pce.) Switch spring screw (4 pcs.) Coil block screw (3 pcs.) Circuit block screw (1 pce.) Screw for additional train wheel bridge (2 pcs.) Train wheel bridge screw (2 pcs.) Center wheel bridge screw (1 pce.)
--	--

III. OPERATION

1. MODE AND BUTTON OPERATION

(To select mode, turn rotating bezel and set desired mode at the 12 o'clock position.)

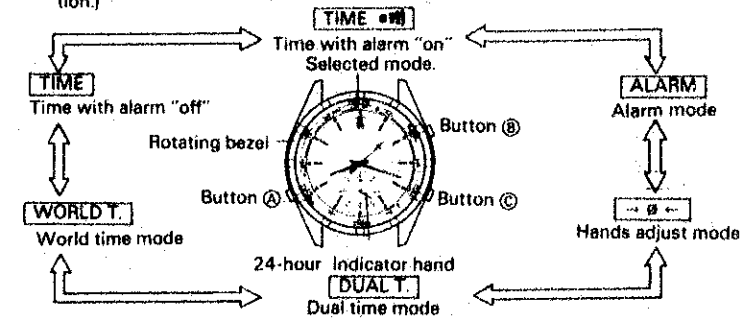

NOTE:
WHEN THE MODE IS CHANGED, ALL FOUR HANDS MOVE TO INDICATE THE SELECTED MODE TIME.

2. NECESSARY STEPS AFTER BATTERY REPLACEMENT

After replacing the battery, there will be a discrepancy between the information stored in the integrated circuit (IC) within the watch, and the position the hands indicate. Be sure to close the caseback and follow right [1] to [3] steps to adjust:

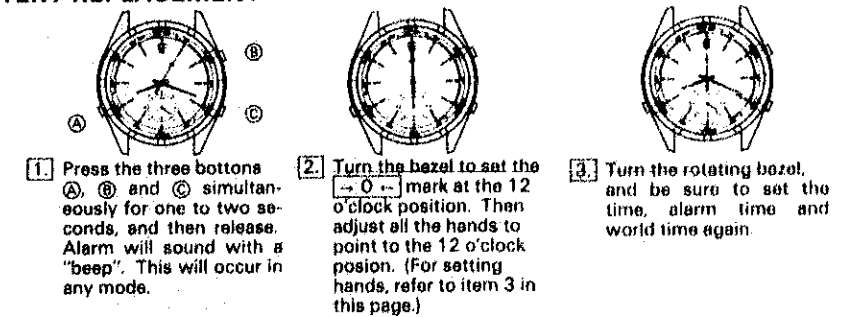

3. HOW TO CHECK AND ADJUST FOR HANDS POSITION

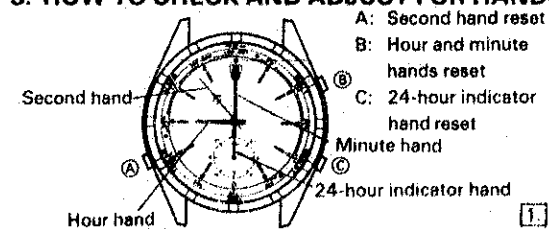

Before setting to other mode, turn the rotating bezel and set 0 mark at the 12 o'clock position. Minute, second, and 24-hour indicator hands should point to the 12 o'clock position as above. If not, follow right [1] to [4] steps to adjust:

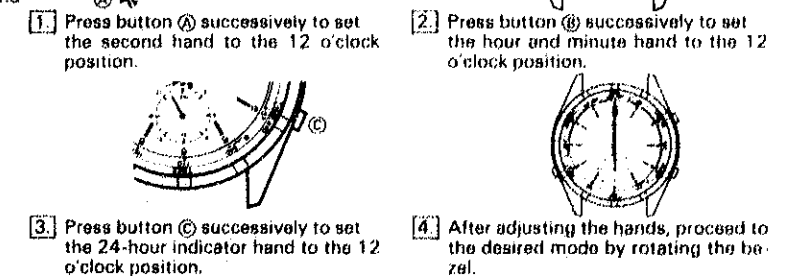

4. HOW TO SET THE TIME

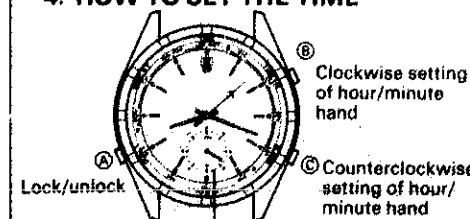

- Time scale: the 24-hour indication
- Turn the rotating bezel and set [TIME] or [TIME II] mark at the 12 o'clock position.
 - All the four hands move and point to the previously set time.
 - When the hands stop, proceed to [1] to [3] steps to adjust correct time.

● When the button is kept pressed for a few second, the hand moves rapidly. To stop the hand, press one of buttons.

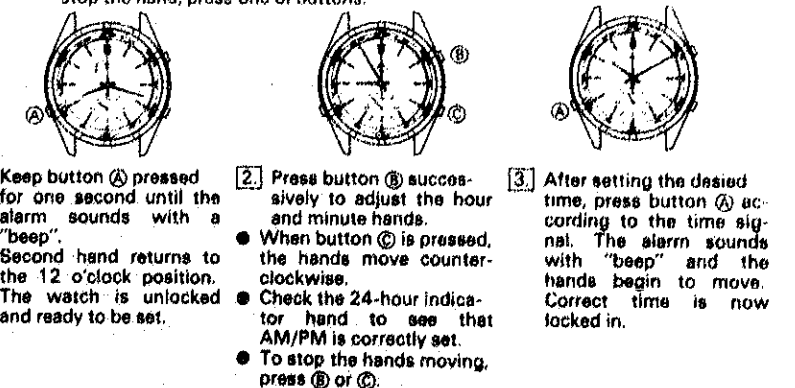

Note: After correcting the time more than 15 minutes in the [TIME] or [TIME II] mode, confirm that the [WORLD T] and the [DUAL T] times are not shifted. If the time is shifted, readjust them.





NOTE: REGARDING THE ALARM SET, WORLD TIME, DUAL TIME OPERATION, REFER TO THE INSTRUCTION BOOKLET.

IV. DISASSEMBLING, REASSEMBLING AND LUBRICATING

Disassembling procedures: Figs. ① → ④

Reassembling procedures: Figs. ④ → ①

Lubricating:

Types of oil	Oil quantity
Moebius A 	Small 
Seiko watch oil S-6 	Standard 

● Hands ~ Battery connection (-)

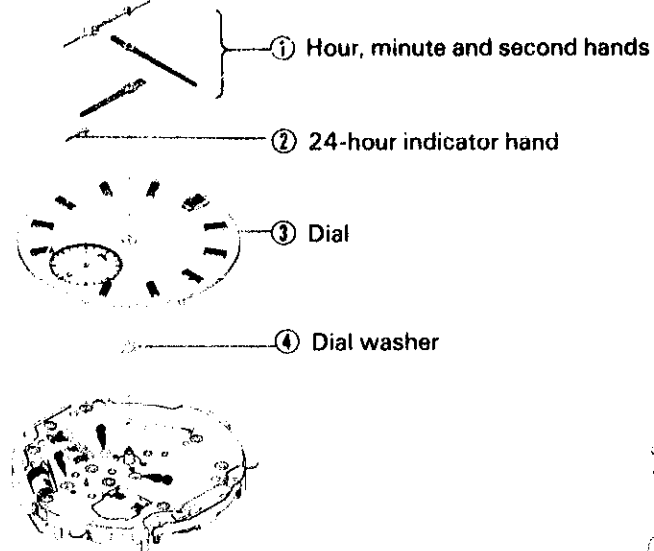

Note: Hands installation

Install the hands in the order of 24-hour indicator, hour, minute and second hand at the 12 o'clock position. At that time, take care not to misalign the hands.

<SYSTEM RESET AFTER REPLACING THE BATTERY>

Immediately after the battery is replaced, be sure to act the system reset according to any one of the following manners:

1. Keep the three buttons pressed simultaneously for a few seconds.
2. Short-circuit the AC (all clear) terminal of the circuit block and switch spring with conductive tweezers to reset the circuit.

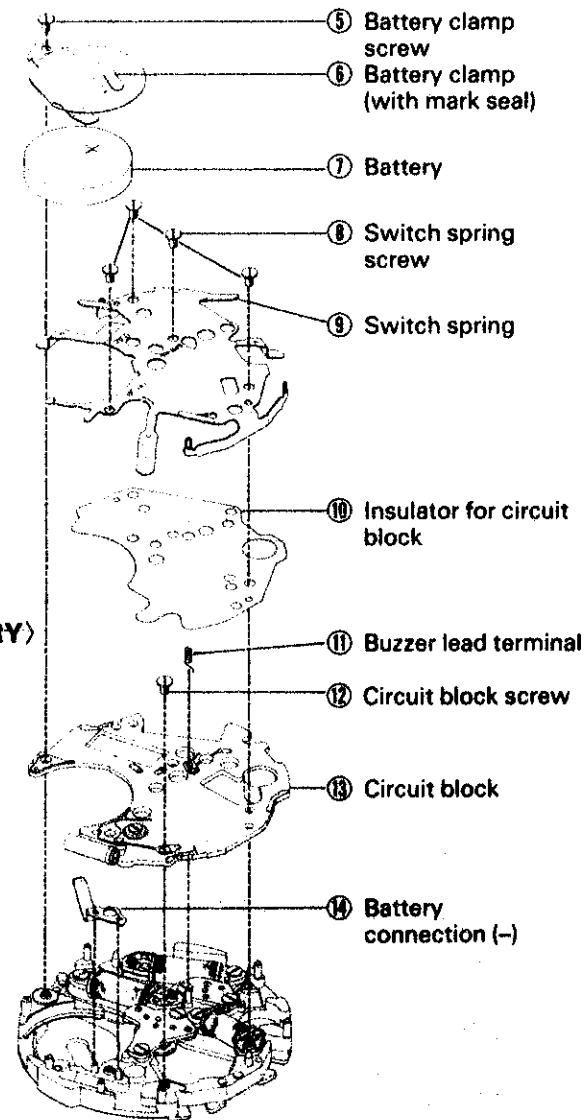

● Screw for additional train wheel bridge ~ Main plate

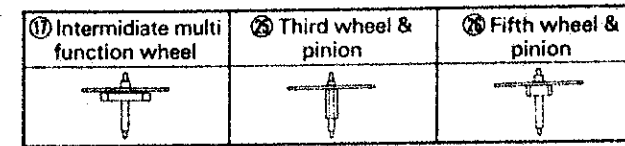

● Setting position of the train wheel

[Additional train wheel bridge]

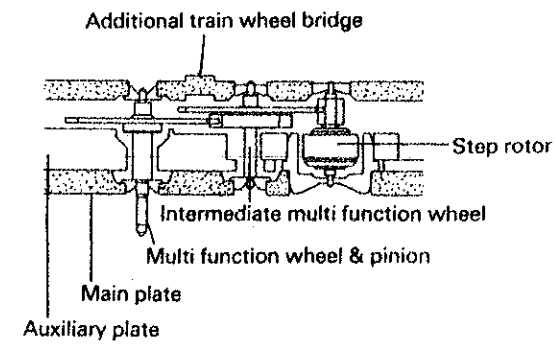

[Train wheel bridge]

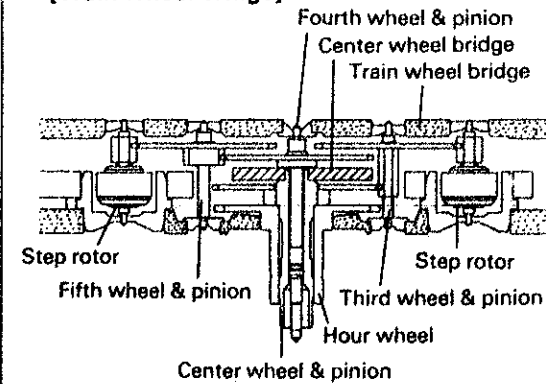

● Setting position of the coil block and rotor stator

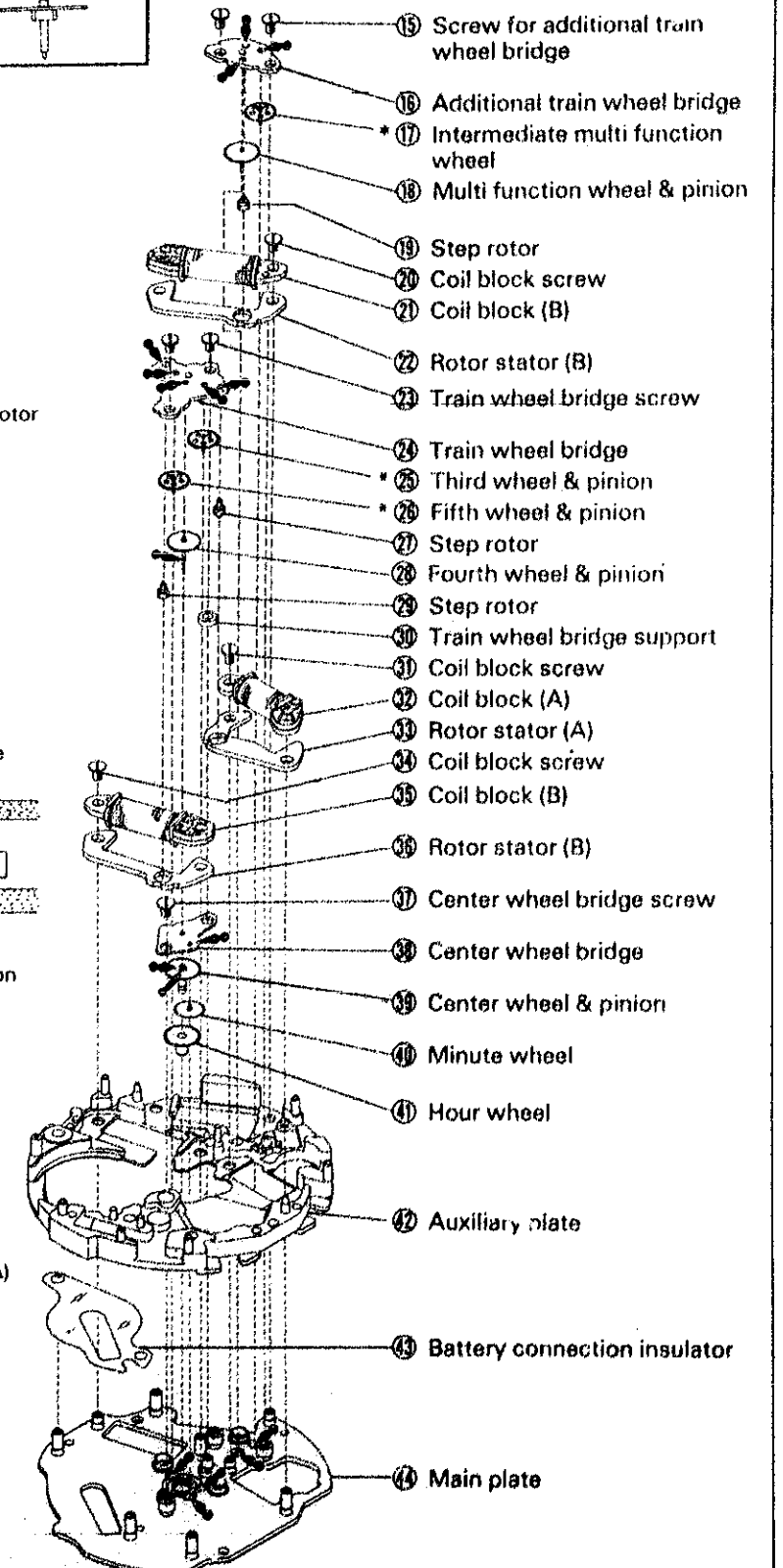
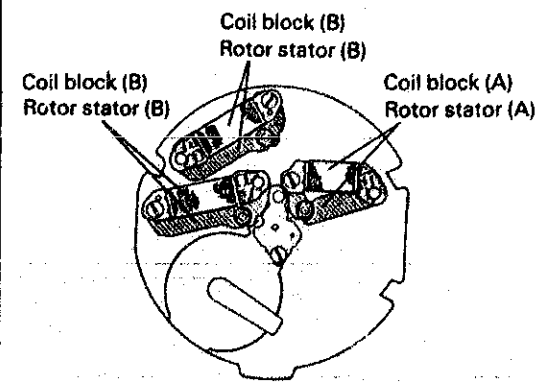

V. CHECKING AND ADJUSTMENT

1. Structure of circuit block

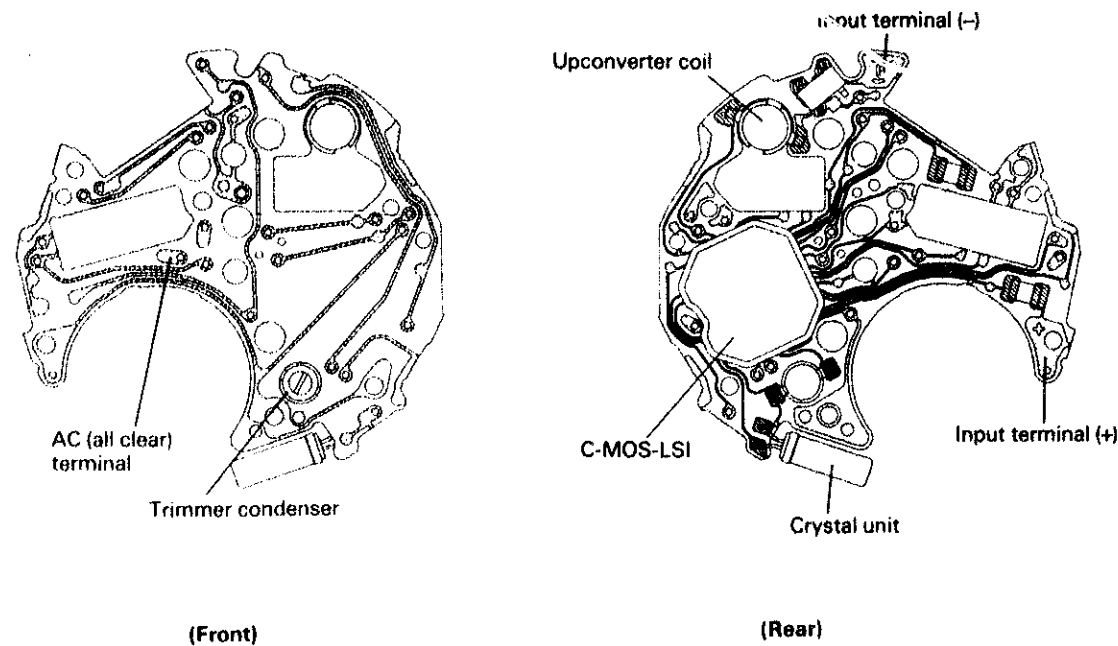

2. Procedure for checking and adjustment

- This section only gives the checking and adjustment procedure which is exclusive for this cal. V602A. For the normal checking and adjustment, refer to the "TECHNICAL GUIDE GENERAL INSTRUCTION, Analogue Quartz".

ACCURACY CHECK

Measuring gate by quartz tester: Any gate is available

- Measurement in Complete

NOTE:

Turn the rotating bezel to [TIME] or [TIME *H] mode to measure it.

- Measurement in Movement

NOTE:

As shown in the Fig. 1, insert the insulation vinyl sheet between the Switch and Circuit Block.

After then, reset the circuit to measure it.

Fig. 1

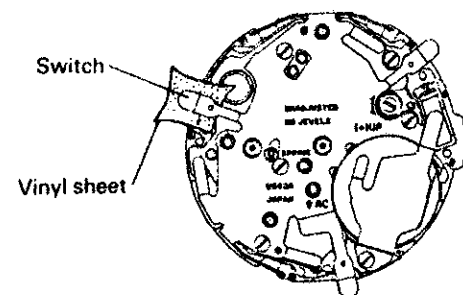

COIL BLOCK

Check the coil blocks (A) and (B) for broken wire and short circuit using the SEIKO Digital Multi Tester S-840A.
Range to be used: Ω

Result:

Coil block (A)

1.2 ~ 1.6k Ω : Normal

Less than 1.2k Ω (short circuit):
Defective

More than 1.6k Ω (broken wire):
Defective

Replace the coil block (A) with a new one

Result:

Coil block (B)

1.9 ~ 2.3k Ω : Normal

Less than 1.9k Ω (short circuit):
Defective

More than 2.3k Ω (broken wire):
Defective

Replace the coil block (B) with a new one

CURRENT CONSUMPTION

Use the SEIKO Digital Multi Tester S-840A (with Multi Adaptor MA-40A).
Range to be used: mA \rightarrow μ A
(When using the Volt-Ohm-Meter S-831, follow the same procedure as for the S-840A.)

① CHECK THE CURRENT CONSUMPTION FOR THE WHOLE OF THE MOVEMENT

NOTE:

- When measuring in complete condition, turn the rotating bezel to [TIME] or [TIME *H] mark at the 12 o'clock position.
- When measuring in movement condition, insert the insulation vinyl sheet between the switch and circuit block in the same way as the measurement gate by quartz tester. (Refer to fig. 1)

Procedures

- (1) First set the digital multi tester S-840A to mA range.
- (2) Connect the probes as shown in Fig. 2.
- (3) With condition (2), perform *SYSTEM RESET as shown in Fig. 3
*For initializing the IC data forcibly
- (4) When the current reading of the digital multi tester is stabilized, set the range from mA to μ A and read the current consumption value.

Fig. 2

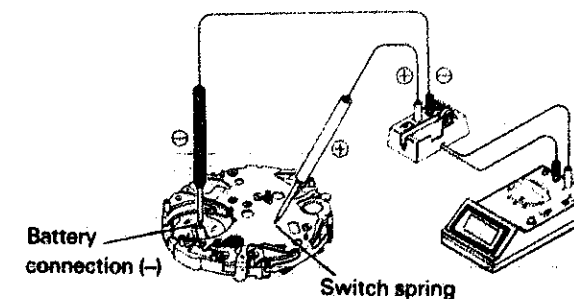

Result:

Less than 4.0 μ A: Normal

More than 4.0 μ A: Defective

Check the current consumption of the circuit block.

Fig. 3

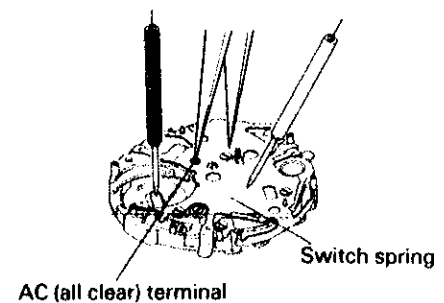

(SYSTEM RESET)

How to reset the circuit



Short-circuit the AC (all clear) terminal and switch spring with tweezers.

② CHECK THE CURRENT CONSUMPTION OF THE CIRCUIT BLOCK ALONE.

Procedures

1. First set the Digital Multi Tester S-840A to mA range.
2. After setting as shown in Fig. 4, reset the circuit by connecting the AC (all clear) terminal and red probe using the lead wire as shown below (Fig. 5).
3. When the current reading of the Digital Multi Tester is stabilized, set the range from mA to μ A and measure the current consumption.

Fig. 4

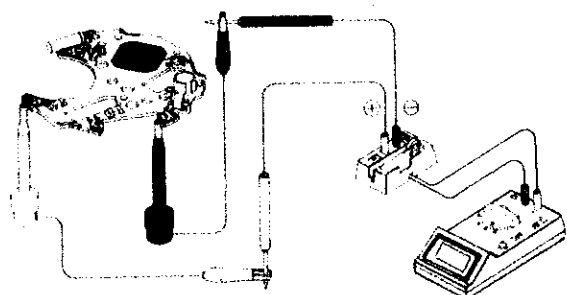
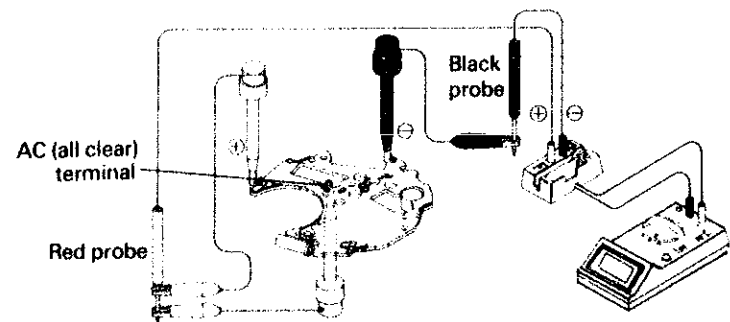

Fig. 5



(SYSTEM RESET) Turn the circuit block upside down and connect the AC terminal and red probe.

Result:
 Less than 1.8μ A: Normal
 More than 1.8μ A: Defective
 Replace the circuit block.

ALARM TEST SYSTEM

Turn the rotating bezel and set **Time** mark at the 12 o'clock position. Check to see if the alarm rings by pressing buttons **B** and **C** simultaneously.

Result:
 The alarm rings: Normal
 The alarm does not ring: Defective
 Proceed to the alarm condition.

ALARM CONDITION

① Check to see if the alarm output signal correctly transmitted from the circuit block.

Result:
 The output voltage is displayed intermittently: Normal
 (The alarm output signal is output.)

Keep buttons **B** and **C** pressed simultaneously with the desired mode set at the **TIME** position and check that the alarm signal is output.

● Use the SEIKO Digital Multi Tester (S-840A).

Range to be used: DCV

Red probe: A part of switch spring
 Black probe: Buzzer lead terminal

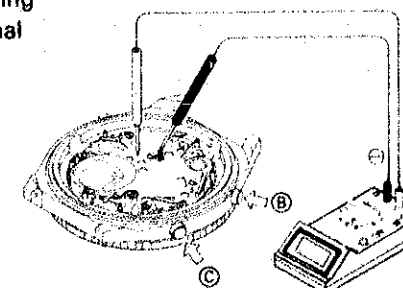

The digits displayed remain "00.0": Defective
 Check the upconverter coil.

② Check the upconverter coil.
 Range to be used: Ω

Result:
 $130\Omega - 170\Omega$: Normal
 Less than 130Ω
 More than 170Ω } : Defective
 Replace the circuit block.

③ Check the appearance of piezoelectric element.
 If items No. ① and ② above are normal, check the piezoelectric element. After checking, if separation, inadequacy or crack is detected, replace it with the new element.

VI. PARTS LIST

Cal. V602 A			
PARTS NO.	PARTS NAME	PARTS NO.	PARTS NAME
102 044	Auxiliary plate	4245 093	Switch spring
121 083	Center wheel bridge	4246 033	Buzzer lead terminal
125 083	Train wheel bridge	4270 062	Battery connection (-)
126 083	Additional train wheel bridge	4589 650	Piezoelectric element
221 039	Center wheel & pinion	012 201	Center wheel bridge screw
231 039	Third wheel & pinion	012 201	Train wheel bridge screw
241 097	Fourth wheel & pinion	012 201	Screw for additional train wheel bridge
261 039	Minute wheel	012 201	Circuit block screw
271 086	Hour wheel	012 201	Coil block screw
426 002	Train wheel bridge support	012 201	Switch spring screw
491 220	Dial washer	012 201	Battery clamp screw
701 013	Fifth wheel & pinion	032 048	Tube for circuit block screw
817 023	Intermediate multi function wheel	032 048	Tube for battery clamp screw
1002 012	Multi function wheel & pinion	032 048	Tube for switch spring screw
4000 358	Circuit block	032 049	Tube for coil block screw
4002 025	Coil block (B)	032 050	Tube for train wheel bridge (A)
4002 357	Coil block (A)	032 051	Tube for train wheel bridge (B)
4146 034	Step rotor	032 052	Tube for center wheel bridge
4216 067	Insulator for circuit block	032 064	Tube for train wheel bridge (C)
4216 069	Battery connection insulator	● SEIKO	SR1130W
4225 068	Battery clamp	● MAXELL	SR1130W
4239 042	Rotor stator (A)	● U.C.C.	389
4239 043	Rotor stator (B)	● SONY EVEREADY	389
			} Battery

REMARKS :

SWITCH SPRING FOR PULSAR WATCHES

4245092 (Pulsar marking)