

TECHNICAL GUIDE AND PARTS LIST

CAL. V231A

ANALOGUE QUARTZ

CONTENTS

I. SPECIFICATIONS	1
II. STRUCTURE OF CIRCUIT BLOCK.....	1
III. DISASSEMBLING, REASSEMBLING AND LUBRICATING	2
● Hands ~ Hour wheel.....	2
● Battery clamp screw ~ Winding stem.....	3
● Train wheel bridge screw ~ Main plate.....	4
IV. CHECKING AND ADJUSTMENT	5 ~ 7
V. PARTS LIST.....	8

I. SPECIFICATIONS

Item	Cal. No.	V231A
Indication system	3 hands	
Additional mechanism	Electronic reset switch Second setting device	
Loss/gain	Monthly rate: Less than 20 seconds at normal temperature range	
Size of main plate	15.5 mm (6H - 12H) x 13.0 mm (3H - 9H)	
Casing diameter	15.1 mm	
Height	2.4 mm (including battery)	
Quartz Tester measuring gate	10-second gate	
Battery	SEIZAIKEN TR521SW Voltage: 1.55V Battery life: Approx. 2 years	
Jewels	0 jewel	

II. STRUCTURE OF CIRCUIT BLOCK

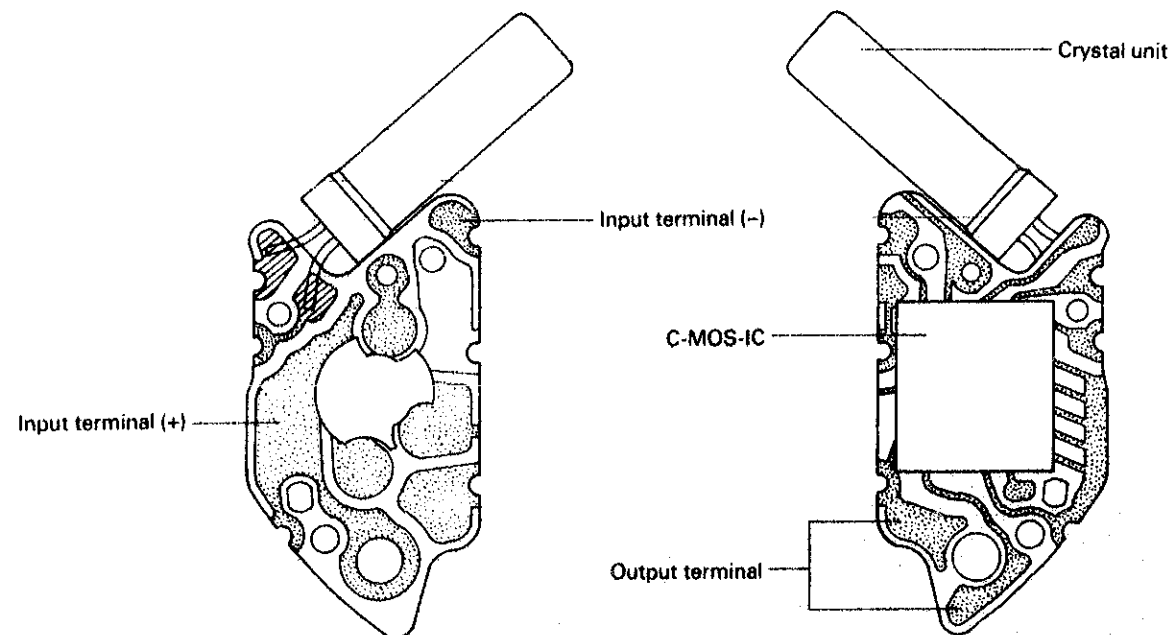





III. DISASSEMBLING, REASSEMBLING AND LUBRICATING

Disassembling procedures: Figs ① ~ ③③
Reassembling procedures: Figs ③③ ~ ①

● Hands ~ Hour wheel

Lubricating:

Types of oil	Oil quantity
Moebius A 	Small 
Seiko oil S-6 	Standard 

② The dial legs are inserted into the holes in the Dial spacer ② and Winding stem cock ⑬.
* To remove the dial, insert a small screwdriver into the notches for dial removal of the main plate (2 portions) and lift the dial out.

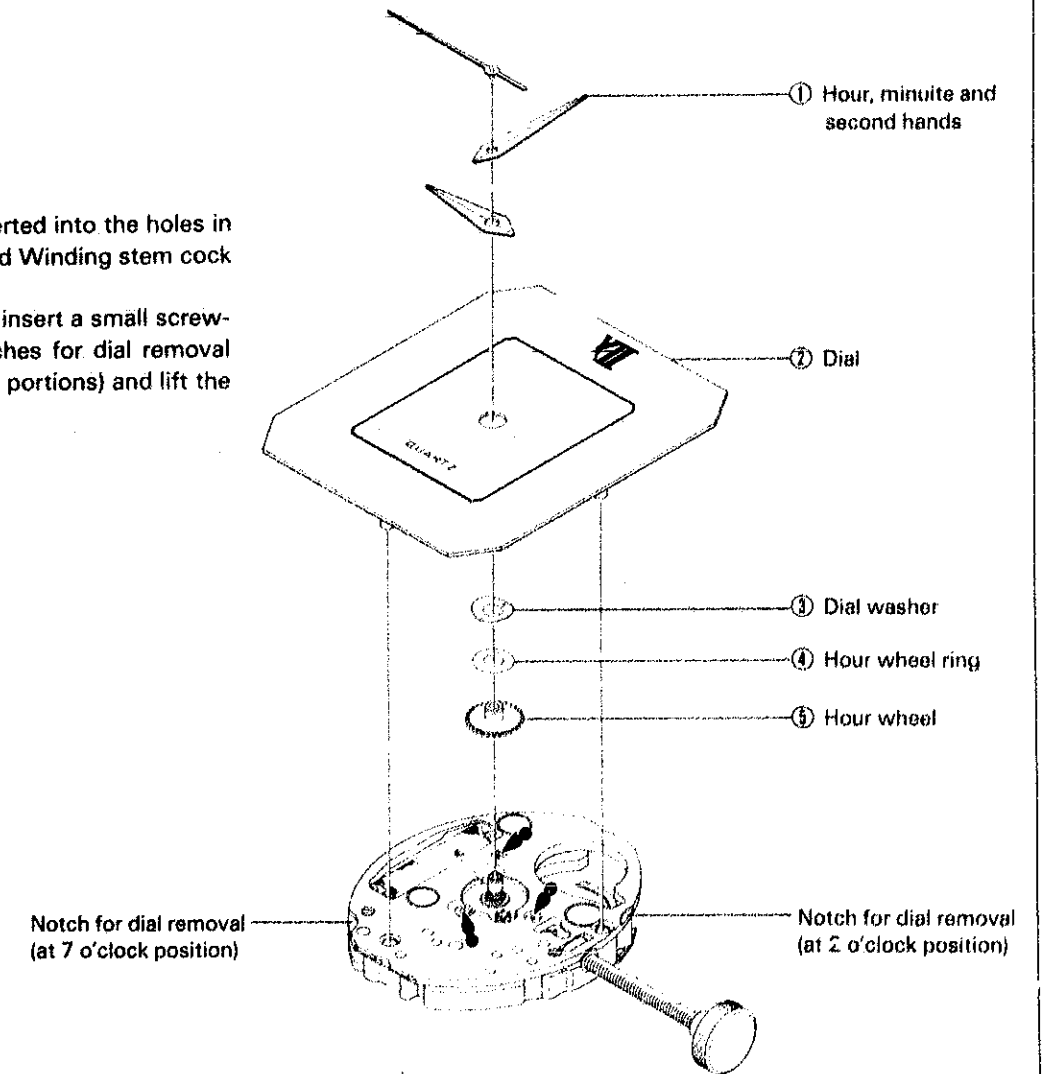

* Removing/installing winding stem

Insert a screwdriver in the direction of arrow between the Winding stem holder ⑪ and Winding stem cock ⑬ and pull out the winding stem while lifting up the winding stem holder.

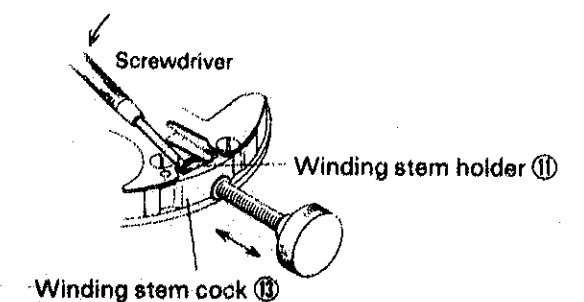

● Battery clamp screw ~ Train wheel bridge

* In some models, a battery clamp and battery clamp screw is used.

⑩ Train wheel setting lever
[Side view]

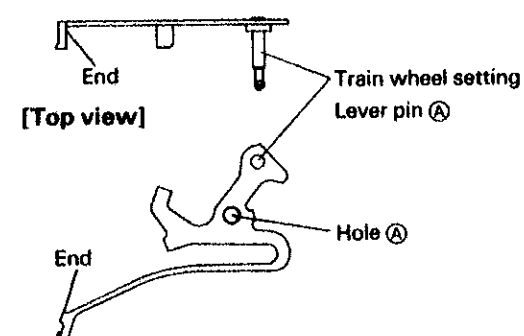

● Setting position of Train wheel setting lever

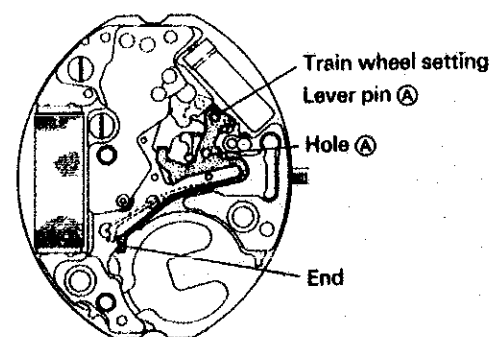

[How to set the train wheel setting lever]

- ① Set the hole (A) of the train wheel setting lever over the pin (B) of the train wheel bridge (12).
- ② Set the train wheel setting lever pin (A) in to the hole (B) of the reset lever (26).
- ③ Hang the end of the train wheel setting lever on the train wheel bridge.

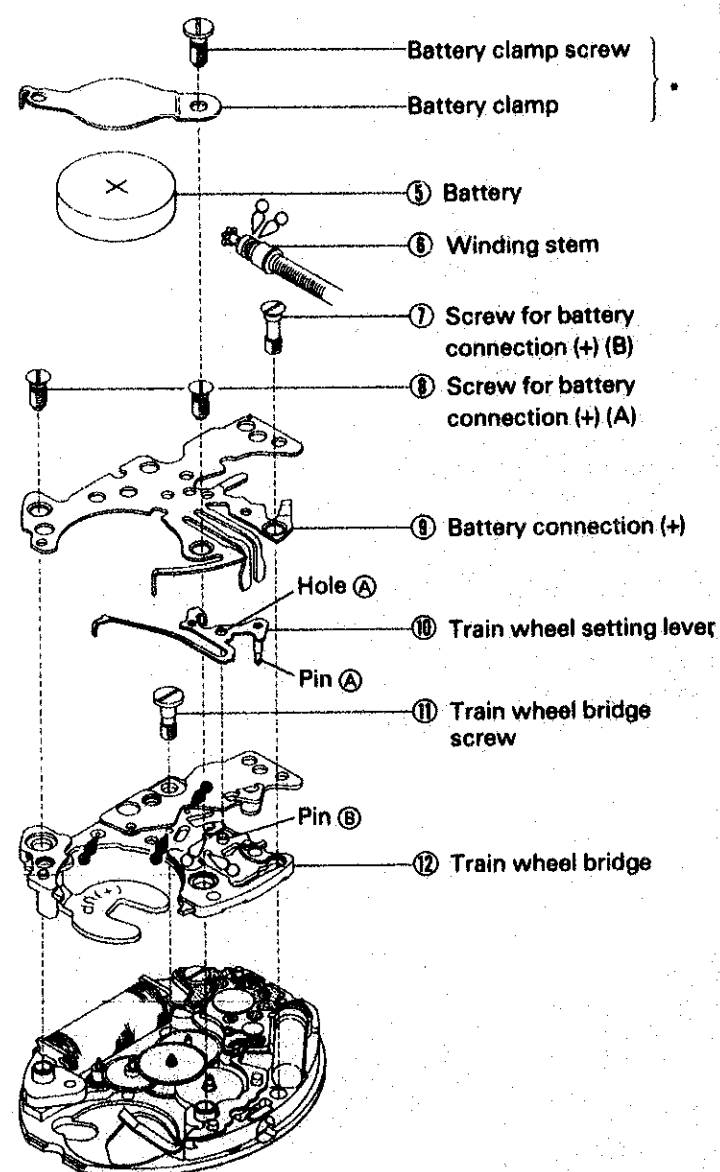

● Battery connection (-) ~ Main plate

● Setting position of the gear train
[Side view]

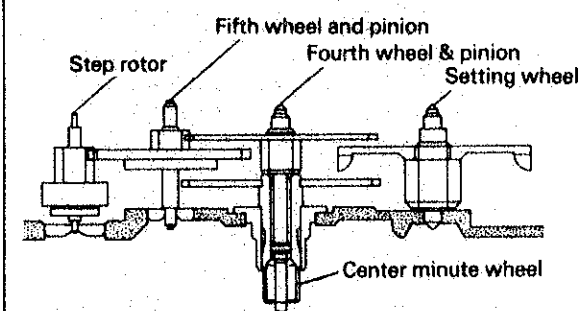

[Top view]

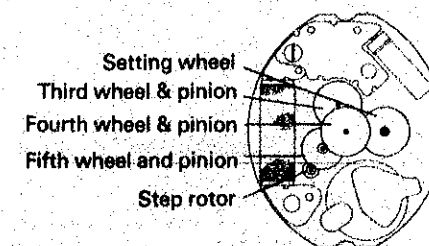

Note:
Fifth wheel and pinion (15) is made of plastic, take care not to damage the wheel, pinion and shaft.

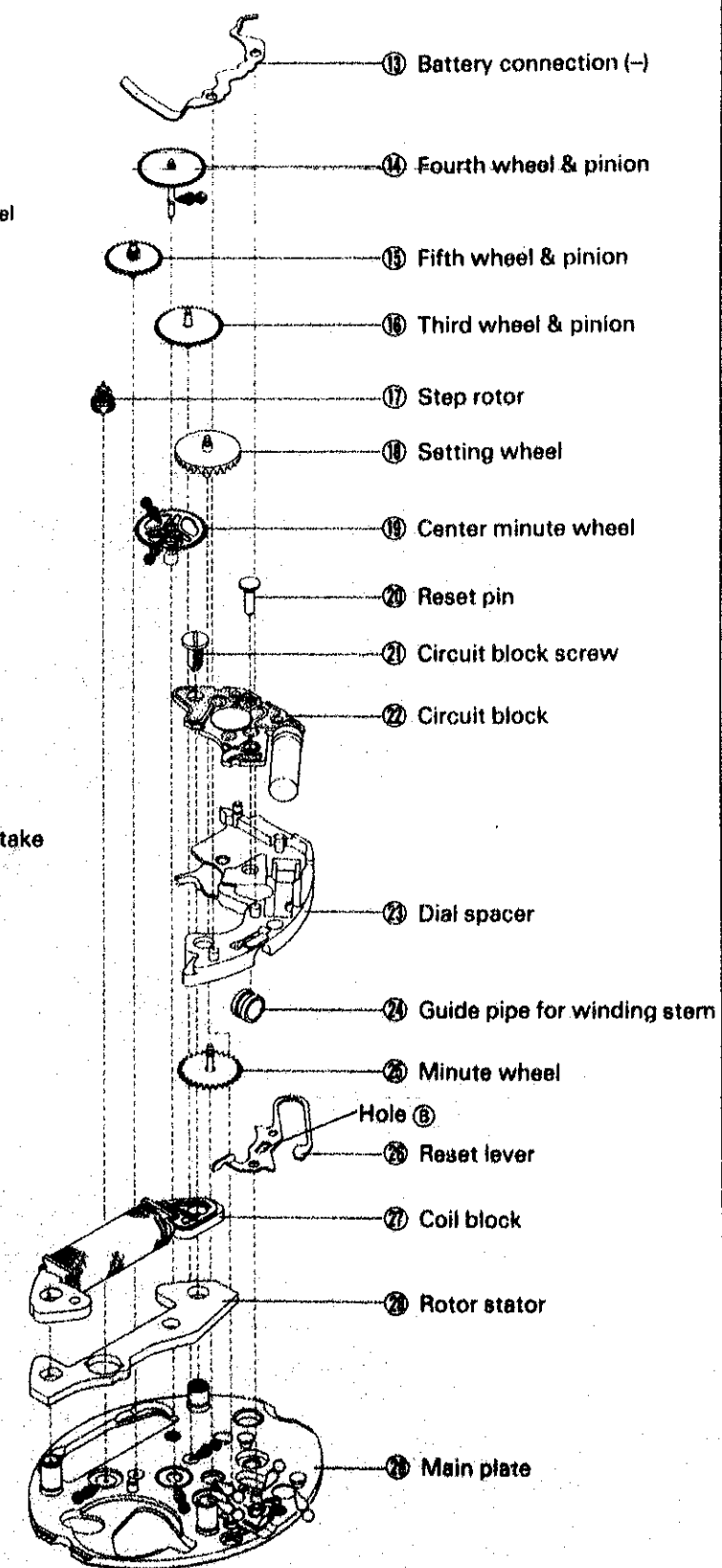

IV. CHECKING AND ADJUSTMENT

Procedure for checking and adjustment

- This section only gives the checking and adjustment procedure which is exclusive for this watch.
For the normal checking and adjustment, refer to the "TECHNICAL GUIDE GENERAL INSTRUCTION, Analogue Quartz".
- The page numbers in the item correspond to those in the "TECHNICAL GUIDE GENERAL INSTRUCTION, Analogue Quartz".

OUTPUT SIGNAL p.6	
1. Use the Quartz Tester. 2. Turn the measuring gate selection switch to "10-second" gate. NOTE: Checking should be made with the crown set to normal position.	Result: Output signal: Normal No output signal: Defective
BATTERY VOLTAGE	
Use the Digital Multi Tester S-840A. Range to be used: DC V	Result: 1.57V or more: Normal Less than 1.57V: Defective Replace the battery.
BATTERY CONDUCTIVITY p.9	
Check the conductivity between battery and battery connection (-), etc.	
CIRCUIT BLOCK CONDUCTIVITY p.9	
Check the output terminal and pattern section contamination in the circuit block and check if the circuit is broken or short.	
COIL BLOCK	
Check the coil block for broken wire and short circuit using the Digital Multi Tester S-840A. Range to be used: Ω	Result: 2.9 ~ 3.3 k Ω : Normal Less than 2.9 k Ω (Short circuit): Defective More than 3.3 k Ω (Broken wire): Defective Replace the coil block.
FRONT GEAR TRAIN MECHANISM p.11	
Check the front gear train mechanism for play of step rotor and wheels and pinions, mis-installation, dust, lint, foreign matter, lubrication, etc.	
BACK GEAR TRAIN MECHANISM p.11	
Check the back gear train mechanism for lubrication leakage, play, dust, lint, etc.	

RESET CONDITION

With the movement installed, check that the reset condition is normal.

1. Check the clearance between the train wheel setting lever and fourth wheel and pinion.

(1) Check the clearance with the crown at normal position.

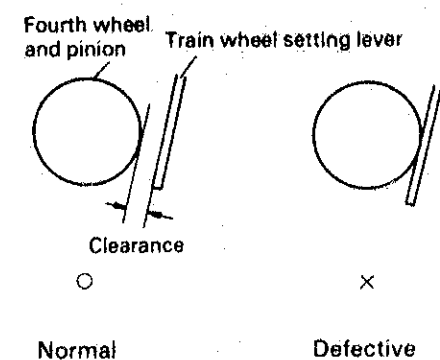

(2) Check the clearance with the crown at first click position.

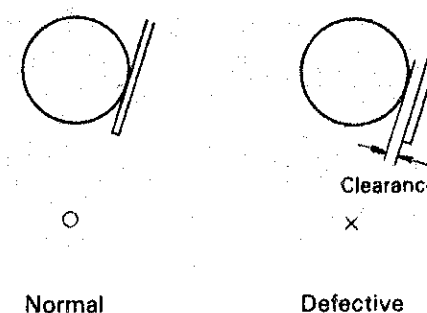

2. Check the output signal with the battery installed.

(1) Check the output signal with the crown at normal position.

(2) Check the output signal with the crown at first click position.

ACCURACY p.13

Check accuracy using Quartz Tester (10-second gate) and an electromagnetic microphone (DM-1).

NOTE:

Check accuracy with the crown at normal position.

Result:
Clearance: Normal
No clearance: Defective
Replace the train wheel setting lever.

Result:
No clearance: Normal
Clearance: Defective
Replace the train wheel setting lever.

Result:
Output signal: Normal
No output signal: Defective
Replace the reset lever.

Result:
No output signal: Normal
Output signal: Defective
Replace the reset lever.

Result:
Monthly rate (at normal temperature range)
Less than 20 seconds: Normal
More than 20 seconds: Defective
Replace the circuit block

CURRENT CONSUMPTION

Use the Digital Multi Tester S-840A (with Multi Adaptor MA-40).
Mode: μA

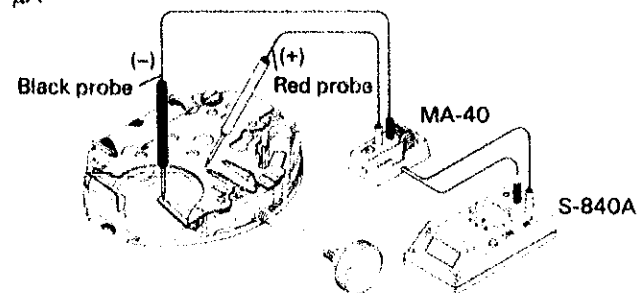

NOTE:

Press the reset switch to read 00.0 μA and measure the current consumption.

Red probe → Battery connection (+)

Black probe → Battery connection (-)

When measuring the current consumption under the incandescent lamp, cover the movement with black cloth. Otherwise the measured value sometimes becomes higher than the actual value.

Result:
0.9 μA or less: Normal
More than 0.9 μA : Defective
Replace the circuit block

V. PARTS LIST

Cal. V231 A			
PARTS NO.	PARTS NAME	PARTS NO.	PARTS NAME
125 237	Train wheel bridge	493 122	Hour wheel ring (Thickness 0.07mm)
197 234	Winding stem cock	701 235	Fifth wheel
231 234	Third wheel & pinion	735 231	Winding stem holder
238 232	Guide pipe for winding stem	4000 251	Circuit block
* 241 236	Fourth wheel & pinion	4002 251	Coil block
* 241 280	Fourth wheel & pinion	4146 235	Step rotor
* 241 282	Fourth wheel & pinion	4225 230	Battery clamp
261 231	Minute wheel	4239 235	Rotor sator
* 270 236	Center minute wheel	4271 241	Battery connection(+)
* 270 280	Center minute wheel	4408 238	Dial spacer
* 270 282	Center minute wheel	4455 236	Reset lever
* 271 235	Hour wheel	012 010	Battery clamp screw
* 271 236	Hour wheel	012 024	Circuit block screw
* 271 281	Hour wheel	012 495	Train wheel bridge screw
* 271 282	Hour wheel	012 818	Screw for battery connection (+) (A)
281 235	Setting wheel	012 819	Screw for battery connection (+) (B)
* 354 235	Winding stem ($\phi 80$)	017 591	Reset pin
* 354 236	Winding stem ($\phi 90$)	017 662	Tube for train wheel bridge (A)
387 235	Minute wheel bridge	017 663	Tube for train wheel bridge (B)
391 232	Train wheel setting lever	017 664	Tube for train wheel bridge (C)
491 141	Dial washer	017 784	Lower bush for step rotor
493 120	Hour wheel ring (Thickness 0.03mm)	SEIZAIKEN TR521SW	Battery
493 121	Hour wheel ring (Thickness 0.05mm)		

Remarks:

* Fourth wheel & pinion, Center minute wheel, Hour wheel

There are four different types as specified below:

Combination:

Type	Fourth wheel & pinion	Center minute wheel	Hour wheel
M	241 236	270 236	271 236
T	241 236	270 236	271 281
S	241 280	270 280	271 235
L	241 282	270 282	271 282

* Winding stem.

The type of winding stem is determined based on the design of case.