

SEIKO

DIGITAL QUARTZ

Cal. S021A

PARTS LIST

Cal. S021A

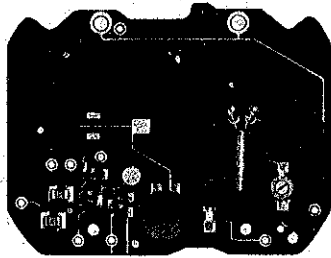
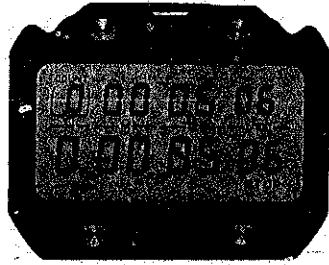

4001 200

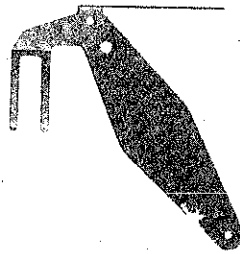

4225 200



4246 200



4246 201

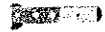

4270 200



4293 200



4313 200

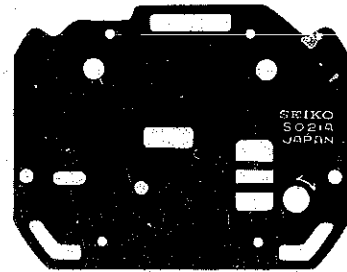

4398 201

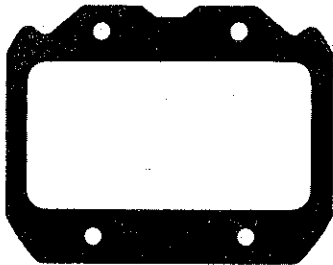

4398 205



4450 200

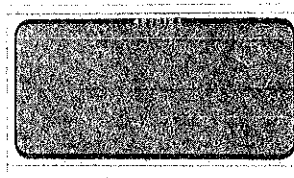

4510 121



☆Maxell SR43W

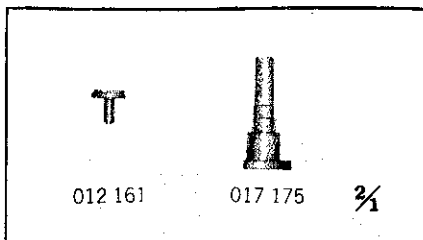

012 161

017 175

3/1

Cal. S021A

Characteristics

Casing diameter: 34.3 mm×43.0 mm
 Maximum height: 9.4 mm without battery
 Frequency of quartz crystal oscillator: 32,768 Hz (Hz=Hertz Cycles per second)
 Stopwatch display: Digital Display System showing hour, minute, second and 1/100 second up to 10 hours on both the upper row and the lower row. The standard lap time and the section lap time are displayed by button operation.
 Interval timer display: Digital Display System showing hour, minute, second and 1/100 second on both the upper row and the lower row.
 Count display: In the stopwatch function, it indicates the number of times that the lap time is measured. In the interval timer function, it indicates the number of times that the countdown is repeated.
 Display medium: Nematic Liquid Crystal, FE-Mode
 Regulation System: Trimmer condenser
 Battery life indicator: All the digits in the display begin flashing.

PART NO.	PART NAME	PART NO.	PART NAME
4001 200	Circuit block		
4225 200	Holding spring for battery		
4246 200	Buzzer lead terminal		
4246 201	Ground terminal		
4270 200	Battery connection (-)		
4293 200	Switch cock		
4313 200	Connector		
4398 201	Battery guard		
4398 205	Liquid crystal panel frame		
4450 200	Switch lever		
4510 121	Liquid crystal panel		
012 161	Module fixing screw		
017 175	Module fixing tube		
☆Maxell SR43W ☆U. C. C. 386 ☆SONY EVEREADY 386	Silver oxide battery		

Remarks:

Battery

- ☆Maxell SR43W
- ☆U. C. C. 386
- ☆SONY EVEREADY 386

} The applied battery for this calibre might be added the substitutive in the future. In that case, please refer to separate "BATTERIES FOR SEIKO QUARTZ WATCHES".

☆ ⇨ Please see remarks.

Part numbers in light letters are not shown in photos.

TECHNICAL GUIDE

SEIKO DIGITAL QUARTZ

CAL. S021 A

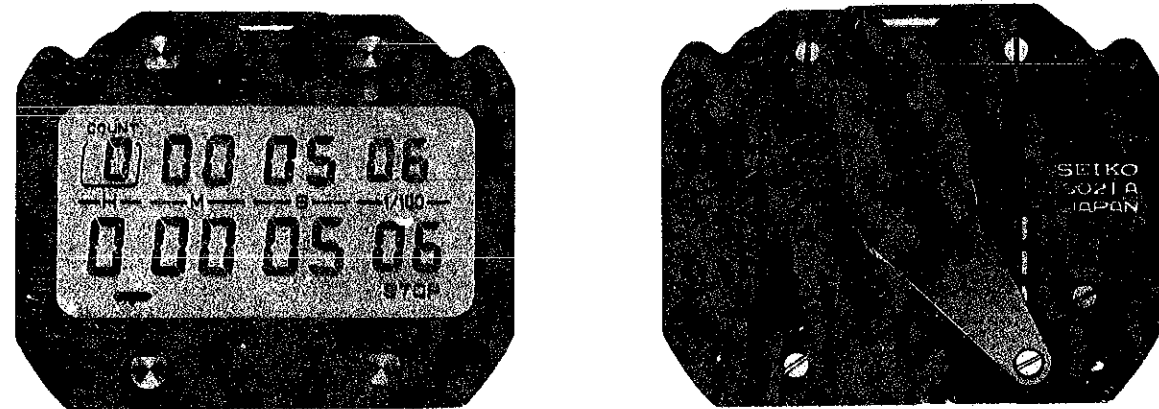

CONTENTS

I. SPECIFICATIONS	2
1. Specifications	2
2. Piezo-electric buzzer	3
3. After-sale servicing instruments and materials	3
II. DISASSEMBLING AND REASSEMBLING OF THE CASE	4
III. DISASSEMBLING, REASSEMBLING AND LUBRICATING	6
IV. CHECKING AND ADJUSTMENT	9
1. Guide table for checking and adjustment	9
2. Designation of the segment electrode of liquid crystal panel	10
3. Procedures for checking and adjustment	11
A : Check battery voltage	11
• Check pattern segment checking system	11
B : Check conductivity of liquid crystal panel, circuit block and connector	11
C : Check circuit block and liquid crystal panel	12
D : Check current consumption	13
E : Check accuracy	14
F : Check conductivity of switch components	14
G : Check alarm condition	15
H : Check functioning and adjustment	16

SEIKO Digital Stopwatch Cal. S021 ----- Quartz Crystal Oscillator Stopwatch with Interval Timer

SEIKO Digital Stopwatch with interval timer Cal. S021 is an easy-to-use, highly reliable digital chronograph which can measure from 1/100 second up to 10 hours (9 hours, 59 minutes and 59 seconds).

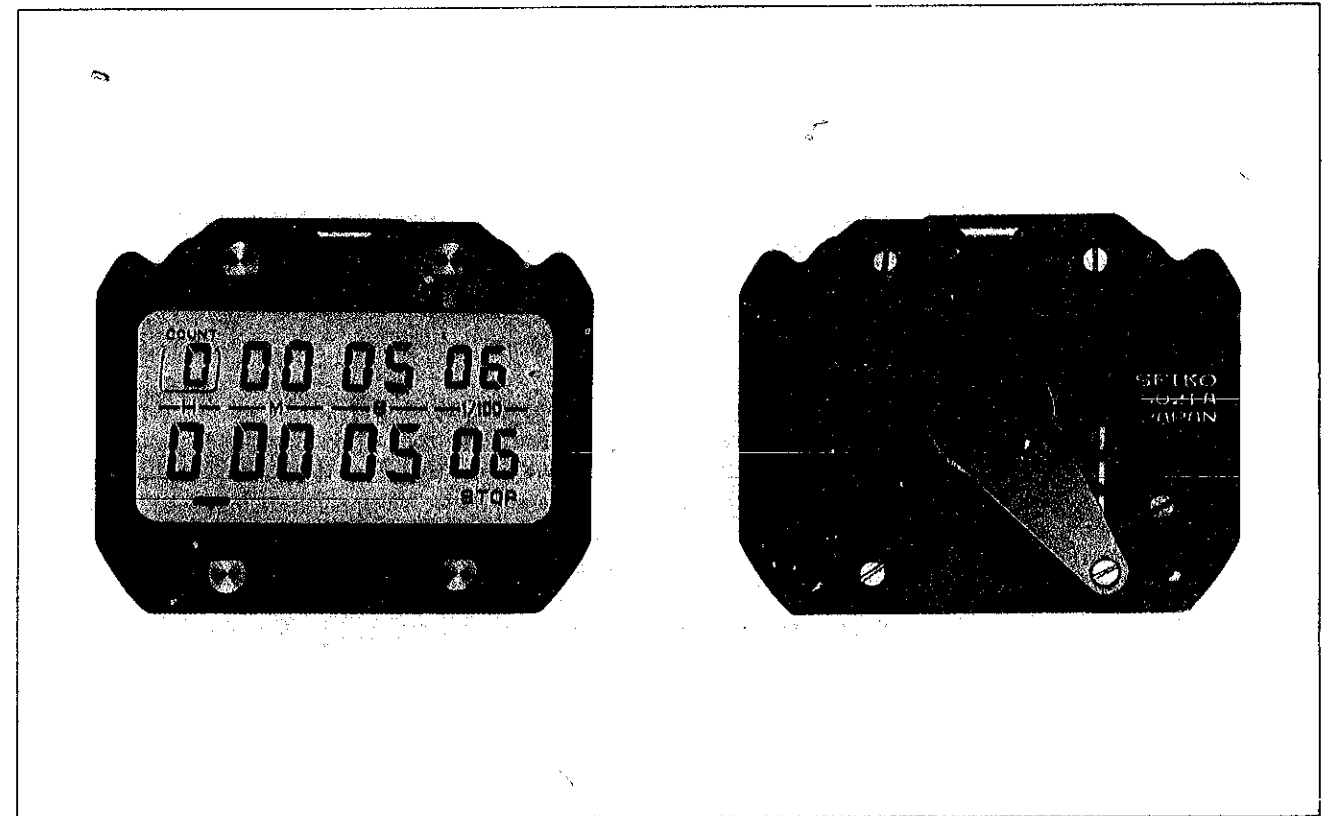

Features

- Cal. S021 is provided with two functions, a stopwatch function and an interval timer function, and either of the two functions can be selected to meet your requirements.
- The stopwatch function is capable of measuring a standard lap time and a section lap time simultaneously. The standard lap time is the elapsed time from the time an event such as a marathon or swimming race was started to the time the lap button was depressed. The section lap time is the elapsed time for each segment of the event.
- The interval timer function rings the alarm at every set interval. (The time interval can be set from 1/10 second up to 10 hours (9 hours, 59 minutes and 59 seconds)).
- In the stopwatch display, the lap counter is activated, and in the interval timer display, the timer counter is activated.
- All the digits in the display start flashing when the battery life nears its end.

I. SPECIFICATIONS

1. Specifications

Item	Calibre No.	S021A
Display medium		Nematic Liquid Crystal, FEM (Field Effect Mode)
Display system		<p>Two-display changeover system with the stopwatch display and the interval timer display (with alarm).</p> <ul style="list-style-type: none"> • Stopwatch display Hour, minute, second, and 1/100 second are displayed. It can measure from 1/100 second up to 10 hours (9 hours, 59 minutes and 59 seconds). (Section lap time is displayed in the upper row and standard lap time is displayed in the lower row at the same time.) The LAP, LAP RUN, STOP and a function mark are displayed. The lap counter indicates the number of lap time measurements and when a button is depressed, the alarm rings with a single "peep" to indicate that the button is depressed. • Interval timer display Hour (10-hour indication), minute, second and 1/100 second can be set to operate for any desired amount of time from 1/10 second to 10 hours (9 hours, 59 minutes and 59 seconds). The time interval set is displayed in the upper row and the time interval to be counted down is displayed in the lower row. STOP and a function mark are displayed. The timer counter indicates the number of countdowns repeated.
Additional mechanism		<ul style="list-style-type: none"> • Battery life indicator (All the digits in the display start flashing when the battery life nears its end.) • When a button is depressed, the alarm rings with a single "peep" to indicate that the button is depressed. • In the interval timer function, the alarm rings at every set interval.
Crystal oscillator		32,768 Hz (Hz = Hertz Cycles per second)
Loss/gain		Loss/gain at normal temperature range 99.9992% (equivalent to the mean monthly rate of less than 20 seconds)
Casing diameter		34.3 mm (between 6 o'clock and 12 o'clock side) 43.0 mm (between 3 o'clock and 9 o'clock side)
Height		9.4 mm
Operational temperature range		-10°C ~ +60°C (14°F ~ 140°F)
Regulation system		Trimmer condenser
Battery power		Battery life is approximately 3 years (If the alarm is used for less than 30 seconds daily.) Silver oxide battery U.C.C. 386, SONY EVEREADY 386 or Maxell SR43W Voltage: 1.55V
IC (Integrated Circuit)		C-MOS-LSI . . . 1 piece

2. Piezo-electric buzzer

- Unlike some existing alarm watches which adopt an electromagnetic alarm, Cal. S021 employs a piezo-electric buzzer using a piezo-electric element. A piezo-electric element is mechanically distorted like the crystal oscillator when voltage is applied to it, and the distortion causes the entire case back to vibrate and buzz.

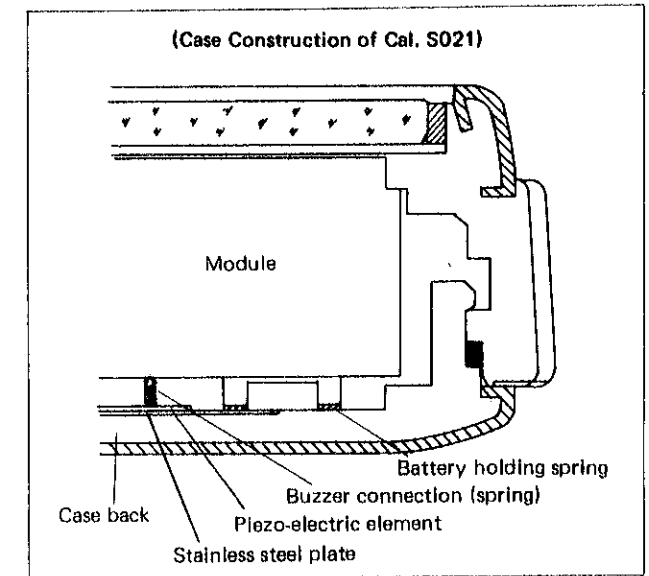

- The piezo-electric element is made of ceramics with an electrode on both sides. It is attached to a stainless steel plate and then to the case back. The stainless steel plate is used to secure conductivity between the electrode on the lower side of the piezo-electric element and the module.
(Poor adhesion between the piezo-electric element and the case back, a crack in the piezo-electric element or a broken upper converter coil may cause a faulty buzzer. Be careful when disassembling, reassembling or otherwise handling the buzzer portions.)

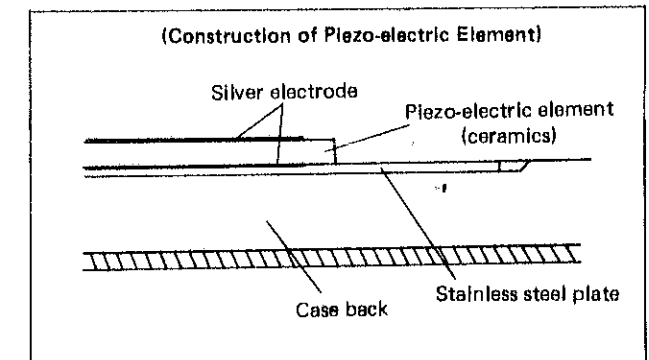

3. After-sale Servicing Instruments and Materials

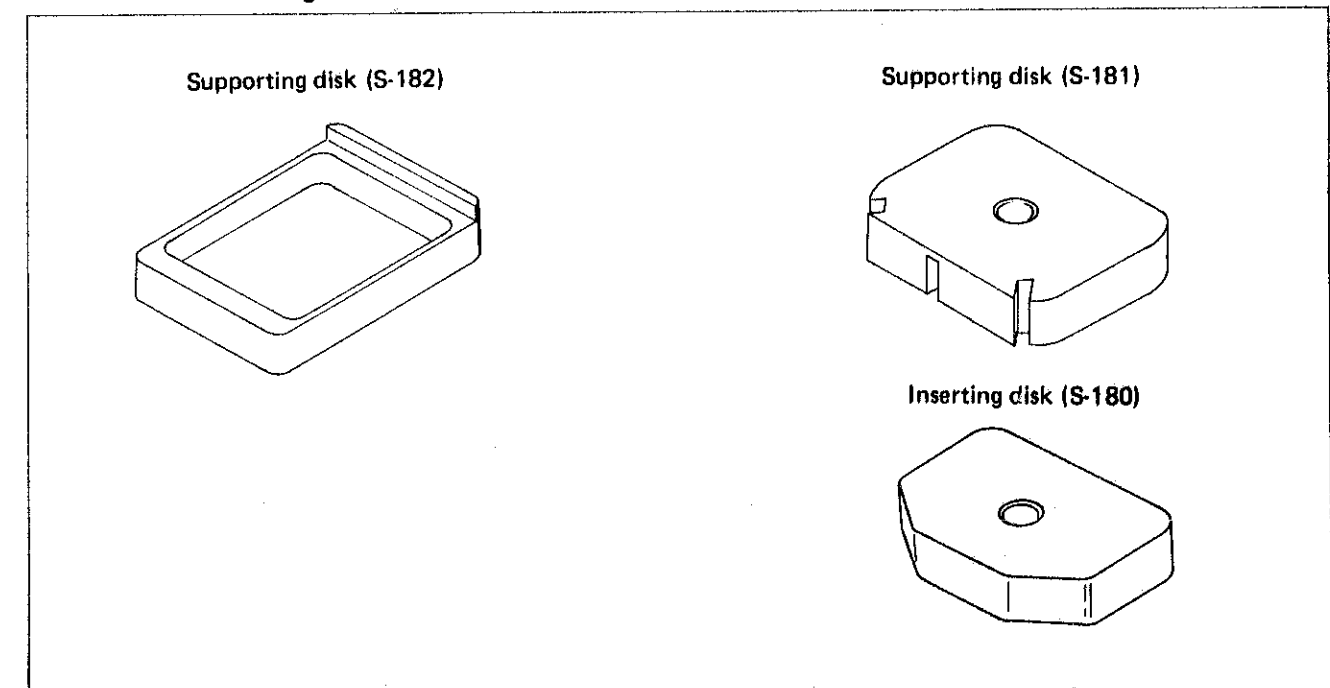

II. DISASSEMBLING AND REASSEMBLING OF THE CASE

Disassembling procedures Figs.: ① → ④

Reassembling procedures Figs.: ④ → ①

Lubricating: Silicone grease 500,000 c.s.

Normal quantity 

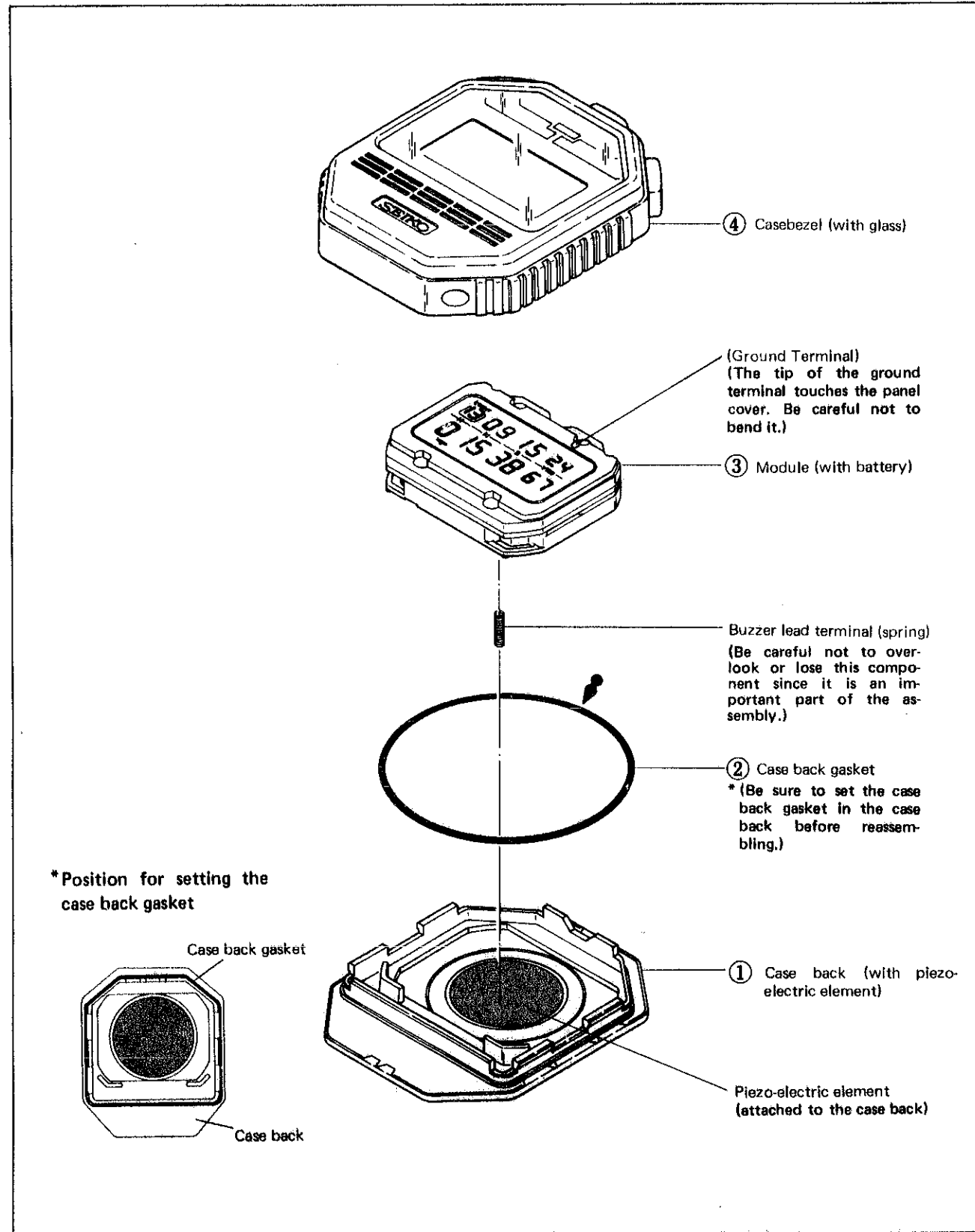

Remarks for disassembling and reassembling

①. Case back

How to disassemble

- Disassemble the case back by inserting the edge of the case opener into the opening notches on the 3 and 9 o'clock sides.
- The case back may not be disassembled by prying one opening notch only.
- Be careful not to cut the case back gasket with the case opener.

How to reassemble

1. Set one of the projections on the 3 and 9 o'clock sides of the case back.
2. Set the other projection of the case back while pushing the case back toward its center with fingers.
3. When reassembling the case back, be sure that the buzzer connection (spring) is in the correct position. The case back does not buzz without the buzzer connection (spring).

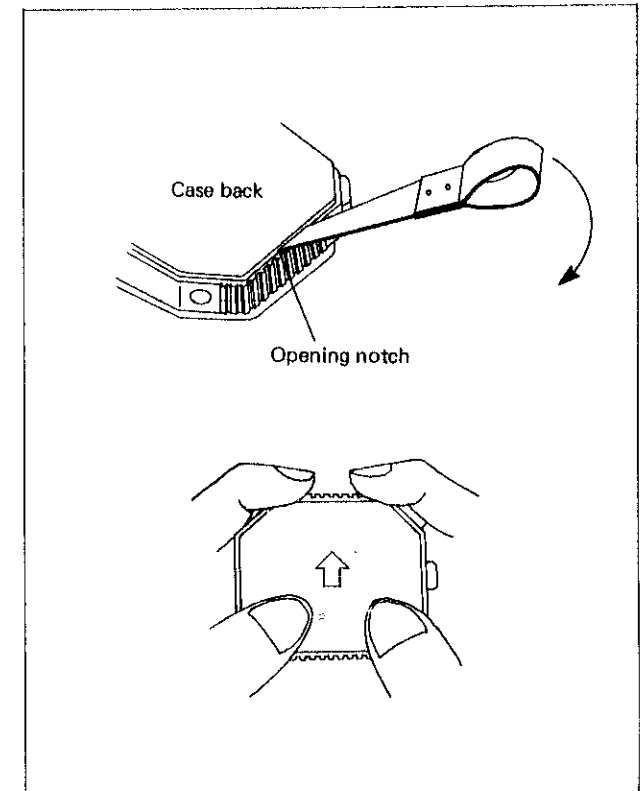

How to replace the glass

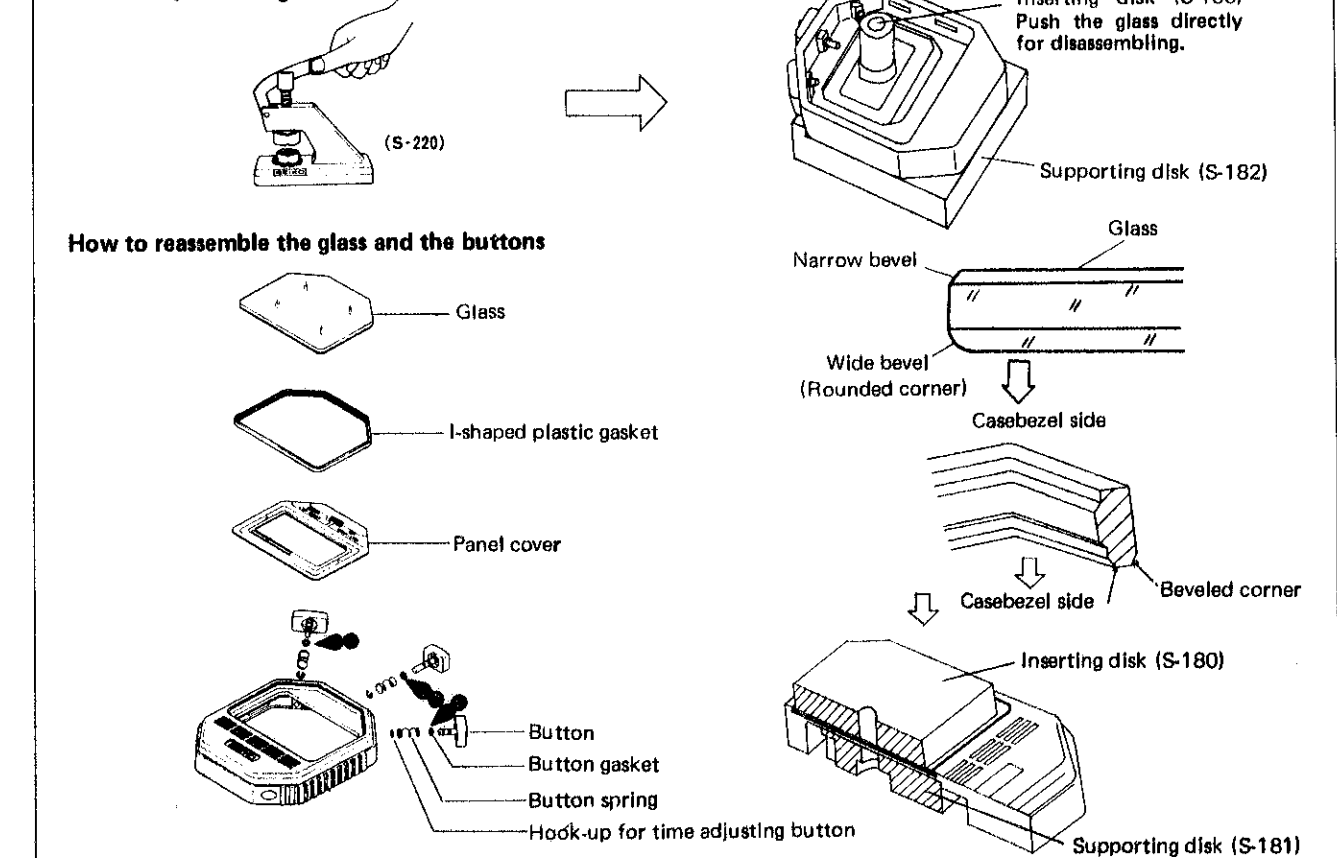

III. DISASSEMBLING, REASSEMBLING AND LUBRICATING

Disassembling procedures Figs.: ① → ⑬

Reassembling procedures Figs.: ⑬ → ①

Lubricating: SEIKO Watch Oil S-6

Normal quantity ∞

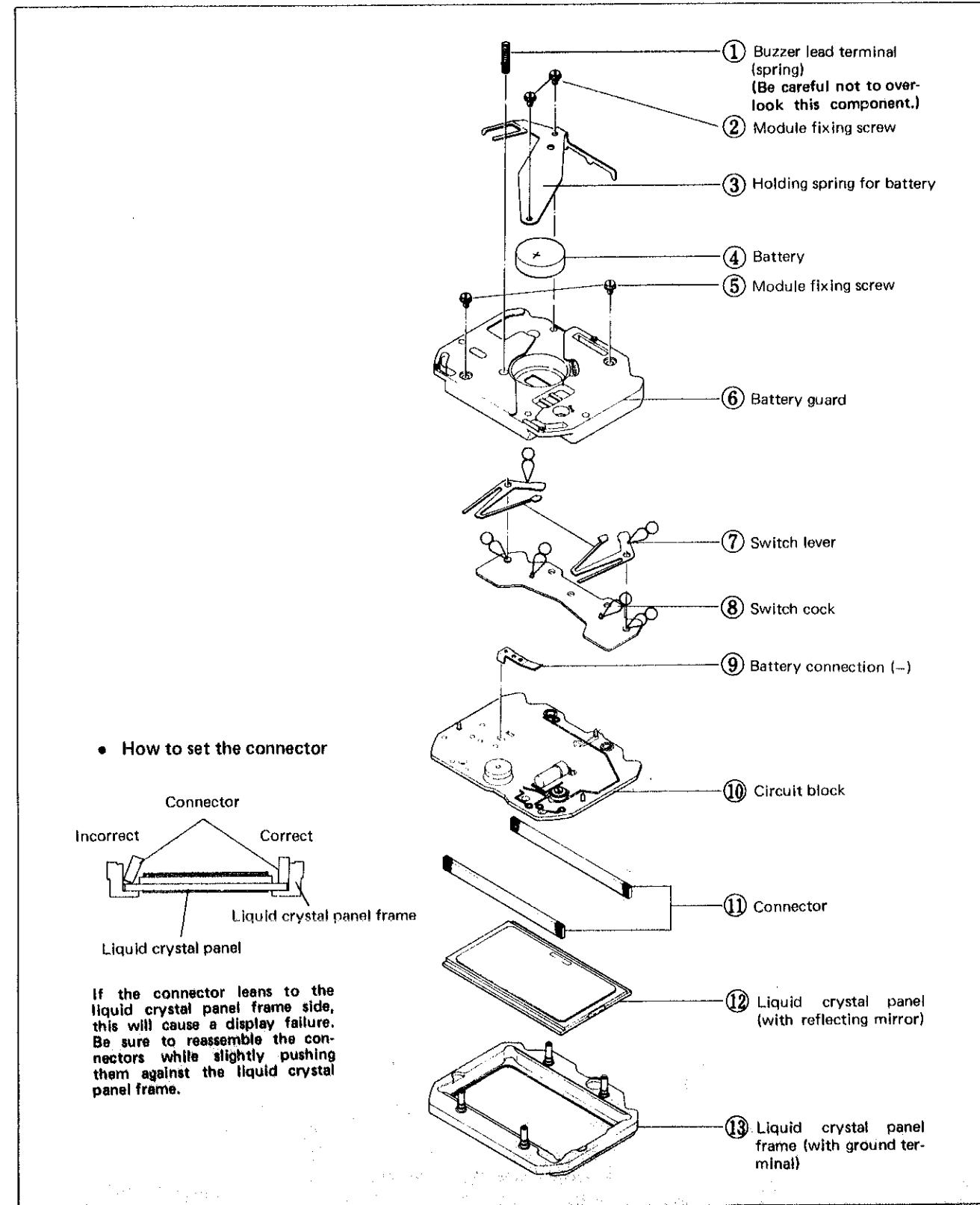

Remarks for disassembling and reassembling

③ Holding spring for battery

- Reassemble the holding spring for battery as shown in the illustration on the right. Be careful not to deform the bent portion (arrow-marked) of the holding spring for battery.
- Tighten the screws ① and then ② after making sure that the holding spring for battery isn't on the switch cock.

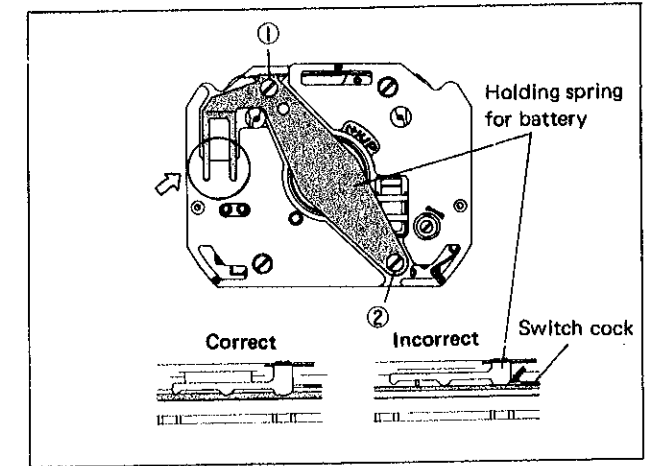

⑦ Switch lever

- Reassemble the switch lever on the switch cock as shown in the illustration on the switch cock.

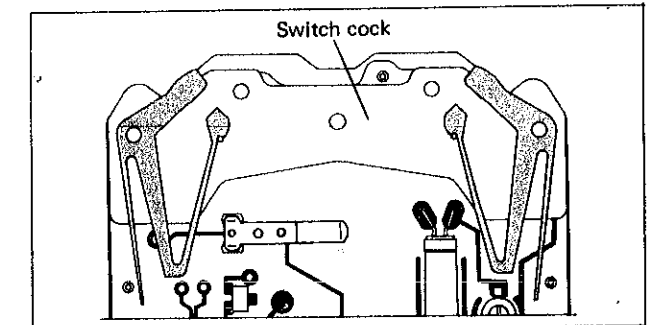

⑨ Battery connection (-)

- Reassemble the minus terminal of battery connection correctly on the electrode of circuit block for minus terminal of battery connection. If the minus terminal of battery connection is reassembled in the incorrect position, it is impossible to reassemble the battery guard correctly.

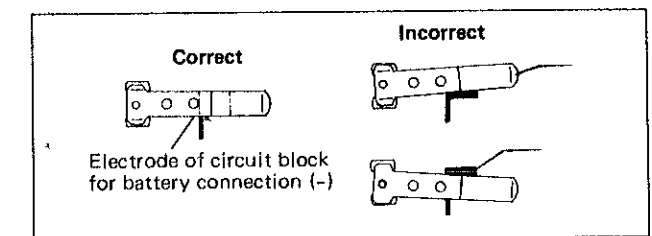

⑩ Circuit block

- When handling the circuit block, be careful not to deform the three pieces of switch pins (arrow-marked).
- Be careful not to cut the lead wire of the upper converter coil.

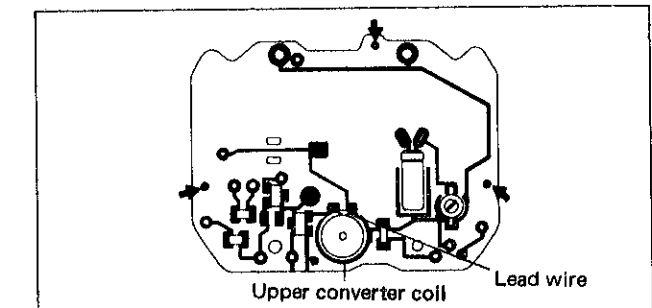

⑫ Liquid crystal panel

- With the parts number side of the liquid crystal panel opposite you or the liquid crystal seal position on the right, set the liquid crystal panel in the liquid crystal panel frame.

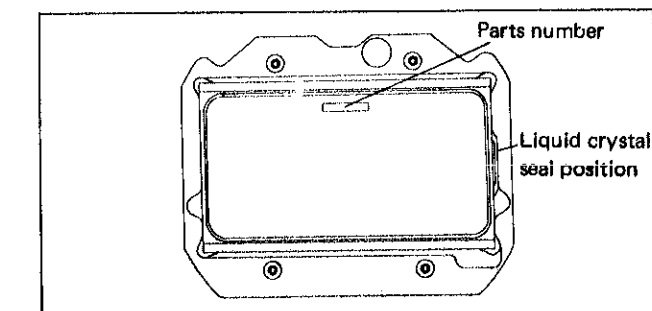

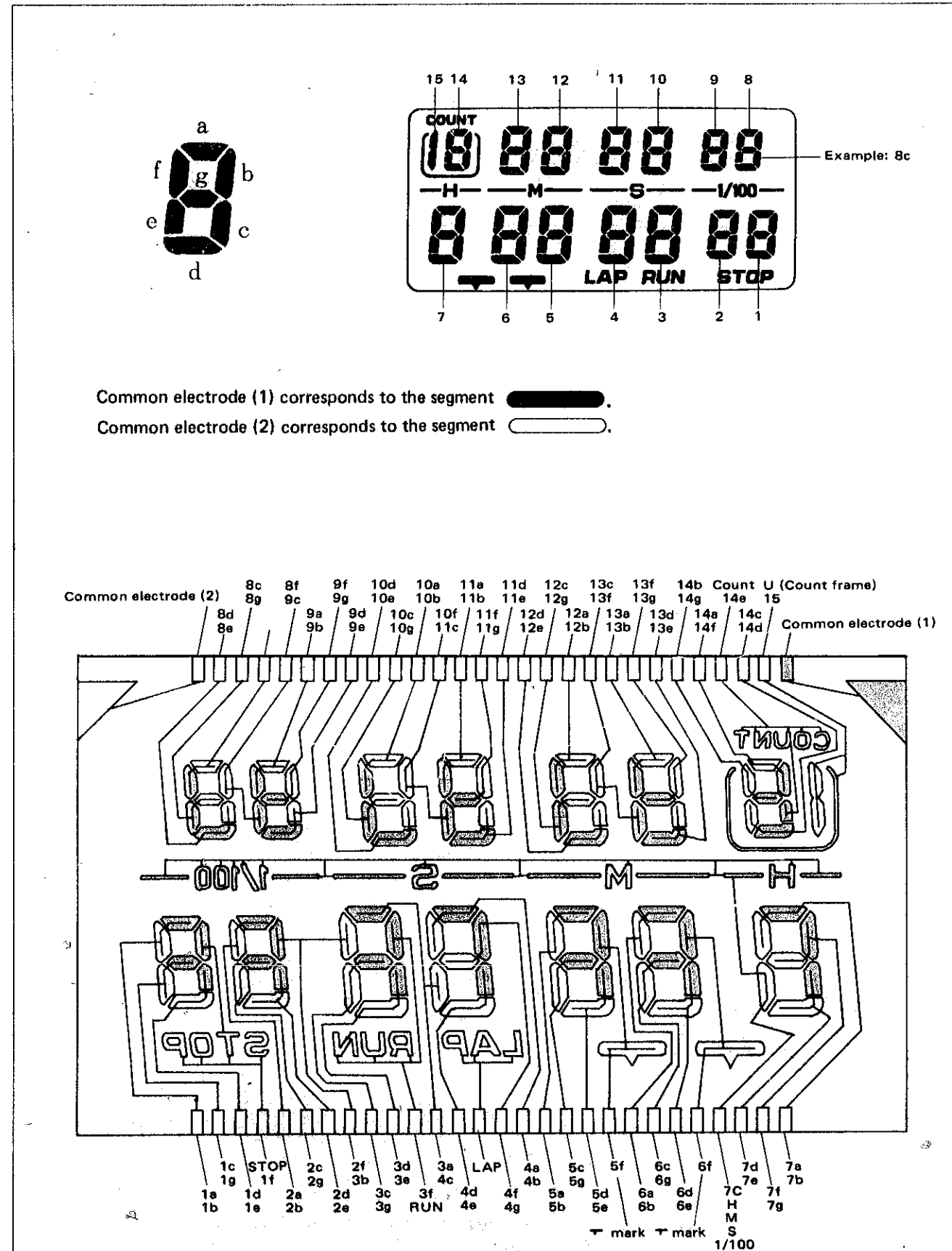

2. Designation of the segment electrode of liquid crystal panel

• Designation of segment

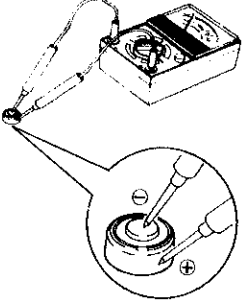

3. Procedures for checking and adjustment

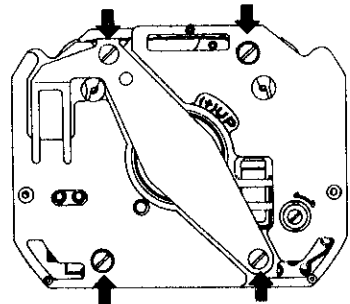
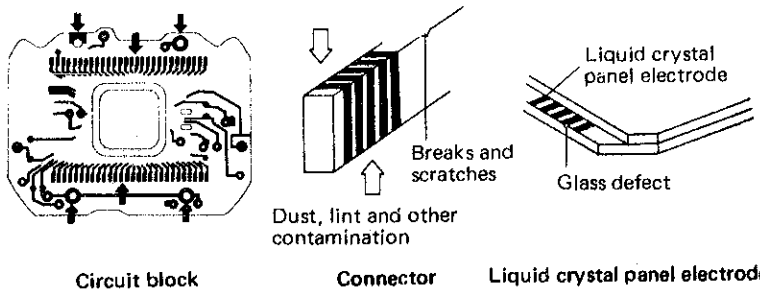
	Procedure	Result and repair
CHECK BATTERY VOLTAGE	<p>Use the following procedures to check battery voltage.</p> <ul style="list-style-type: none"> Set up the Volt-ohm-meter. Range to be used: DC3V Measuring Probe Red (+): Battery surface (+) Probe Black (-): Battery surface (-) 	<p>More than 1.5V: Normal Less than 1.5V: Defective Replace the battery.</p>
CHECK PATTERN SEGMENT CHECKING SYSTEM	<p>Check for any defective segments. With the stopwatch display in the reset condition, depress and hold button (B) for 3 to 4 seconds. All segment should light up and the dead segments are defective.</p> <p>(Depress and hold button (B) for 3 to 4 seconds to display all segments, and the daily rate can be measured readily.)</p>  <p>To return to the reset condition of the stopwatch display, depress either button "A" or "B".</p>	<p>One segment is not displayed: Proceed to Replace the liquid crystal panel.</p> <p>Two or more segments are not displayed: Proceed to B.</p>
CHECK CONDUCTIVITY OF LIQUID CRYSTAL PANEL, CIRCUIT BLOCK AND CONNECTOR	<p>(1) Check for any loosened screws.</p>  <p>(2) Check for dust, lint and other contamination, breaks and cracks and scratches of the connecting portion.</p> 	<p>No loosened screws: Normal Proceed to B (2).</p> <p>Loosened screws: Defective Retighten screws.</p> <p>No dust, lint or uncontaminated: Normal Dust, lint or contaminated: Defective Wipe off any foreign matter.</p> <p>No break, crack or scratch: Normal Broken, cracked or scratched: Defective Replace with new ones.</p>

Procedure

(1) Check to see if the electric signal flows from the circuit block correctly.

1. Set up the circuit block.

Attach the current supplier (S-833) to the circuit block.
 (+): Electrode in the screw hole of the circuit block
 (-): Minus electrode of the circuit block
 (See illustration below.)

2. Set up the Volt-ohm-meter.

Range to be used: DC3V
 Probe Red (+): Electrode in the screw hole of the circuit block
 Probe Black(-): Each portion of the output terminal of the circuit block

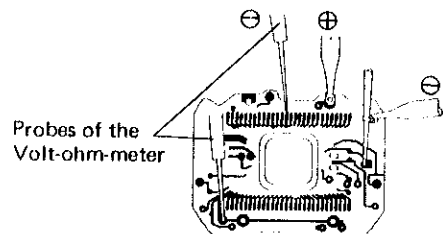

(Put a probe in the minus electrode hole and grasp the probe with an IC clip as shown in the illustration.)

(Measurement is being taken with the current supplier set up and the probes of the Volt-ohm-meter applied.)

(2) Check for any broken panel pattern and short circuit of the liquid crystal panel.

1. Set up the Volt-ohm-meter.

Range to be used: OHMS R x 1
 (Any range will do if more than 3V is applied.)

2. Apply the probes to the common electrode and the segment electrode of the liquid crystal panel.
 (Either red or black probe will do.)

Common electrode (2) Common electrode (1)

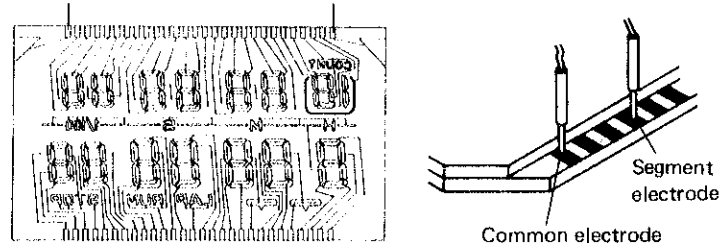

• The liquid crystal panel is provided with two common electrodes. Each segment shows up black by the potential difference between each segment and one of these two common electrodes.

• For the combination of each segment and common electrodes ① and ②, see the illustration on page 10.

Result and repair

More than 0.8V: Normal
 Less than 0.8V: Defective

(If some displays are defective, apply the probes to the corresponding output terminals of the circuit block.)

Lights up: Normal
 Does not light up: Defective
 Replace the liquid crystal panel.

Procedure

• Check to see if the current consumption is normal.

• When the Volt-ohm-meter is used.
 Range to be used: DC12μA (DC 0.03mA)
 Probe Red (+): Battery connection (-)
 Probe Black (-): Battery surface (-)
 The illustration shows how to apply the probes.

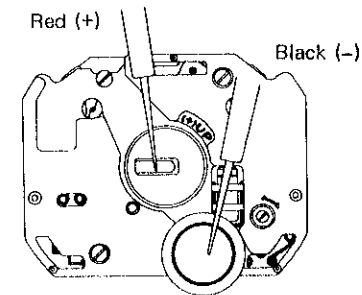

Put the battery on the module fixing screw with its minus surface down.

• When the alarm does not ring

- ① Power switch ON
 - ② Polarity changeover button +
 - ③ Current consumption/Voltage indicator button μA
 - ④ Voltage selection button 1.55V
- Probe Black (-): Battery connection (-)
 Clip Red (+): Module fixing screw

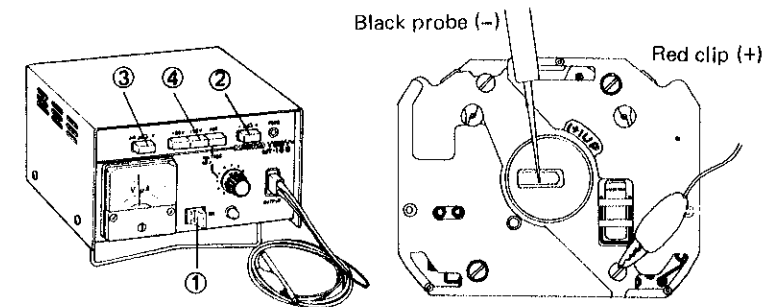

Apply the Red clip (+) to the head of the module fixing screw for measuring.

Result and repair

Less than 3.5μA: Normal
 Replace the battery.
 More than 3.5μA: Defective
 Proceed to ④.

Remarks:
 If the pointer of the Volt-ohm-meter swings over the maximum value while the current consumption is measured, change the range to a greater one (Ex. DC 30mA) where the pointer does not run over the maximum value while applying the probes to the respective portions. Then, after two or three seconds, return the range to DC 12μA or 0.03mA again for measuring.

Remarks:
 If the pointer of the Micro Test swings over the maximum value while the current consumption is measured, depress the Current consumption/Voltage indicator button ③ so that it is released to indicate the voltage (μV) while the black probe and the red clip are applied. Then, after two or three seconds, depress the Current consumption/Voltage indicator button again so that it holds in the pushed-in position (μA) to indicate the current consumption for measuring.

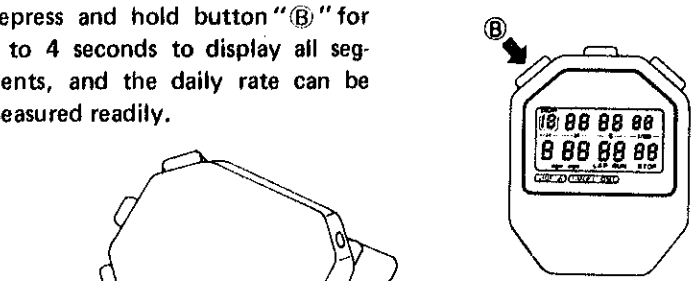
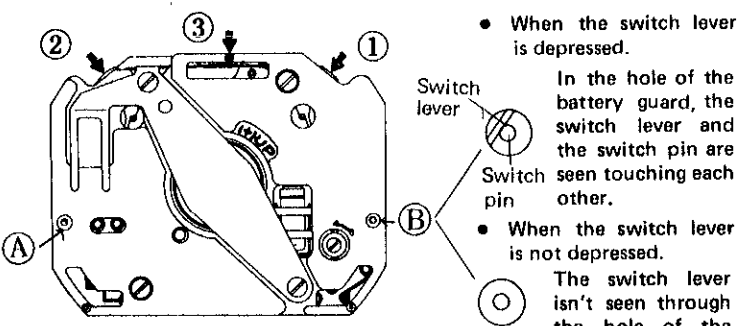
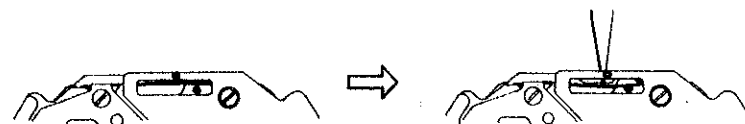
	Procedure	Result and repair
CHECK ACCURACY	<p>Check gain and loss of time. Depress and hold button "B" for 3 to 4 seconds to display all segments, and the daily rate can be measured readily.</p>  <ul style="list-style-type: none"> Place the watch on the microphone so that the display panel portion comes to the center of the microphone. 	<p>Neither gain nor lose: Normal Gain or lose: Defective Proceed to F Time accuracy adjusting. Time accuracy is adjusted by turning the trimmer condenser.</p>
CHECK CONDUCTIVITY OF SWITCH COMPONENTS	<p>Check to see if the switch spring functions correctly.</p> <ul style="list-style-type: none"> Check with the module reassembled.  <ul style="list-style-type: none"> When the switch lever is depressed. In the hole of the battery guard, the switch lever and the switch pin are seen touching each other. When the switch lever is not depressed. The switch lever isn't seen through the hole of the battery guard. <ol style="list-style-type: none"> Through the holes "A" and "B" of the battery guard, check to see if the spring portion of the switch lever touches the switch pin of the circuit block when the switch levers ① and ② are pushed with the tips of tweezers and that the spring portion of the switch lever does not touch the switch pin of the circuit block when the switch lever is released. Check to see if the spring portion ③ of the battery holding spring touches the switch pin when the spring portion is pushed with the tips of tweezers and that the spring portion ③ of the battery holding spring does not touch the switch pin when the spring portion is released.  <ol style="list-style-type: none"> Check for dust, lint and other contamination of the connecting portions. 	<p>Functions correctly: Normal Proceed to F 3. Does not function correctly: Defective If the switch lever, battery guard or switch pin of the circuit block does not function correctly after they are adjusted, replace them with new ones.</p> <p>No dust, lint or uncontaminated: Normal Dust, lint or contaminated: Defective Wipe off any foreign matter.</p>

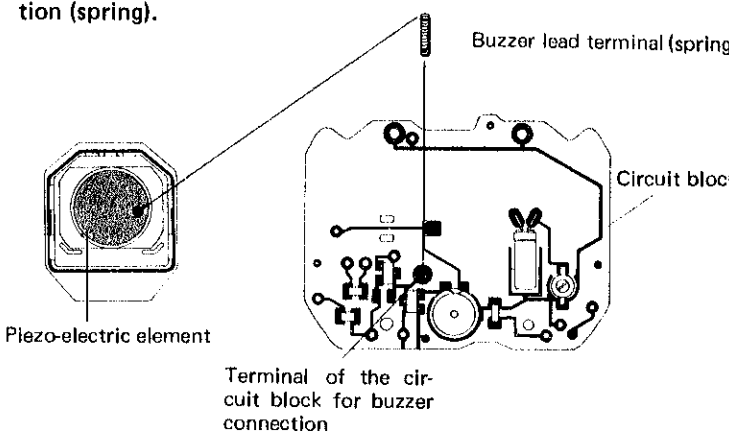
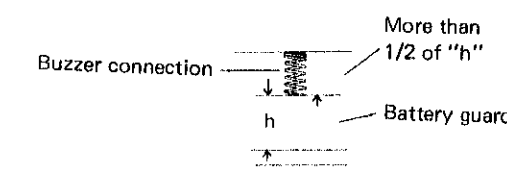
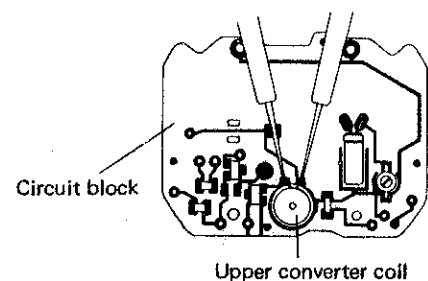
	Procedure	Result and repair
CHECK ALARM CONDITION	<p>Check to see if the alarm (piezo-electric buzzer) rings correctly when an interval timer time is set.</p> <ul style="list-style-type: none"> When the alarm does not ring <ol style="list-style-type: none"> Check for any contamination of the connecting portions of the piezo-electric element on the case back and of the circuit block electrode. Also, check for any deformation of the buzzer connection (spring).  <ul style="list-style-type: none"> Check to see if the alarm rings with the buzzer connection (spring) reassembled. Buzzer connection should project out from the surface of the battery guard by more than 1/2 of the height "h" of the battery guard.  <ol style="list-style-type: none"> Check resistance of the upper converter coil block, and check for any broken coil wire or short-circuit. <ul style="list-style-type: none"> Set up the Volt-ohm-meter. Range to be used: OHMS R x 1 Measuring Apply the probes of the Volt-ohm-meter to the soldered portion of the wire terminal of the upper converter coil. (Either red or black probe will do.) 	<p>Uncontaminated or not deformed: Normal Contaminated: Defective Wipe off any foreign matter. Deformed: Defective Correct the deformation with tweezers.</p> <p>More than 1/2 of the height of the battery guard: Normal Less than 1/2 of the height of the battery guard: Defective Correct with tweezers. Be careful not to lengthen the spring to much.</p> <p>Resistance 40Ω ~ 60Ω: Normal Less than 40Ω (short-circuit) or more than 60Ω (broken coil wire): Defective Replace the circuit block with a new one.</p>

I

Procedure

Result and repair

Check functioning and adjustment by operating the buttons after reassembling the case.

1. Check changeover of display.
Check to see if changeover to and from the stopwatch display and the interval timer display is made correctly by depressing button "C".
2. Check adjustment of display.
Check to see if the button operation and adjustment correspond correctly in all time adjusting functions.
 - Check the watch in all time adjusting functions through more than one round of functioning.
3. Check the alarm.
By depressing each button, check to see if the alarm rings to indicate that the button is depressed. Also, check to see if the alarm rings correctly at the interval timer time set.
The alarm differs depending on the set time interval.

Set Time Interval	Alarm
• Within 1 minute	It rings one time.
• From 1 minute to 10	It rings three times.
• Over 10 minutes	It rings ten times.

Function correctly and can be adjusted: Normal
 Proceed to **B**
 Does not function correctly or cannot be adjusted: Defective
 Replace the circuit block.

All procedures of Disassembling, Reassembling, Checking and Adjustment are completed.