

SEIKO

DIGITAL QUARTZ

Cal. C439A

PARTS LIST

Cal. C439A

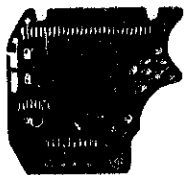
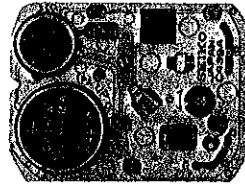

4001 238



4216 235



4224 232



4270 234



4271 231



4293 230



4313 236



4313 237



4313 238



4398 116

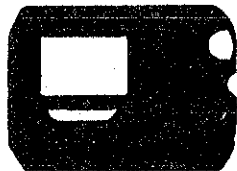

4398 117



4398 118

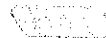

4398 119



4398 121

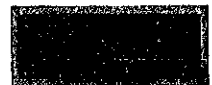

4510 391



4521 233



4530 230



4540 237



4540 238



4580 242



4991 237



☆ Toshiba SR1130W



012 462



017 249



017 251



Cal. C439A

Characteristics

Casing diameter: 21.9 mm×30.0 mm
 Maximum height: 5.3 mm without battery
 Frequency of quartz crystal oscillator: 32,768 Hz (Hz=Hertz Cycles per second)
 Time and calendar display: Hour (12 hour indication), minute, second, and day of the week. At the push of button, year, month, date and day of the week.
 Calculator display: Arithmetic operations and calculation up to 8 digits.
 Alarm display: Can be set to operate at any desired hour and minute in 5 kinds of alarm time.
 Stopwatch display: Hour, minute, second, and 1/10 second up to 12 hours.
 Regulation system: Trimmer condenser.
 Display medium: Nematic Liquid crystal, FE-Mode.
 Time signal: It can be set to ring every hour on the hour.
 Illuminating light: Illuminates the display in the dark.
 Battery life indicator: All the digits in the display begin flashing.

PART NO.	PART NAME	PART NO.	PART NAME
4001 238	Circuit block		
4216 235	Insulator for keyboard		
4224 232	Keyboard plate		
4270 234	Battery connection (-)		
4271 231	Battery connection (+)		
4293 230	Keyboard switch plate		
4313 236	Connector (A)		
4313 237	Connector (B)		
4313 238	Connector (C)		
4398 116	Battery guard		
4398 117	Liquid crystal panel frame		
4398 118	Keyboard switch plate holder (A)		
4398 119	Keyboard switch plate holder (B)		
4398 121	Speaker frame		
4510 391	Liquid crystal panel		
4521 233	Reflecting mirror		
4530 230	Bulb		
4540 237	Liquid crystal panel holder (A)		
4540 238	Liquid crystal panel holder (B)		
4580 242	Speaker block		
4991 237	Speaker gasket		
012 462	Liquid crystal panel holder screw		
012 462	Keyboard plate screw		
012 462	Battery connection (+) screw		
017 249	Tube for liquid crystal panel holder screw		
017 249	Tube for keyboard plate screw		
017 251	Tube for battery connection (+) screw		
☆Toshiba SR1130W ☆Toshiba WG10 ☆U.C.C.389 ☆Maxell SR1130W	Silver oxide battery		

Remarks :

Battery

- ☆Toshiba SR1130W
- ☆Toshiba WG10
- ☆U.C.C.389
- ☆Maxell SR1130W

} The substitutive battery might be added to the applied battery in the future.
 }.....In that case, please refer to separate "BATTERY LIST FOR SEIKO
QUARTZ WATCHES."

TECHNICAL GUIDE

SEIKO DIGITAL QUARTZ

CAL. C 439A

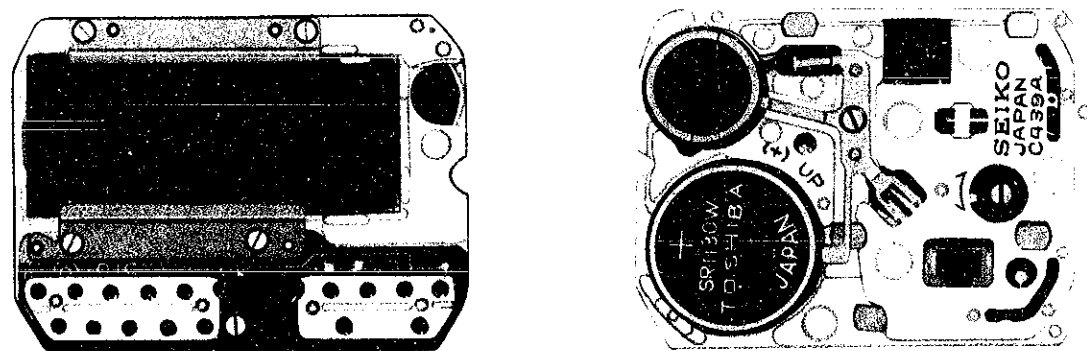

CONTENTS

I. SPECIFICATIONS	1
II. STRUCTURE OF THE CIRCUIT BLOCK	1
III. DISASSEMBLING, REASSEMBLING AND LUBRICATING OF THE CASE	2
IV. DISASSEMBLING AND REASSEMBLING OF THE MODULE	3
1. Battery side	3
2. Liquid crystal panel side	4
3. Segment (Liquid crystal panel electrode)	5
V. CHECKING AND ADJUSTMENT	6
• Check battery voltage	6
• Check pattern segment checking system	6
• Check conductivity of liquid crystal panel, circuit block, connector, keyboard plate and keyboard switch plate	6
• Check liquid crystal panel and circuit block	6
• Check current consumption	7
• Check speaker block	8
• Check accuracy	8
• Check functioning and adjustment	8

I. SPECIFICATIONS

Cal. No.	C439A
Item	
Display medium	Nematic Liquid Crystal, FEM (Field Effect Mode)
Liquid crystal driving system	Multiplex driving system
Display system	<ul style="list-style-type: none"> • Time and calendar function (Year, month, date and day of the week while depressing button B.) • Alarm function (The alarm can be set for 5 different alarm times.) • Stopwatch function • Calculator function: Addition, subtraction, multiplication, division, mixed calculation, constant calculation, raising numbers to a power, reciprocals, and overflow calculation
Additional mechanism	<ul style="list-style-type: none"> • Time signal • Illuminating light • Alarm test system • Battery life indicator
Loss/gain	Loss/gain at normal temperature range Mean monthly rate : less than 15 seconds (Annual rate : less than 3 minutes)
Outside diameter	21.9 mm between 6 o'clock and 12 o'clock sides 30.0 mm between 3 o'clock and 9 o'clock sides
Height	5.3 mm without battery
Regulation system	Trimmer condenser
Measuring gate by Quartz Tester	Any gate is available (with all segments displayed).
Battery	U.C.C. 389, Maxell SR1130W, Toshiba SR1130W (or Toshiba WG-10) Battery life is approximately 2 years. Voltage: 1.55V

II. STRUCTURE OF THE CIRCUIT BLOCK

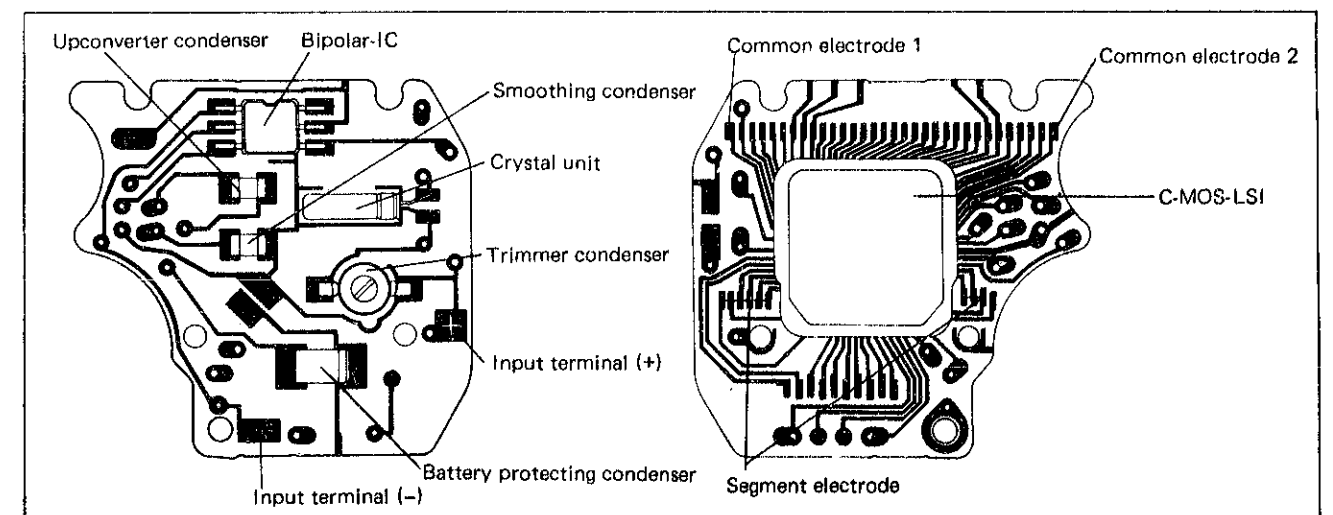

III. DISASSEMBLING, REASSEMBLING AND LUBRICATING OF THE CASE

Ex.) For the Case No. C439-5000

- Disassembling procedures Figs.: ① → ⑥
- Reassembling procedures Figs.: ⑥ → ①

- Lubricating
Silicone grease 500,000 c.s. 

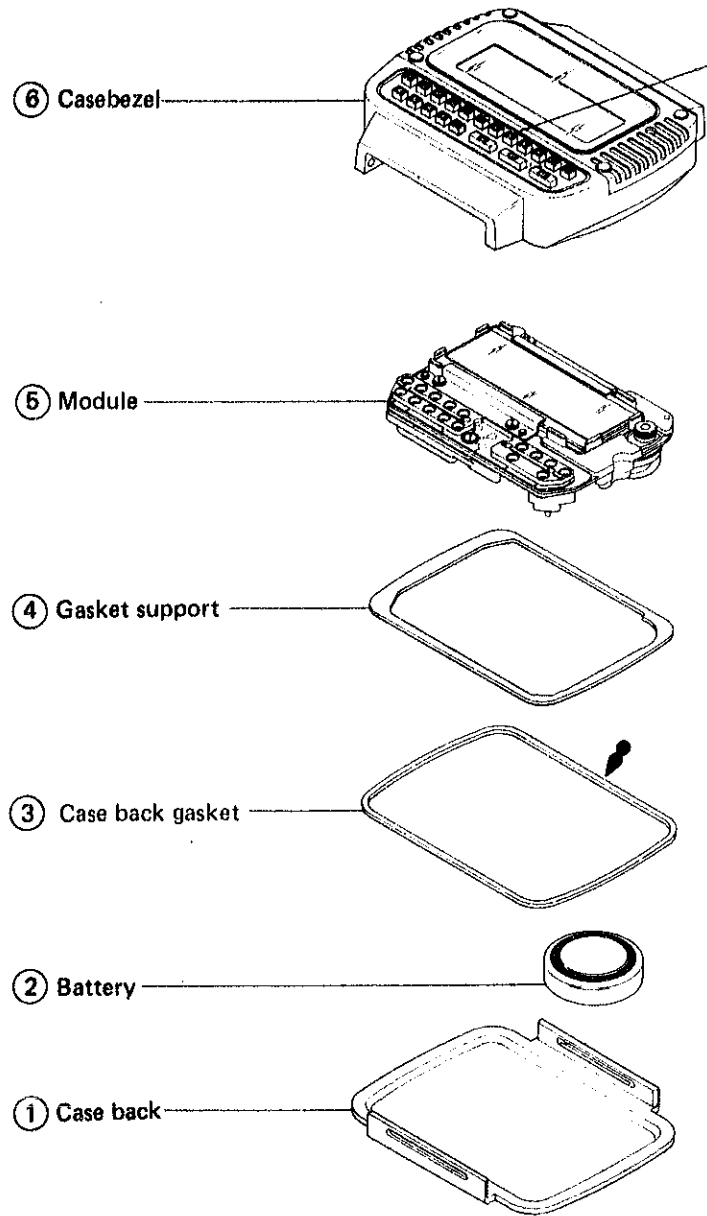

Disassembling and reassembling of the keyboard portion (It is not necessary to disassemble them except when the parts are required to be replaced.)

- How to disassemble
Push the keyboard frame from inside the casebezel with the tail of tweezers as shown in the illustration and remove it.

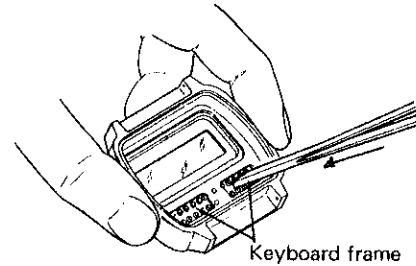

- How to reassemble
1) Turn the keyboard over and set the keys (17 pcs.) and buttons (3 pcs.) in the keyboard.

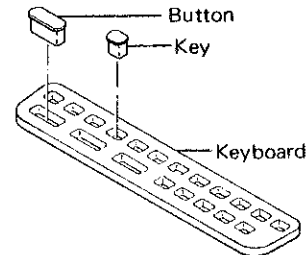

- 2) Put the keyboard frame on the keyboard (with the keys and buttons) and turn it over.
- 3) Reassemble the keyboard portion. Set the keyboard unit with the finger as shown in the illustration.

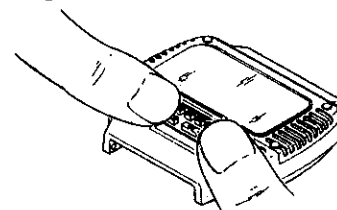

- How to remove the case back
Put the tip of the case opener into the fastening projections of the case back at 12 and 6 o'clock sides and pry it up. In this case, be careful not to use the case lug as a fulcrum.

Note:

- Be careful not to pry up the casebezel except at 12 and 6 o'clock sides.
- After having reassembled the case back, check to see if the case back gasket is set correctly.

Note:

- Be careful that the keyboard is not lifted-out of position.

IV. DISASSEMBLING AND REASSEMBLING OF THE MODULE

Disassembling procedures Figs.: ① → ⑳

Reassembling procedures Figs.: ㉑ → ①

1. Battery side

- Setting position of battery connection (+)

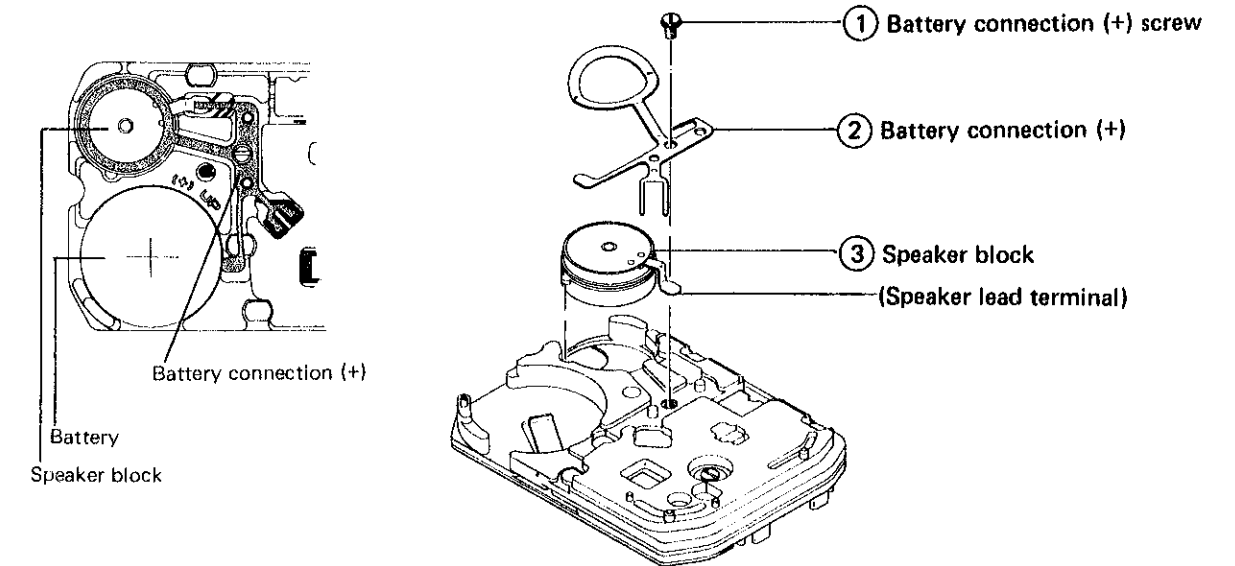

- Speaker lead terminal
When reassembling, hold the speaker lead terminal between the battery connection (+) and the circuit block and bend it. (See the illustration on the right.)

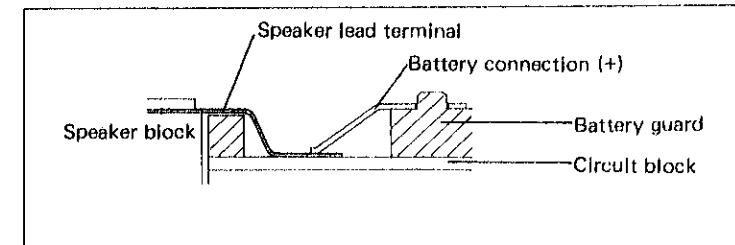

- Speaker block
It is not necessary to disassemble the speaker block generally. In case a part is off the speaker frame, reset the speaker block in the order shown on the right so that dust may not enter the inside of the speaker block.

Note:

- Be careful not to deform the vibrating plate and the sound diaphragm, as the alarm may vary in tone and volume.

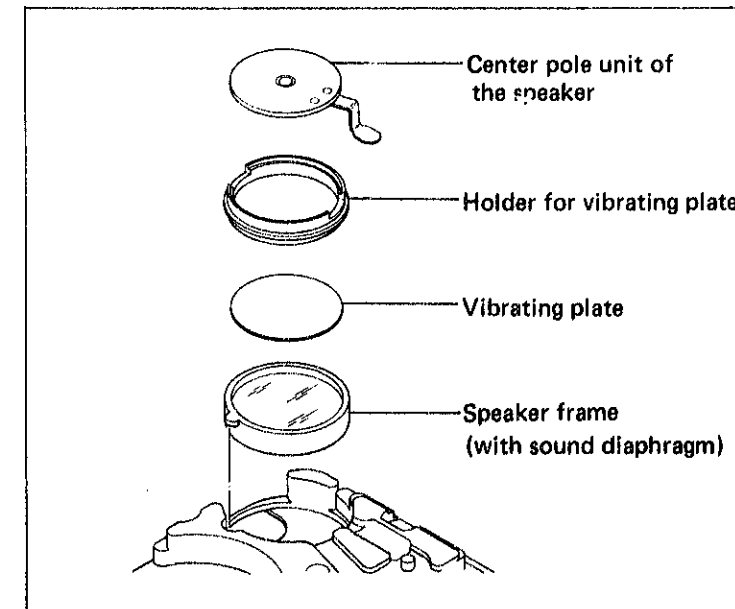

2. Liquid crystal panel side

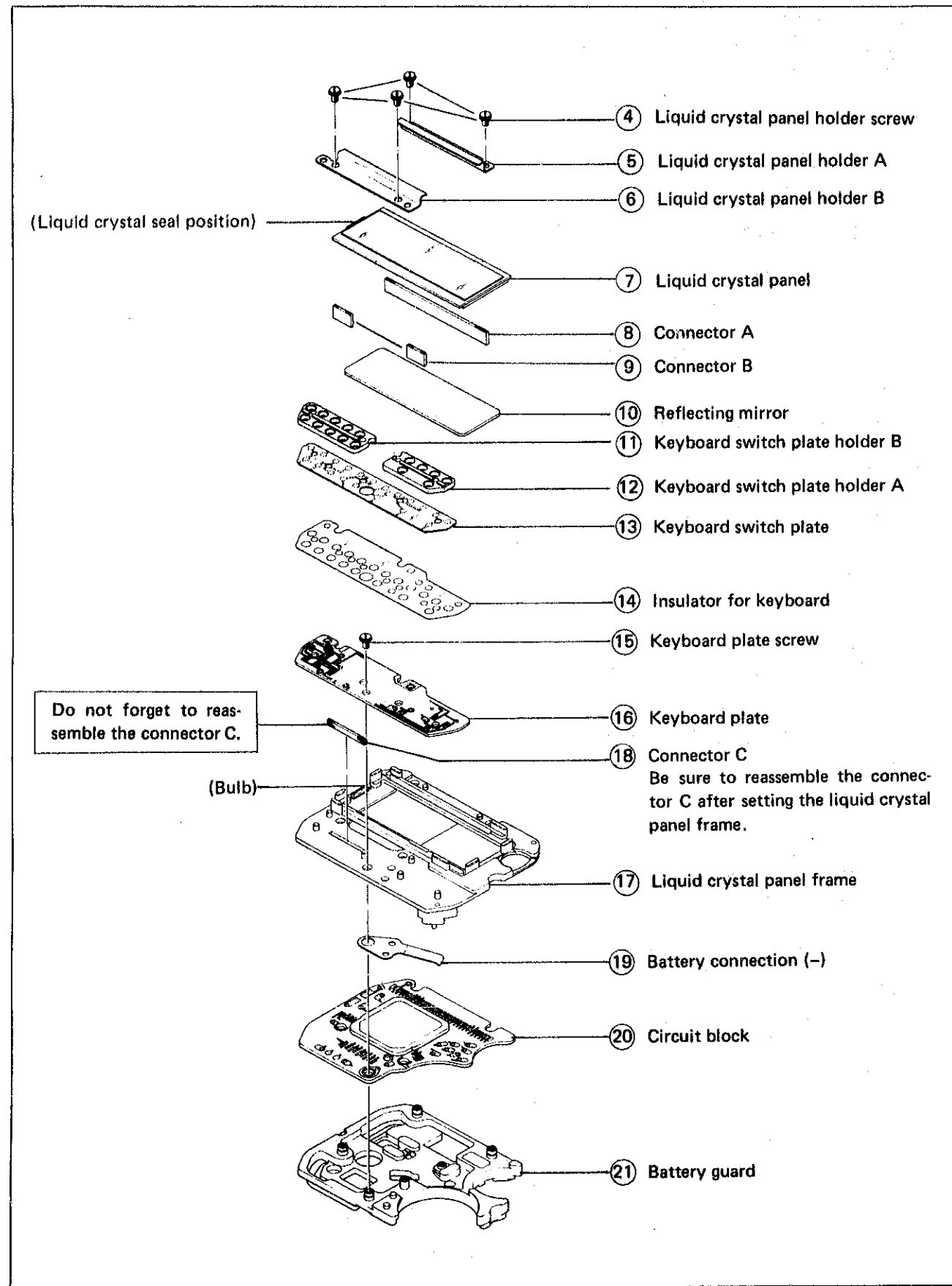

3. Segment (Liquid Crystal Panel Electrode)

• Designation of segment

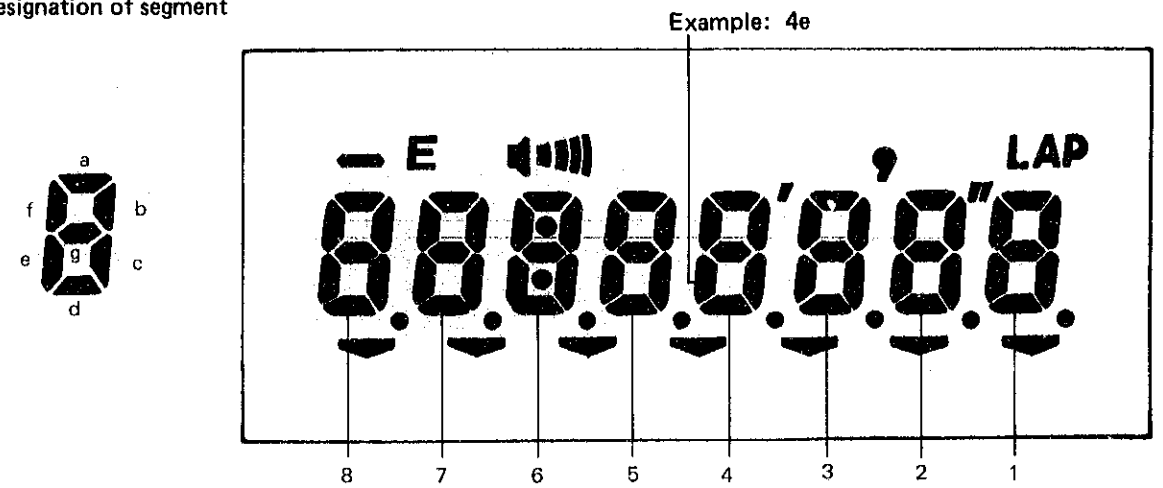

Common electrode 1 (connected electrically with segments)

Common electrode 2 (connected electrically with segments)

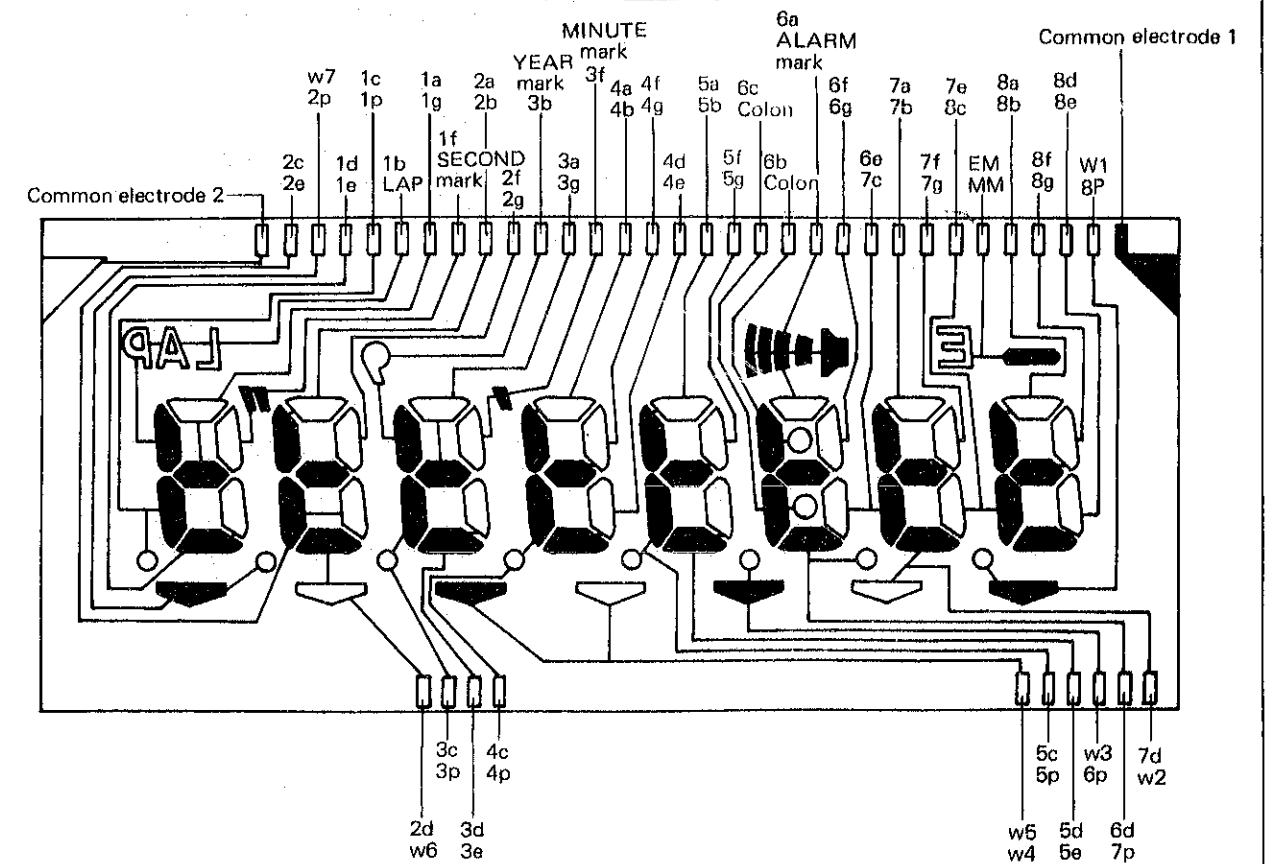

Marks:
W : DAY mark
EM : ERROR mark
MM : MINUS mark
P : DECIMAL POINT mark

V. CHECKING AND ADJUSTMENT

- Refer to the "SEIKO QUARTZ TECHNICAL GUIDE, GENERAL INSTRUCTION" for Digital Watches for details.

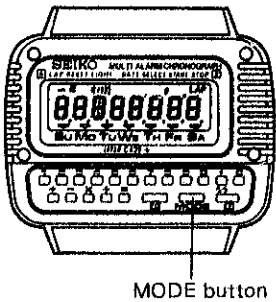
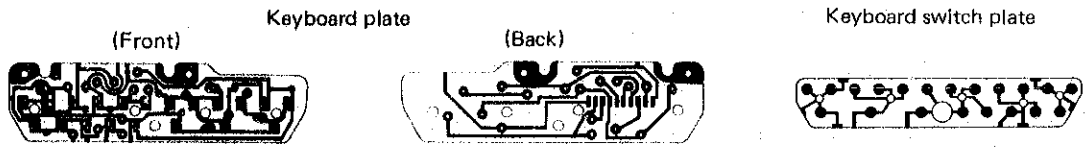
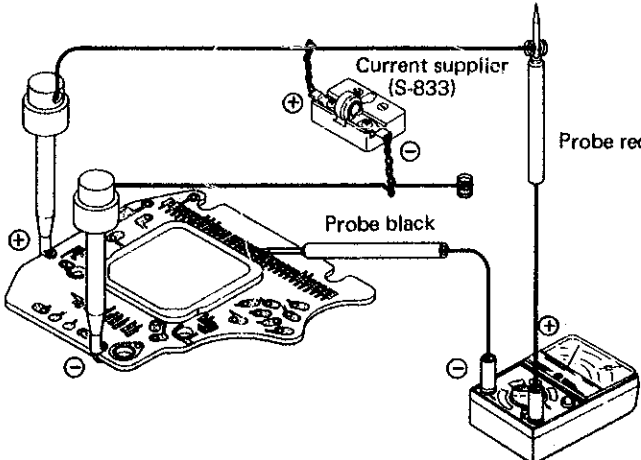
Procedure	
CHECK BATTERY VOLTAGE	<p>Result: More than 1.5V: Normal Less than 1.5V: Defective</p>
CHECK PATTERN SEGMENT CHECKING SYSTEM	
 <p>MODE button</p>	<ul style="list-style-type: none"> Depress the MODE button for 3 to 4 seconds continuously, and all the segments light up. Check to see if there are any defective segments with all the segments lit.
CHECK CONDUCTIVITY OF LIQUID CRYSTAL PANEL, CIRCUIT BLOCK, CONNECTOR, KEYBOARD PLATE AND KEYBOARD SWITCH PLATE	
<ul style="list-style-type: none"> Check to see if there are any dust, lint and contamination on the conductive portions. 	
 <p>(Front) Keyboard plate (Back) Keyboard switch plate</p>	
<p>If there is any contamination on the keyboard plate, clean it away by the same cleaning method as for the circuit block.</p>	
CHECK LIQUID CRYSTAL PANEL AND CIRCUIT BLOCK	
<ul style="list-style-type: none"> Check the output voltage for the circuit block. (Liquid crystal panel electrode: connected portions with the connector A, B) 	
 <p>Current supplier (S-833) Probe red Probe black</p>	<p>Result: More than 0.8V: Normal Less than 0.8V: Defective</p>

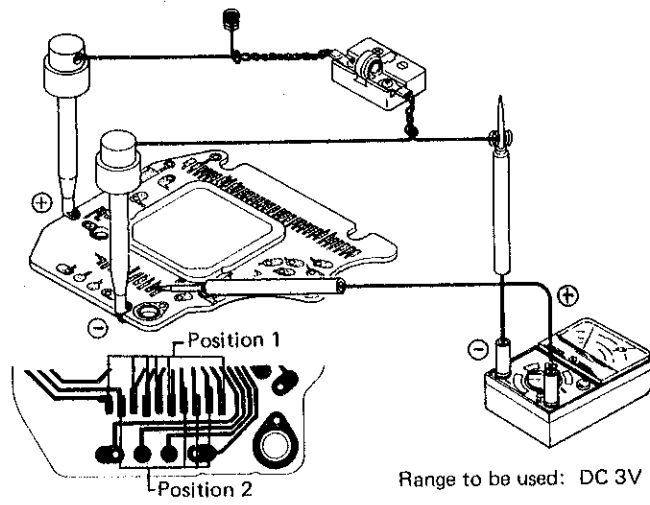
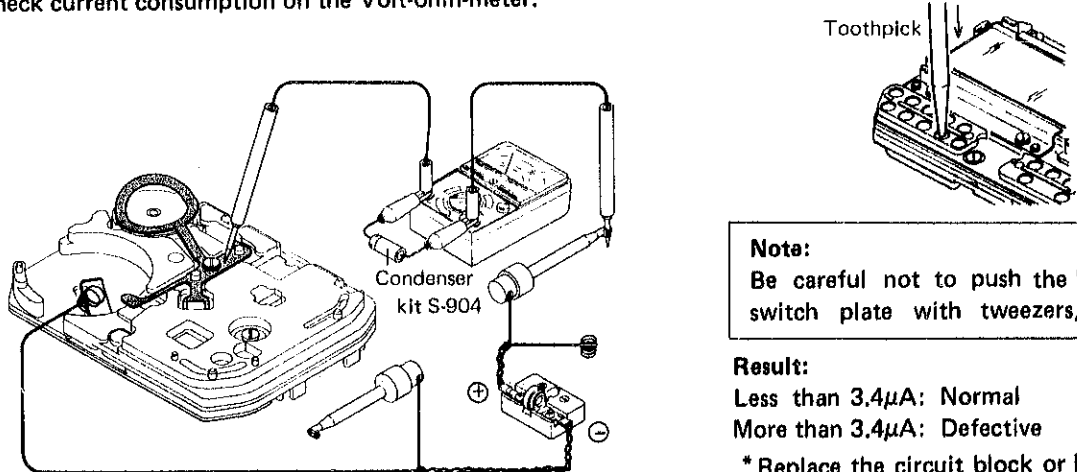
Procedure		
(Keyboard plate electrode: connected portion with the connector C)		
 <p>Position 1 Position 2 Range to be used: DC 3V</p>	<ul style="list-style-type: none"> Apply the probe to each terminal of "Position 1". (6 places) Result: Pointer of the Volt-ohm-meter swings: Normal Pointer of the Volt-ohm-meter does not swing: Defective Apply the probe to each terminal of "Position 2". (4 places) Result: Pointer of the Volt-ohm-meter does not swing: Normal Pointer of the Volt-ohm-meter swings: Defective 	
<ul style="list-style-type: none"> Checking the liquid crystal panel 		<p>Result: Lights up : Normal Does not light up: Defective</p>
CHECK CURRENT CONSUMPTION		
<p>When current is supplied to the liquid crystal panel, all the segments are lit, which indicates a high value of current consumption. So, push the keyboard switch plate with a toothpick, etc. to activate the time display and check current consumption on the Volt-ohm-meter.</p>		
 <p>Condenser kit S-904 Toothpick</p>	<p>Note: Be careful not to push the keyboard switch plate with tweezers, etc.</p> <p>Result: Less than 3.4μA: Normal More than 3.4μA: Defective * Replace the circuit block or liquid crystal panel with a new one.</p>	
<p>*How to check if the liquid crystal panel or the circuit block is defective when the current consumption is more than 3.4μA.</p> <p>Disassemble the liquid crystal panel, reflecting mirror, connectors A and B from the module and check the current consumption. (Be sure to push the keyboard switch plate before measuring.)</p>		<p>Result: Less than 2.9μA: Normal Replace the liquid crystal panel with a new one. More than 2.9μA: Defective Replace the circuit block with a new one.</p>
<p>Note: Since a special IC is used, the pointer of the Volt-ohm-meter will swing unstably in measuring. Be sure to connect the condenser kit (S-904) to the Volt-ohm-meter as shown in the illustration or read a mean value on the Volt-ohm-meter.</p>		

Procedure

CHECK SPEAKER BLOCK

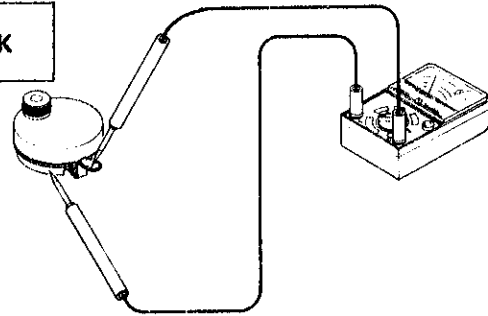

Result:
 120Ω ~ 140Ω : Normal
 Less than 120Ω (Short circuit) — Defective
 More than 140Ω (Broken wire)

CHECK ACCURACY

- Depress the MODE button for 3 to 4 seconds, and all the segments light up. That facilitates measuring the daily rate.

CHECK FUNCTIONING AND ADJUSTMENT

- Check to see if the display changes in the order below from the time display.

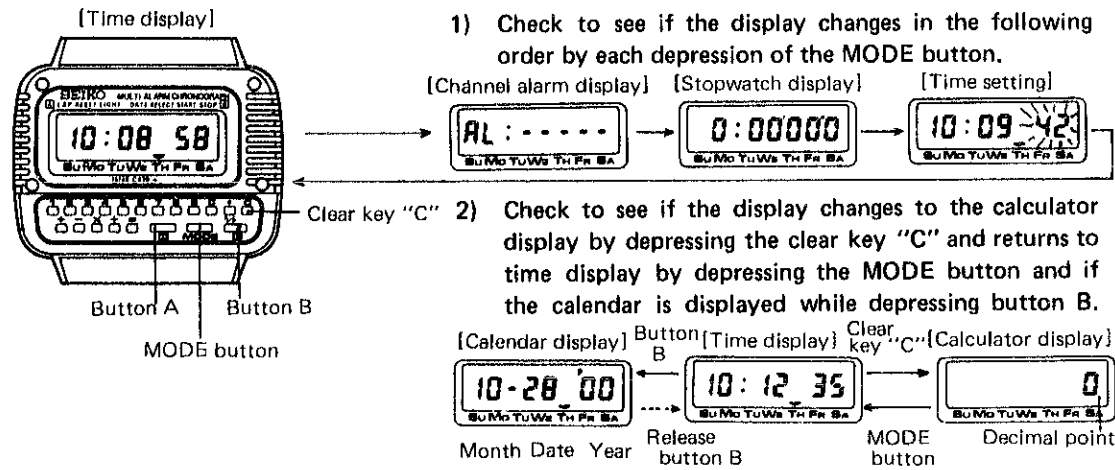

- Check of the functioning of each display
 Check to see if the time can be set and adjusted correctly and the stopwatch and alarm setting function properly.

[Alarm setting]

From the channel alarm display, check to see if the desired channel is displayed by depressing each number key "1" ~ "5". Next depress the button "B" and check to see if the digits to be adjusted change from hour digits to minute digits and check to see if the time can be set by depressing the number keys and A/P key.

[Stopwatch functioning]

From the stopwatch display, check to see if the stopwatch function can be activated by depressing the buttons "A" and "B".

[Time and calendar setting]

Check to see if the digits to be adjusted change in the following order by each depression of the button "B" from the time setting function and they can be adjusted by depressing the number keys.

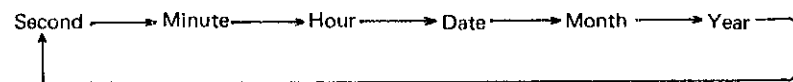

(The day of the week is automatically adjusted with the setting of the year, month, and date.)

[Calculator functioning]

Check to see if each calculation can be performed by depressing the operation keys and if the error mark "E" is displayed when the calculation result exceeds 8 digits or the calculation is impossible and if the mark can be cleared by the clear key "C".

All procedures of Disassembling, Reassembling, Checking and Adjustment are completed.