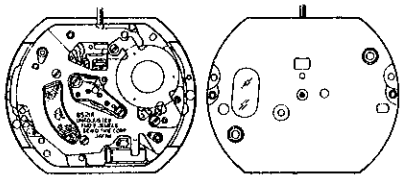
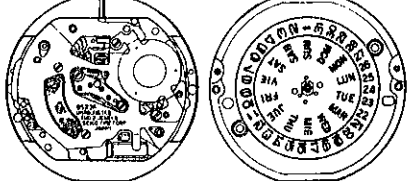

PARTS CATALOGUE/TECHNICAL GUIDE

Cal. 8S21A

Cal. 8S23A

[SPECIFICATIONS]

Item		Cal. No.	8S21A	8S23A
Movement				
Movement size	Outside diameter		24.0 mm between 3 o'clock and 9 o'clock sides 29.5 mm between 6 o'clock and 12 o'clock sides	22.0 mm between 3 o'clock and 9 o'clock sides 29.3 mm between 6 o'clock and 12 o'clock sides
	Casing diameter		φ26.0 mm	
	Height		2.9 mm	3.0 mm
Time indication			3 hands	
Driving system			Step motor (Load compensated driving pulse type)	
Additional mechanism			Quick start function	
			Remaining power check function	
			Power depletion warning function	
			Electronic circuit reset switch	
			Train wheel setting device	
			—	Day and date
	—	Instant calendar setting device		
Loss/gain			Monthly rate at normal temperature range: less than 15 seconds	
Regulation system			Nil	
Measuring gate by quartz tester			Use 10-second gate.	
Power supply	Solar cell		Amorphous solar cell	
	Capacitor		Matsushita EECW 2R4E 334	
Operating voltage range			Capacitor voltage: 1.05 ~ 2.40V	
Expected life per charge			From full charge to stoppage: 120 hours on an average From the start of the second hand's 2-second step movement to stoppage: Approx. 15 hours	
Jewels			2 jewels	

PARTS CATALOGUE

Cal. 8S23A

Disassembling procedures Figs.: ① → ⑤③
 Reassembling procedures Figs.: ⑤③ → ①

Lubricating: Types of Oil quantity

● Moebius A ◌ Normal quantity
 ◌ SEIKO Watch Oil S-6



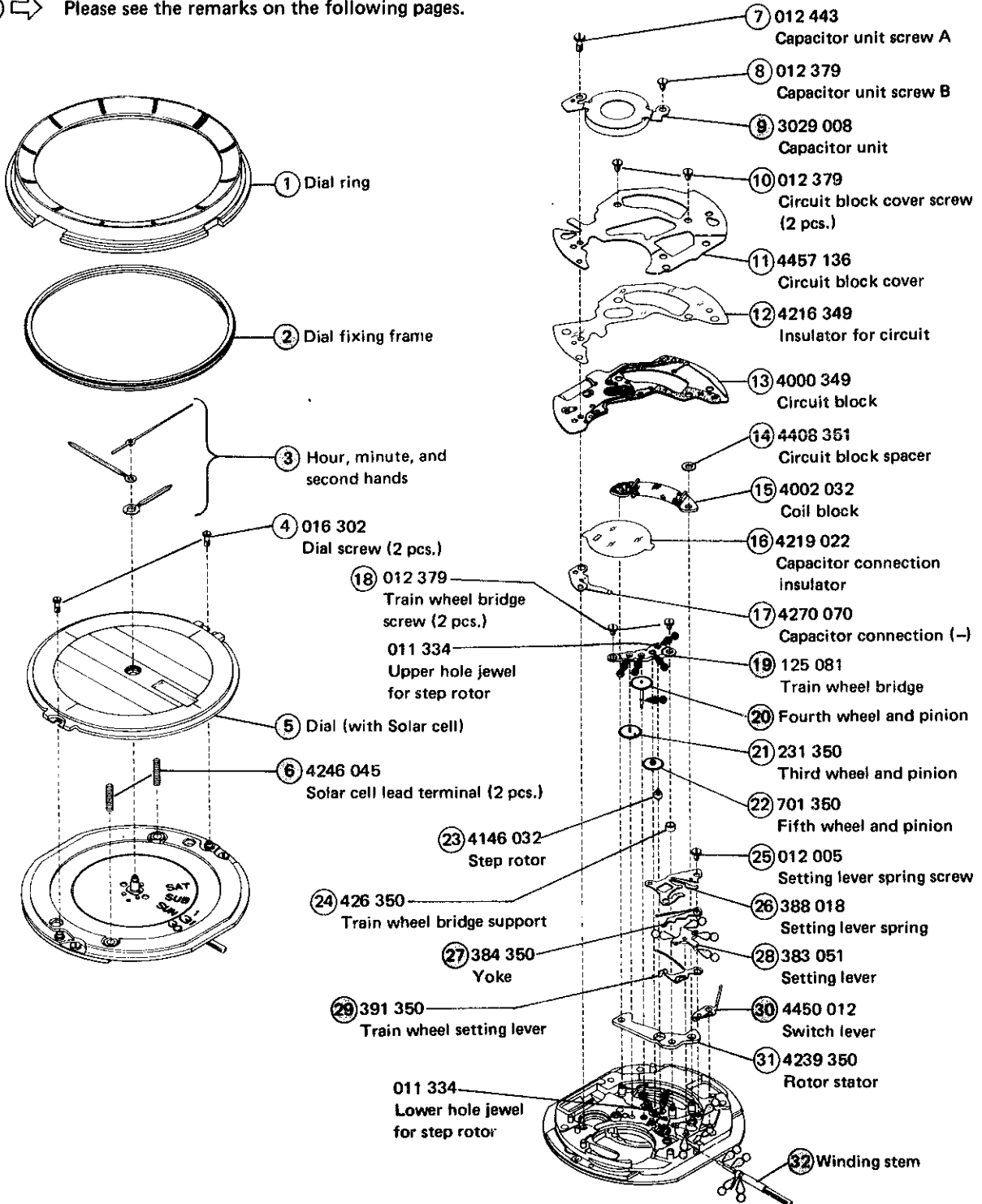



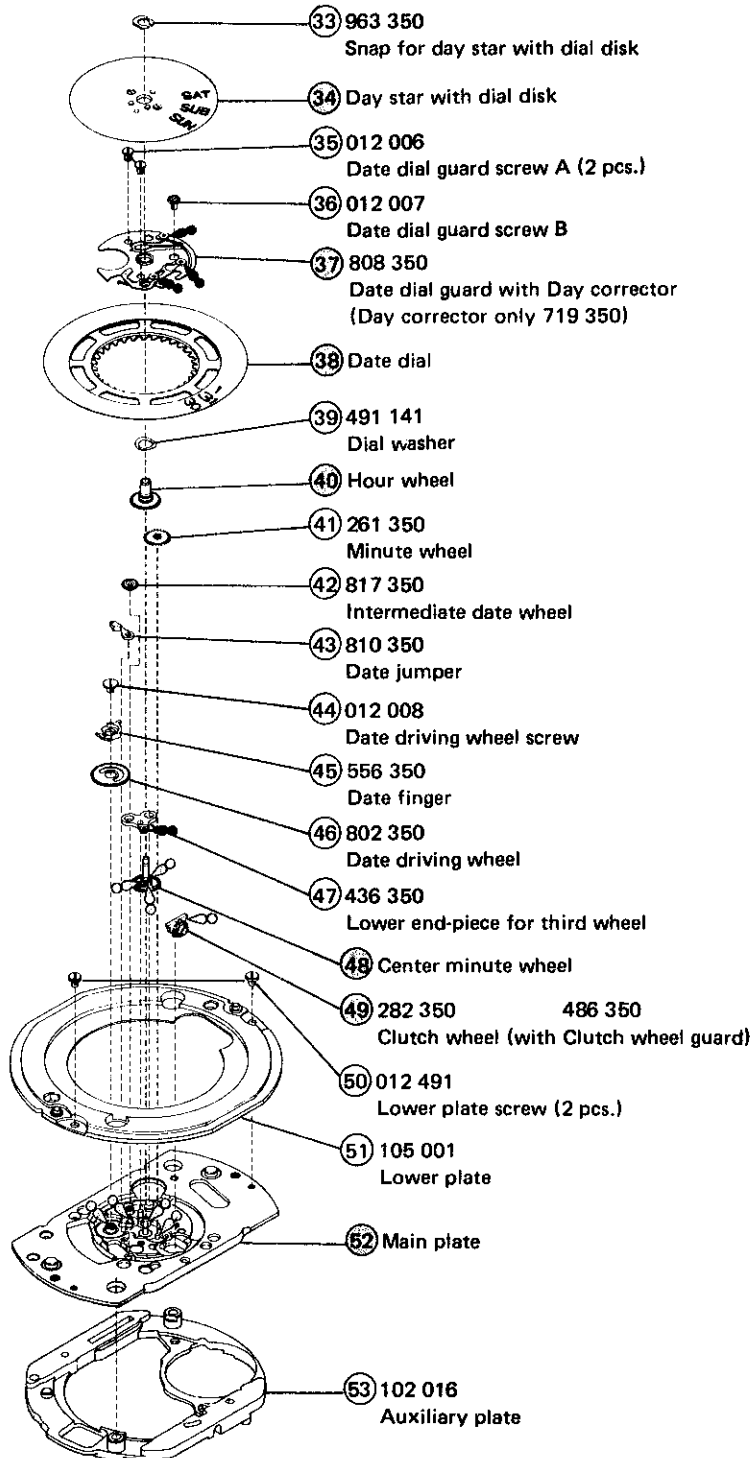

➡ Please see the remarks on the following pages.



PARTS CATALOGUE

Cal. 8S23A





	012 005 Setting lever spring screw (1 pc.)
	012 006 Date dial guard screw A (2 pcs.)
	012 007 Date dial guard screw B (1 pc.)
	012 008 Date driving wheel screw (1 pc.)
	012 379 Capacitor unit screw B (1 pc.) Circuit block cover screw (2 pcs.) Train wheel bridge screw (2 pcs.)
	012 443 Capacitor unit screw A (1 pc.)
	012 491 Lower plate screw (2 pcs.)
	016 302 Dial screw (2 pcs.)

Remarks:

- ②① Fourth wheel and pinion
- ④① Hour wheel
- ④⑧ Center minute wheel

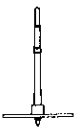
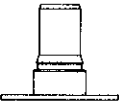
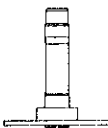
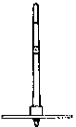
Combination:

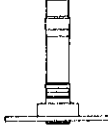
Type	Fourth wheel and pinion	Hour wheel	Center minute wheel
a	 241 136	 271 099	 270 136
b	 241 168	 271 168	 270 168

Parts combination varies, depending on the design of cases. Refer to "SEIKO Casing Parts Catalogue".

- ③② Winding stem 354 351

The type of winding stem is determined based on the design of cases. Check the case number and refer to "SEIKO Casing Parts Catalogue" to choose a corresponding winding stem.

- ③④ Day star with dial disk

Part code	Position of crown	Position of calendar	Language
160 096	3 o'clock	3 o'clock	English ↔ Spanish

If any other type of day star with dial disk is required, please specify the number inscribed on the disk.

③⑧ Date dial

Part code	Position of crown	Position of calendar	Color of figure	Color of background
801 140	3 o'clock & 4 o'clock	3 o'clock	Black	White
801 346	3 o'clock & 4 o'clock	3 o'clock	White	Black
801 373	3 o'clock & 4 o'clock	3 o'clock	Gold	Black

If any other type of date dial is required, please specify ① Cal. No., ② the crown position, ③ the calendar frame position, and ④ Dial No.

⑤② Main plate

There are two types of main plates – one using tubes for dial screw and the other not using them – and they can be used interchangeably.

• Tubes:

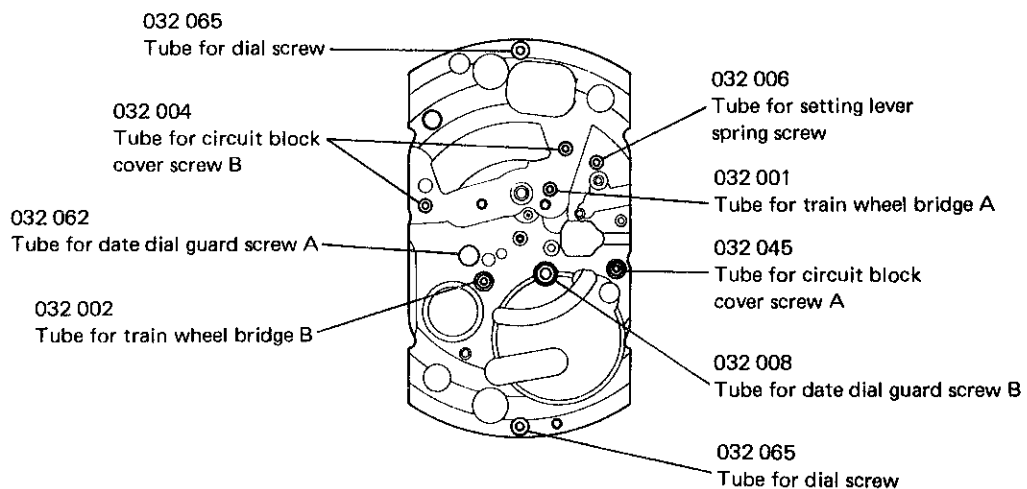

- The explanation here is only for the particular points of Cal. 8S23A.
- For the repairing, checking and measuring procedures, refer to the "TECHNICAL GUIDE, GENERAL INSTRUCTION".

I. STRUCTURE OF THE CIRCUIT BLOCK

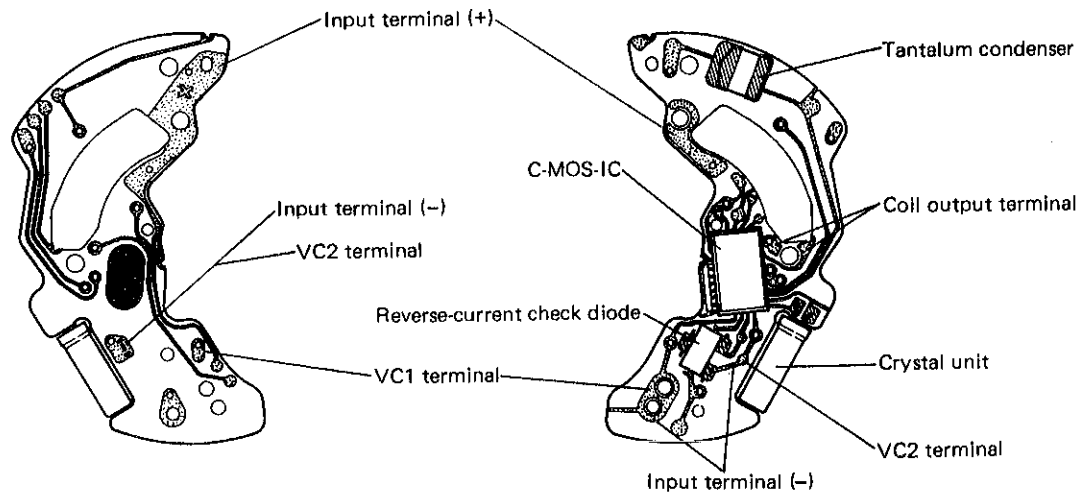

II. REMARKS ON DISASSEMBLING AND REASSEMBLING

Use the universal movement holder for disassembling and reassembling.

② Dial fixing frame

• How to install

1. Set the protrusion on the circumference of the dial fixing frame securely into the groove of the dial ring.
2. Attach the dial to the dial ring with the dial fixing frame, and then put the case on them.

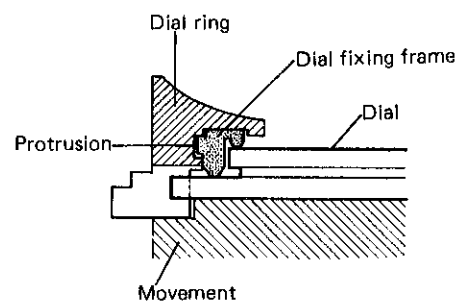

Note: Never lubricate the dial fixing frame.

③ Hands

• Remarks on disassembling

When pulling off the hands with a hand remover, do not use the dial as a fulcrum. Especially the dial center is susceptible to pressure and may be broken if pressure is applied.

⑤ Dial (with Solar cell)

- Be sure to set the dial's guide groove in position with the tubes for dial screw. After tightening up the dial screws, check that the dial moves up and down by resilience from the solar cell lead terminals.
- The solar cell has an amorphous silicone film evaporated onto the glass circuit plate. Do not press its center or subject it to violent shocks. Wipe off contamination on the glass upper surface gently with a nylon cloth. Do not use benzine, Daiflon, alcohol, and any other solution.

⑥ Solar cell lead terminal

The solar cell lead terminal may slightly differ in length from one to another, but they can all be used interchangeably. After attaching the dial, check to see, by seeing through the clearance on the movement side, whether there is any defective conductivity in the two electrodes arising from falling of the solar cell lead terminal(s).

⑨ Capacitor unit

- Never tear off the welded portion of the capacitor unit.

In distinction from a silver oxide battery (to prevent a silver oxide battery from being installed), the capacitor unit is welded with the capacitor holder.

- Check for any leakage from the capacitor unit.

If any leakage is found on the capacitor unit, make necessary repairs for it.

(Refer to "2. CHECKING AND ADJUSTMENT PROCEDURES, B: CHECK CONDUCTIVITY OF THE CAPACITOR UNIT" on page 10.)

- Check for any defective conductivity (contamination).

Wipe off any contamination on the conductive area with a nylon cloth moistened with Daiflon or alcohol, and then dry it with warm air.

- Forced charging may damage the capacitor unit. Never do it.

- After installing the capacitor unit, be sure to reset the circuit.

How to reset the circuit:

Short the circuit block input terminal (-) and the circuit block cover with tweezers.

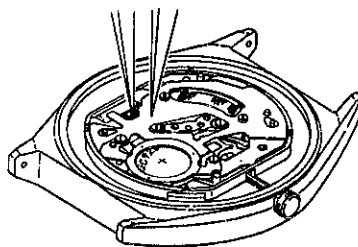

⑱ Train wheel bridge

- **Setting position**

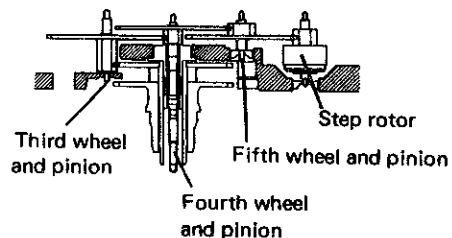
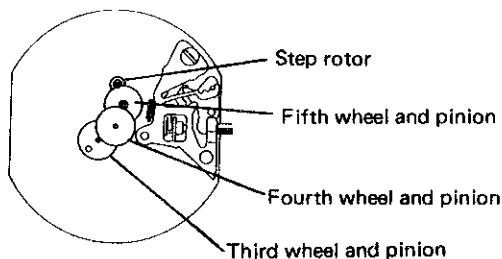

②⑦ Yoke

● **Installing**

Install the yoke so that its spring correctly meshes with the setting portion of the train wheel setting lever.

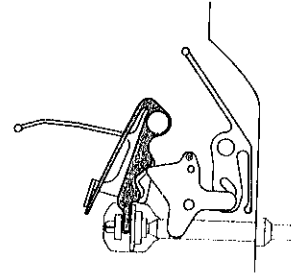

②⑨ Train wheel setting lever

③① Switch lever

● **Remarks on reassembling**

After reassembling up to ①⑧ Train wheel bridge screw, check the position of the train wheel setting lever's reset portion and that of the switch lever.

● **With the crown at the normal position**

● **With the crown at the second click position**

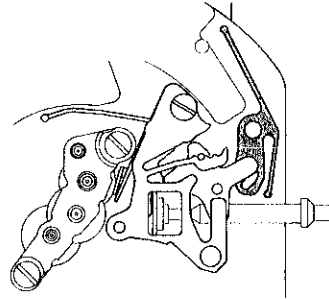
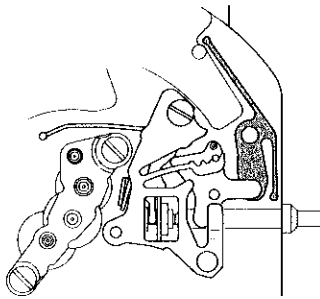

③⑦ Date dial guard (Only for Cal. 8S23A)

● **Installing**

Install the date dial guard so that the date jumper's spring correctly meshes with the date jumper.

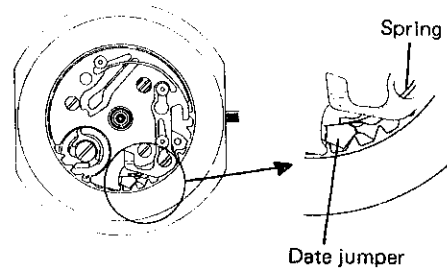

④⑨ Clutch wheel (with Clutch wheel guard)

● **Remarks on disassembling and reassembling**

The clutch wheel has a clutch wheel guard. Do not remove the clutch wheel guard except when replacing the clutch wheel or the clutch wheel guard. When replacing either of them, be sure to pass a stick through the clutch wheel so that it may not turn during the work.



III. CHECKING AND ADJUSTMENT

Cal. 8S23A

1. GUIDE TABLE FOR CHECKING AND ADJUSTMENT

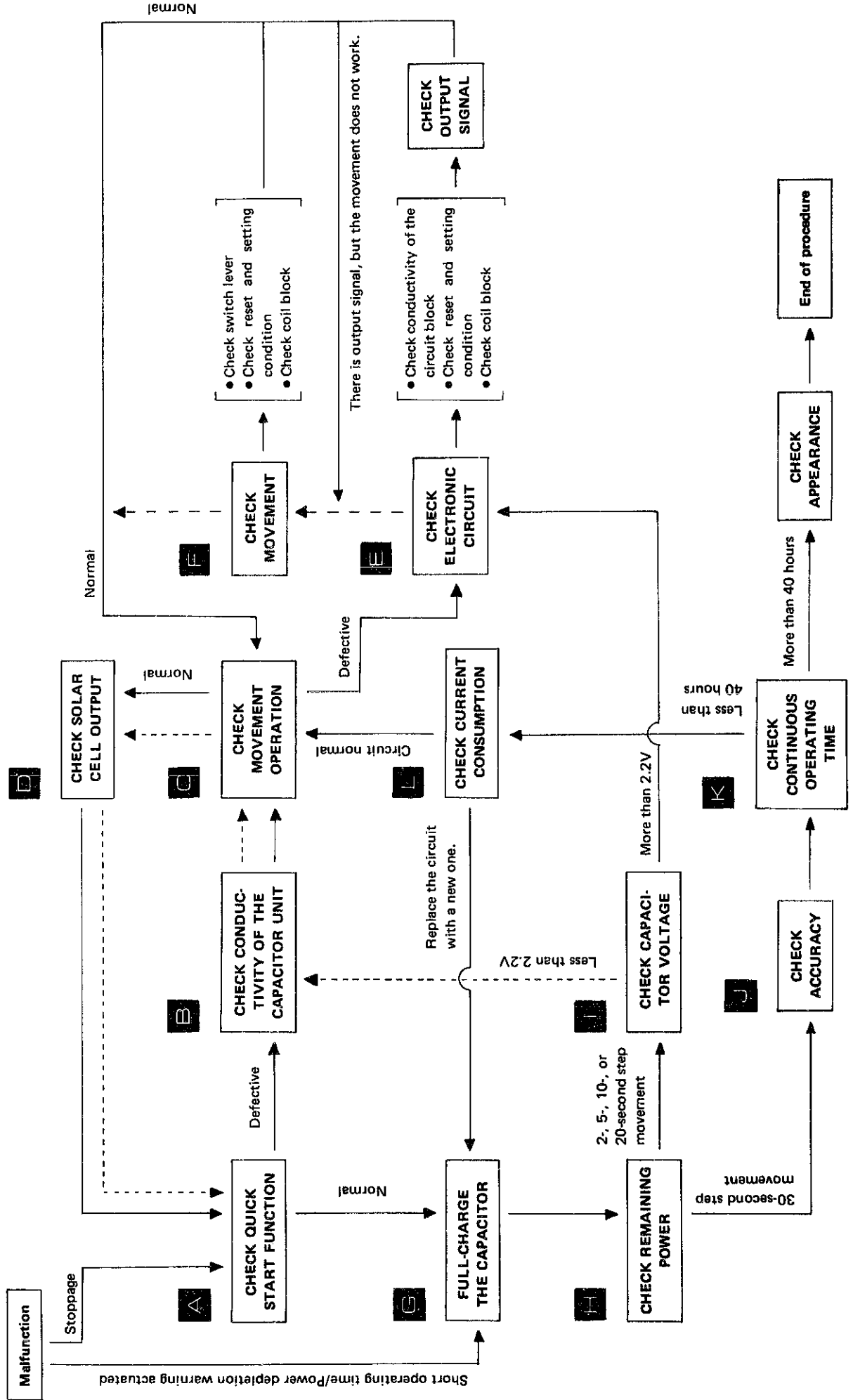

2. CHECKING AND ADJUSTMENT PROCEDURES



CHECK QUICK START FUNCTION

With the watch complete (case back closed), check that the second hand moves normally.

No.	Preparation	Checking points	Result	Adjustment and Repair
①	Place the watch complete 20 cm right below a fluorescent lamp (15W) and expose the solar cell to light.	Check that the second hand moves several seconds after exposure to light.	<ul style="list-style-type: none"> • Normal: 2-second step movement • Defective: Does not move 	<p>Proceed to G: FULL-CHARGE THE CAPACITOR.</p> <p>Proceed to B: CHECK CONDUCTIVITY OF THE CAPACITOR UNIT.</p>



CHECK CONDUCTIVITY OF THE CAPACITOR UNIT

With the watch complete (case back opened), check conductivity of the capacitor unit.

No.	Preparation	Checking points	Result	Adjustment and Repair
①	Watch complete without case back	Check that the capacitor unit screws are not loosened.	<ul style="list-style-type: none"> • Not loosened • Loosened 	<p>Proceed to ② .</p> <p>This is considered to be a cause of irregularity. After going through ⑦ , proceed to C: CHECK MOVEMENT OPERATION.</p>
②	Capacitor unit alone	Check that the welded portion of the capacitor unit does not come off.	<ul style="list-style-type: none"> • Does not come off • Has come off 	<p>Proceed to ③ .</p> <p>Replace the capacitor unit with a new one. Then, proceed to ③ .</p>
③		Check that there is no leakage.	<ul style="list-style-type: none"> • No leakage • Leakage 	<p>Proceed to ④ .</p> <p>Make necessary repairs.* Then, proceed to ④ .</p>

*How to repair leakage from the capacitor unit

<ul style="list-style-type: none"> • Disassemble the movement. • Circuit block alone • Other parts 	<p>Refer to "OVERHAUL AND CLEANING" in the "TECHNICAL GUIDE, GENERAL INSTRUCTIONS".</p> <p>Wipe off the leakage on the circuit block.</p> <ol style="list-style-type: none"> 1) Wipe the leakage affected area with a nylon cloth moistened with distilled water or city water. (Any residual water may cause rust.) 2) Wipe the area again with a nylon cloth moistened with alcohol. 3) Using a hair dryer, dry the area with warm air. (Be careful not to overheat it.) <p>Wash each part contaminated with leakage. In the case of heavy leakage contamination that may cause rust, replace the part with a new one.</p>
---	---

B

CHECK CONDUCTIVITY OF THE CAPACITOR UNIT (continued)

No.	Preparation	Checking points	Result	Adjustment and Repair
④	Watch complete without case back and capacitor unit	Check that the capacitor connection insulator is properly installed.	<ul style="list-style-type: none"> • Properly installed • Out of position 	Proceed to ⑤ . Reset the capacitor connection insulator in position. Then, proceed to ⑤ .
⑤		Check that the capacitor connection insulator is not broken.	<ul style="list-style-type: none"> • Not broken • Broken 	Proceed to ⑥ . Replace the capacitor connection insulator with a new one. Then, proceed to ⑥ .
⑥		Check that there is no defective conductivity (such as a short or contamination) in the capacitor unit and the capacitor connection (-).	<ul style="list-style-type: none"> • No defective conductivity • Defective conductivity 	Proceed to ⑦ . Remove the cause for defective conductivity. Wipe off contamination with a nylon cloth moistened with alcohol. Then, proceed to ⑦ .
⑦		Check that the capacitor connection (-) is not deformed or broken.	<ul style="list-style-type: none"> • Neither deformed nor broken • Deformed or broken 	Proceed to C: CHECK MOVEMENT OPERATION. Replace the capacitor connection (-) with a new one. Then proceed to C: CHECK MOVEMENT OPERATION.



CHECK MOVEMENT OPERATION

With the watch complete (case back opened), check to see if the movement works normally.

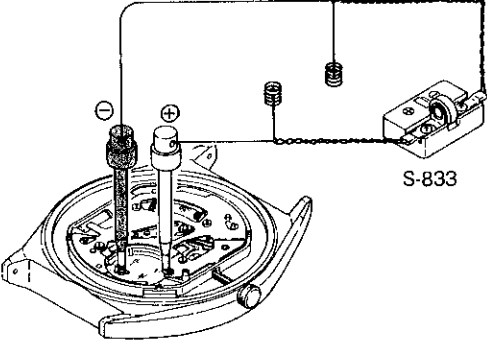
No.	Preparation	Checking points	Result	Adjustment and Repair
①	<ul style="list-style-type: none">• Watch complete without case back and capacitor unit• Tighten the capacitor unit screws (2 pcs.).• Connect to a power supplier.	<p>Check that the movement works with an external power source (1.55V).</p> <p>Red probe : Circuit block cover's (+) conductive portion</p> <p>Black probe: Circuit block's input terminal (-) or Capacitor connection (-)</p> 	<ul style="list-style-type: none">• 1-second step movement• 2-second step movement or stoppage	<p>Proceed to D: CHECK SOLAR CELL OUTPUT.</p> <p>Proceed to E: CHECK ELECTRONIC CIRCUIT.</p>



CHECK SOLAR CELL OUTPUT

Check conductivity and output of the solar cell.

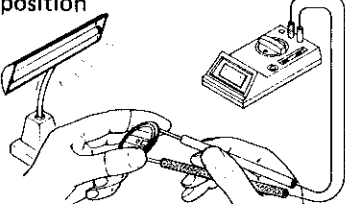
No.	Preparation	Checking points	Result	Adjustment and Repair
①	Movement with dial and hands	<p>Check that there is no defective electrical contact between the dial (solar cell) and the solar cell lead terminal.</p> <p>Solar cell lead terminal</p> <ul style="list-style-type: none"> • Fallen • Broken • Contaminated 	<ul style="list-style-type: none"> • No defective contact • Defective contact 	Proceed to ② .
②	<ul style="list-style-type: none"> • Movement without dial and hands • Dial (solar cell) alone 	<p>Check that there is no scratch or crack on the dial (solar cell) or contamination on the electrodes which may cause defective conductivity.</p>	<ul style="list-style-type: none"> • No defective conductivity • Defective conductivity 	<p>Proceed to ③ .</p> <p>Remove contamination.</p> <p>Replace the scratched or cracked dial with a new one.</p> <p>Then, proceed to ③ .</p>
③	<ul style="list-style-type: none"> • Dial (solar cell) alone • Place the dial 20 cm right below a fluorescent lamp (15W) and expose the solar cell to light. • Connect a volt-ohm-meter. 	<p>Refer to "TECHNICAL GUIDE, GENERAL INSTRUCTION".</p> <p>Apply the probes through the inlets on the back of the dial as follows:</p> <p>Red probe: (+) electrode located on an inlet at the 4 – 6 o'clock position</p> <p>Black probe: (-) electrode located on an inlet at the 10 – 12 o'clock position</p> 	<ul style="list-style-type: none"> • Normal: More than 3.0V • Defective: Less than 3.0V 	<p>Proceed to ④ .</p> <p>Replace the dial with a new one.</p> <p>Then, proceed to ④ .</p>
④	Solar cell lead terminals alone	<p>Check that the solar cell lead terminals are not broken, deformed, or contaminated.</p>	<ul style="list-style-type: none"> • Neither broken, nor deformed, nor contaminated • Broken, deformed or contaminated 	<p>Replace the circuit block with a new one.</p> <p>Then, proceed to A: CHECK QUICK START FUNCTION.</p> <p>Wipe off contamination with a cloth moistened with alcohol.</p> <p>Replace the broken or deformed solar cell lead terminal with a new one.</p> <p>Then, proceed to A: CHECK QUICK START FUNCTION.</p>



FULL-CHARGE THE CAPACITOR

Full-charge the capacitor with the watch complete (case back closed).

No.	Preparation	Checking points	Result	Adjustment and Repair
①	<ul style="list-style-type: none"> • Watch complete with the case back closed • Expose the solar cell to light. 	<p>[Suggested charging time]</p> <ul style="list-style-type: none"> • Sunlight <ul style="list-style-type: none"> Under direct sunlight: More than 5 minutes Outdoor on a cloudy day: More than 80 minutes • Fluorescent lamp (15W x 2, right below 12 cm) <ul style="list-style-type: none"> More than 3 hours 	<ul style="list-style-type: none"> • Full charge 	Proceed to H: CHECK REMAINING POWER.



CHECK REMAINING POWER

With the watch complete, check the remaining power.

No.	Preparation	Checking points	Result	Adjustment and Repair
①	Watch complete with the capacitor fully recharged	With the crown at the first click position, actuate the remaining power check function, keeping the solar cell exposed to light of the same illuminance as at charging.	<ul style="list-style-type: none"> • Normal: 30-second step movement • Defective: 2-, 5-, 10-, or 20-second step movement 	<p>Proceed to J: CHECK ACCURACY.</p> <p>Proceed to I: CHECK CAPACITOR VOLTAGE.</p>

I

CHECK CAPACITOR VOLTAGE

Check voltage of the capacitor unit.

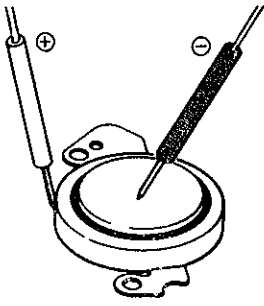
No.	Preparation	Checking points	Result	Adjustment and Repair
①	<ul style="list-style-type: none"> • Watch complete with the capacitor unit fully charged • Remove the case back and the capacitor unit. • Capacitor unit alone • Connect a volt-ohmmeter. 	<p>Measure the capacitor unit's voltage.</p> <p>Red probe : Capacitor unit (+) Black probe: Capacitor unit (-)</p> 	<ul style="list-style-type: none"> • Normal: More than 2.2V • Defective: Less than 2.2V 	<p>Proceed to E: CHECK ELECTRONIC CIRCUIT.</p> <p>Proceed to B: CHECK CONDUCTIVITY OF THE CAPACITOR UNIT. Then, proceed to D: CHECK SOLAR CELL OUTPUT.</p>

K

CHECK CONTINUOUS OPERATING TIME

With the watch complete (case back closed), check continuous operating time.

No.	Preparation	Checking points	Result	Adjustment and Repair
①	<ul style="list-style-type: none"> • Watch complete with the case back closed • Place the watch complete 12 cm right below two fluorescent lamps (15W) and expose the solar cell to light for 1.5 ~ 2.0 hours. 	<p>Check how many hours the capacitor lasts after full charge.</p> <p>(1) Check full charge by actuating the remaining power check function. (2) Set the time, date, and day. (3) Leave the watch in a darkroom (a place out of light.)</p>	<ul style="list-style-type: none"> • More than 40 hours • Less than 40 hours 	<p>Proceed to ② .</p> <p>Proceed to L: CHECK CURRENT CONSUMPTION.</p>
②	<ul style="list-style-type: none"> • Watch complete with the case back closed • Remaining power check function 	<p>With the crown at the first click position, check to see how the second hand moves.</p>	<ul style="list-style-type: none"> • 10- or 20-second step • 2- or 5-second step 	<p>Proceed to CHECK APPEARANCE.</p> <p>Proceed to L: CHECK CURRENT CONSUMPTION.</p>



CHECK CURRENT CONSUMPTION

For other than the procedure described below, refer to the "TECHNICAL GUIDE, GENERAL INSTRUCTION".

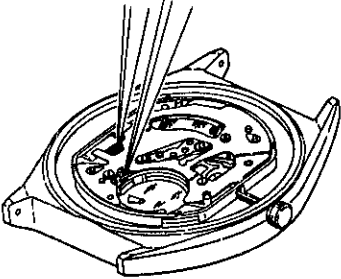
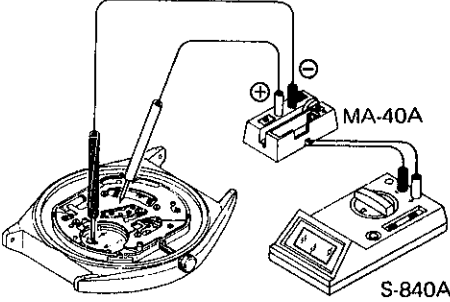
No.	Preparation	Checking points	Result	Adjustment and Repair
①	<ul style="list-style-type: none"> • Watch complete without case back and capacitor unit • Tighten the capacitor unit screws (2 pcs.). • Short-circuit the circuit block's VC1 terminal and VC2 terminal with tweezers. • Connect to a power supplier. 	<p>Short-circuit VC1 – VC2, and then apply the probes as follows:</p> <p>Red probe: Circuit block cover's (+) conductive portion</p> <p>Black probe: Circuit block's input terminal (-) or Capacitor connection (-)</p> <div style="display: flex; justify-content: space-around; align-items: center;">   </div>	<ul style="list-style-type: none"> • Less than 1.5μA • More than 1.5μA 	<p>Replace the capacitor unit with a new one. Then, proceed to G: FULL-CHARGE THE CAPACITOR.</p> <p>Proceed to ② .</p>
②	<ul style="list-style-type: none"> • Circuit block alone • Short-circuit the circuit block's VC1 terminal and VC2 terminal with tweezers. • Connect to the power supplier. 	<p>Short-circuit VC1 – VC2, and then apply the probes as follows:</p> <p>Red probe : Input terminal (+)</p> <p>Black probe: Input terminal (-)</p>	<ul style="list-style-type: none"> • Less than 0.8μA • More than 0.8μA 	<p>Proceed to C: CHECK MOVEMENT OPERATION.</p> <p>Replace the circuit block with a new one. Then, proceed to G: FULL-CHARGE THE CAPACITOR.</p>

3. OTHER CHECKING AND ADJUSTMENT PROCEDURE

Check resistance of the coil block.

3.0KΩ ~ 3.4KΩ

PARTS CATALOGUE

Cal. 8S21A

Disassembling procedures Figs.: ① → ④②
 Reassembling procedures Figs.: ④② → ①

Lubricating: Types of oil Oil quantity

● Moebius A ○ Normal quantity

⊖ SEIKO Watch Oil S-6



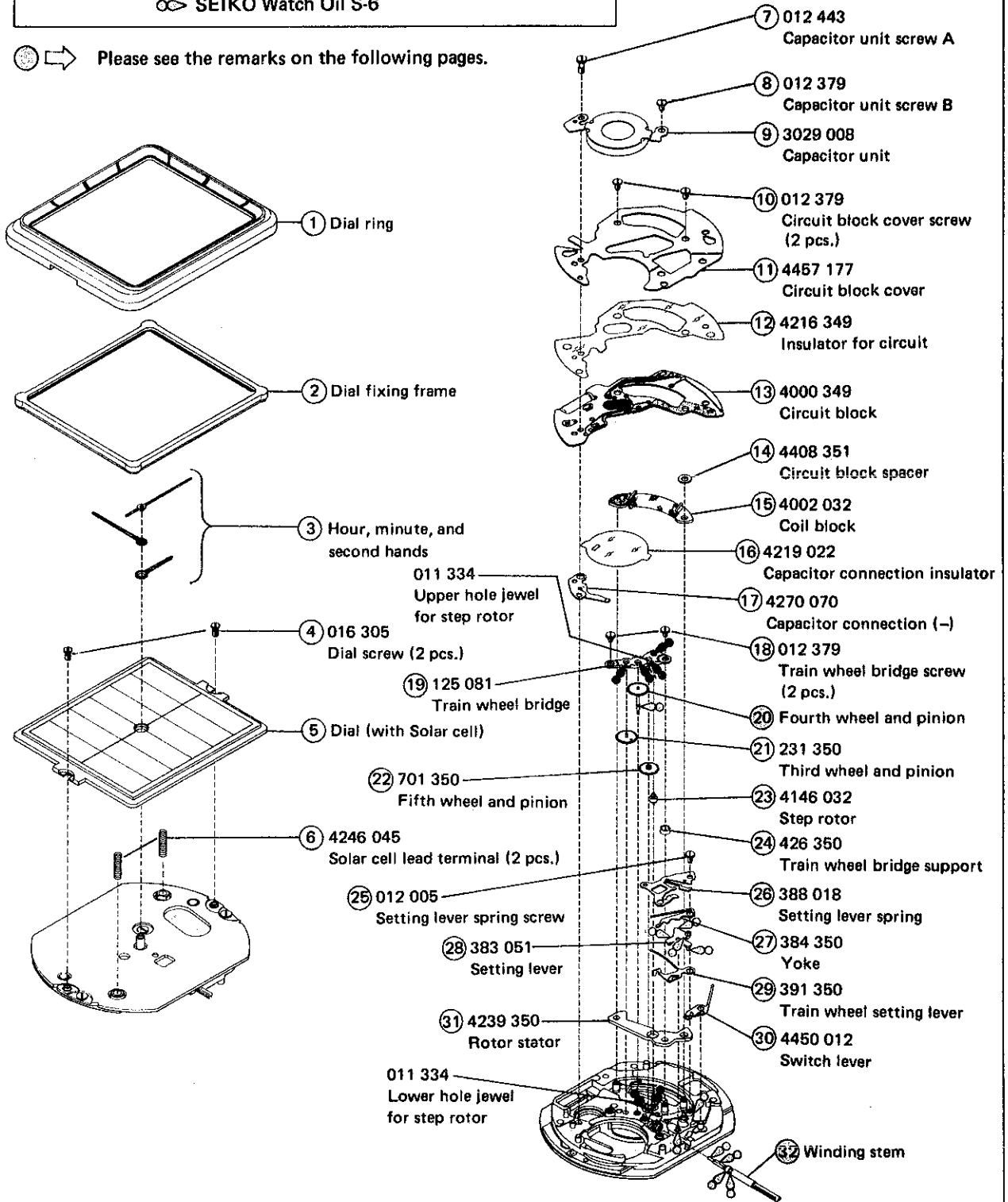

⊖ → Please see the remarks on the following pages.

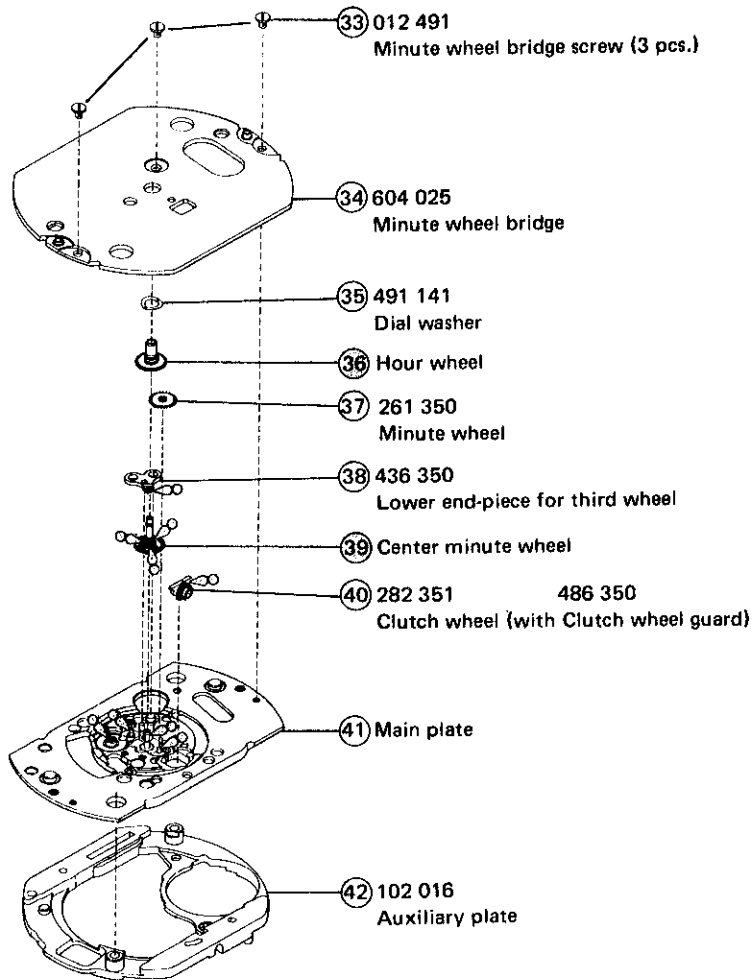

PARTS CATALOGUE

Cal. 8S21A

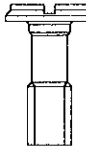

	012 005 Setting lever spring screw (1 pc.)
	012 379 Capacitor unit screw B (1 pc.) Circuit block cover screw (2 pcs.) Train wheel bridge screw (2 pcs.)
	012 443 Capacitor unit screw A (1 pc.)
	012 491 Minute wheel bridge screw (3 pcs.)
	016 305 Dial screw (2 pcs.)



PARTS CATALOGUE

Cal. 8S21A

Remarks:

- ②① Fourth wheel and pinion
- ③⑥ Hour wheel
- ③⑨ Center minute wheel

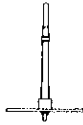
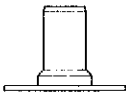
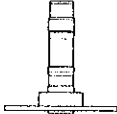
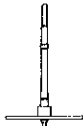
Combination:

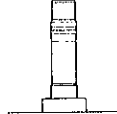
Type	Fourth wheel and pinion	Hour wheel	Center minute wheel
a	 241 151	 271 151	 270 151
b	 241 169	 271 169	 270 169

Parts combination varies, depending on the design of cases. Refer to "SEIKO Casing Parts Catalogue".

③② Winding stem 354 351

The type of winding stem is determined based on the design of cases. Check the case number and refer to "SEIKO Casing Parts Catalogue" to choose a corresponding winding stem.

• Tubes:

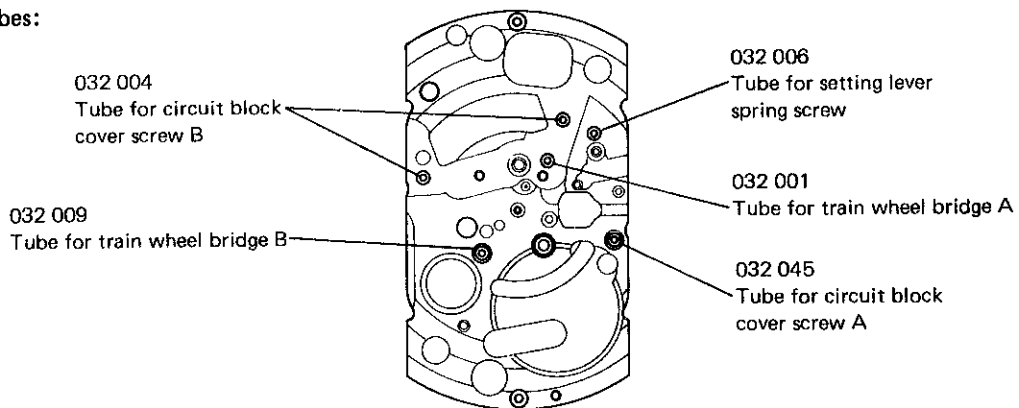

TECHNICAL GUIDE

Cal. 8S21A

For the repairing, checking and measuring procedures of Cal. 8S21A, refer to the "TECHNICAL GUIDE" for Cal. 8S23A on pages 6 ~ 16.