

TECHNICAL GUIDE

SEIKO
QUARTZ

CAL. 8522A
CAL. 8523A

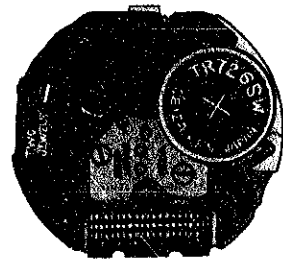
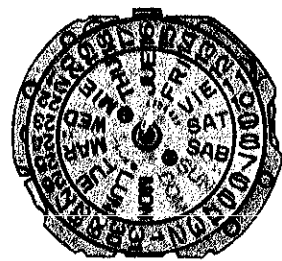

CONTENTS

I. SPECIFICATIONS	1
II. STRUCTURE OF THE CIRCUIT BLOCK	1
III. DISASSEMBLING, REASSEMBLING AND LUBRICATING	2
1. Indicating mechanism	2
2. Electronic circuit and gear train mechanism	3
3. Calendar and setting mechanism	4
IV. CHECKING AND ADJUSTMENT	5
• Check output signal	5
• Check battery voltage	5
• Check battery and circuit block conductivity	5
• Check reset and train wheel setting conditions	5
• Check coil block	6
• Check current consumption	7
• Check accuracy	7

I. SPECIFICATIONS

Item	Cal. No.	8522A	8523A
Time indication		3 hands	
Additional mechanism		Date	Day and date
		Instant date setting device	Instant day and date setting device
			Bilingual changeover system for the day of the week
		Train wheel setting device	
		Electronic circuit reset switch	
		Battery life indicator	
Loss/gain		Loss/gain at normal temperature range Monthly rate : less than 15 seconds (Annual rate : less than 3 minutes)	
Outside diameter		φ18.0 mm	
Casing diameter		φ17.6 mm (16.0 mm between the 3 o'clock and the 9 o'clock sides)	
Height		3.9mm without battery	3.8mm without battery
Regulation system		Trimmer condenser	
Measuring gate by Quartz tester		Any gate is available.	
Battery		Battery life is approximately 3 years for Maxell SR726SW, SEIKO (SEIZAIKEN) TR726SW or SB-DL and approximately 2 years for U.C.C. 397. Voltage: 1.55V	
Jewels		2 jewels	

II. STRUCTURE OF THE CIRCUIT BLOCK

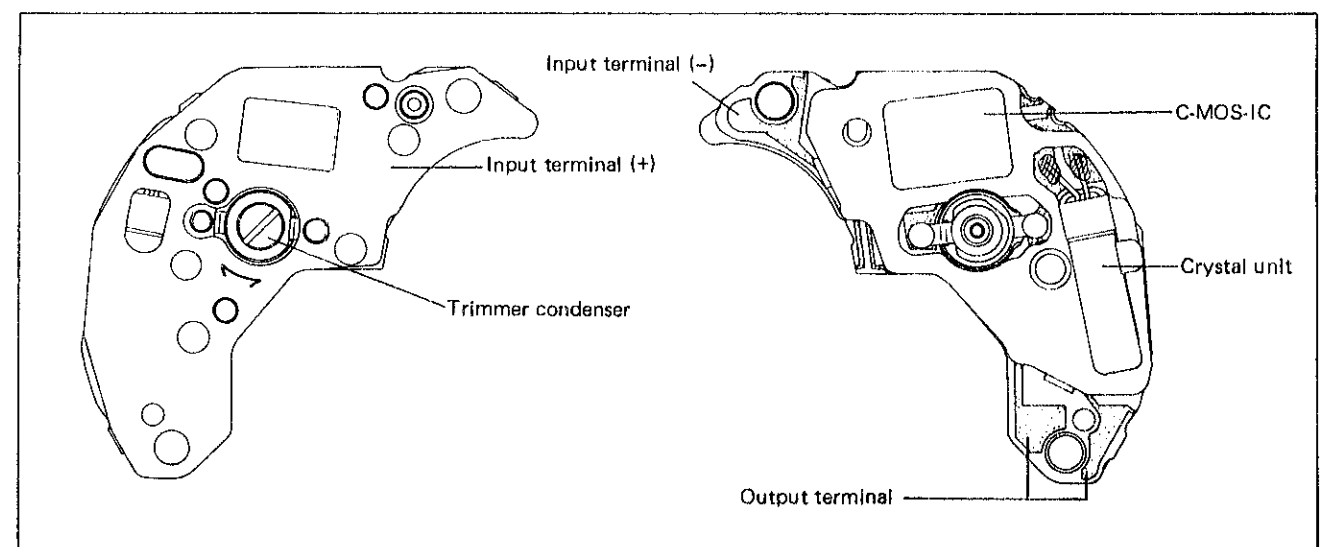

III. DISASSEMBLING, REASSEMBLING AND LUBRICATING

Cal. 8523A is taken as an example to describe the disassembling and reassembling procedures. Cal. 8522A is a variation of Cal. 8523A without a day star with dial disk and consequently has not a snap for day star with dial disk and a day corrector. The shape of the date dial guard and the circuit block marking of Cal. 8522A are also different from those of Cal. 8523A.

Disassembling procedures Figs.: ① → ④③

Reassembling procedures Figs.: ④③ → ①

Lubricating

Type of oil

● Moebius A

○ SEIKO Watch Oil S-6

Oil quantity

● Normal quantity

- Use the movement holder S-665 except when disassembling and reassembling the calendar and setting mechanism, in which case a flat-top desk is desirable.

1. Indicating mechanism

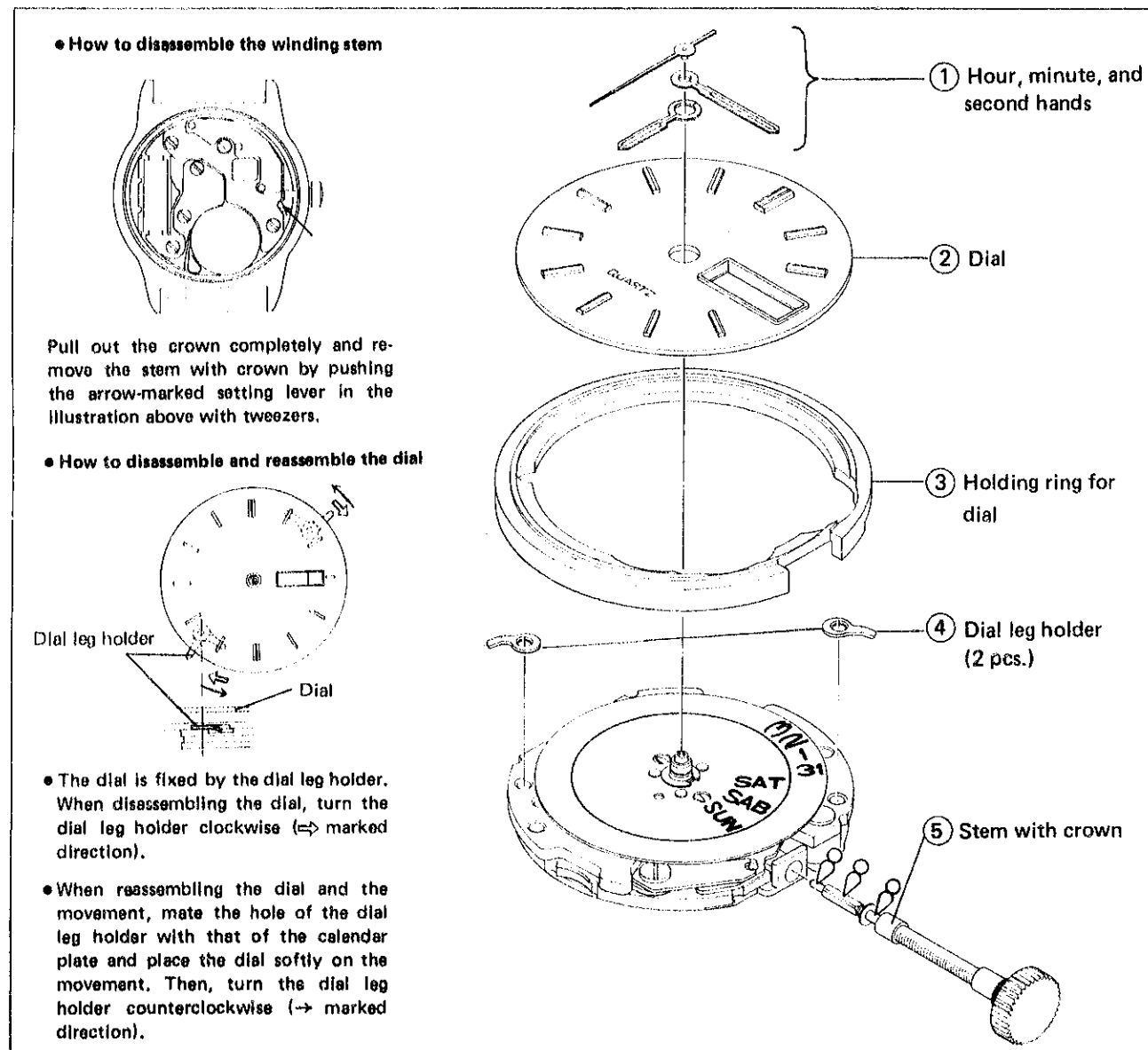

2. Electronic circuit and gear train mechanism

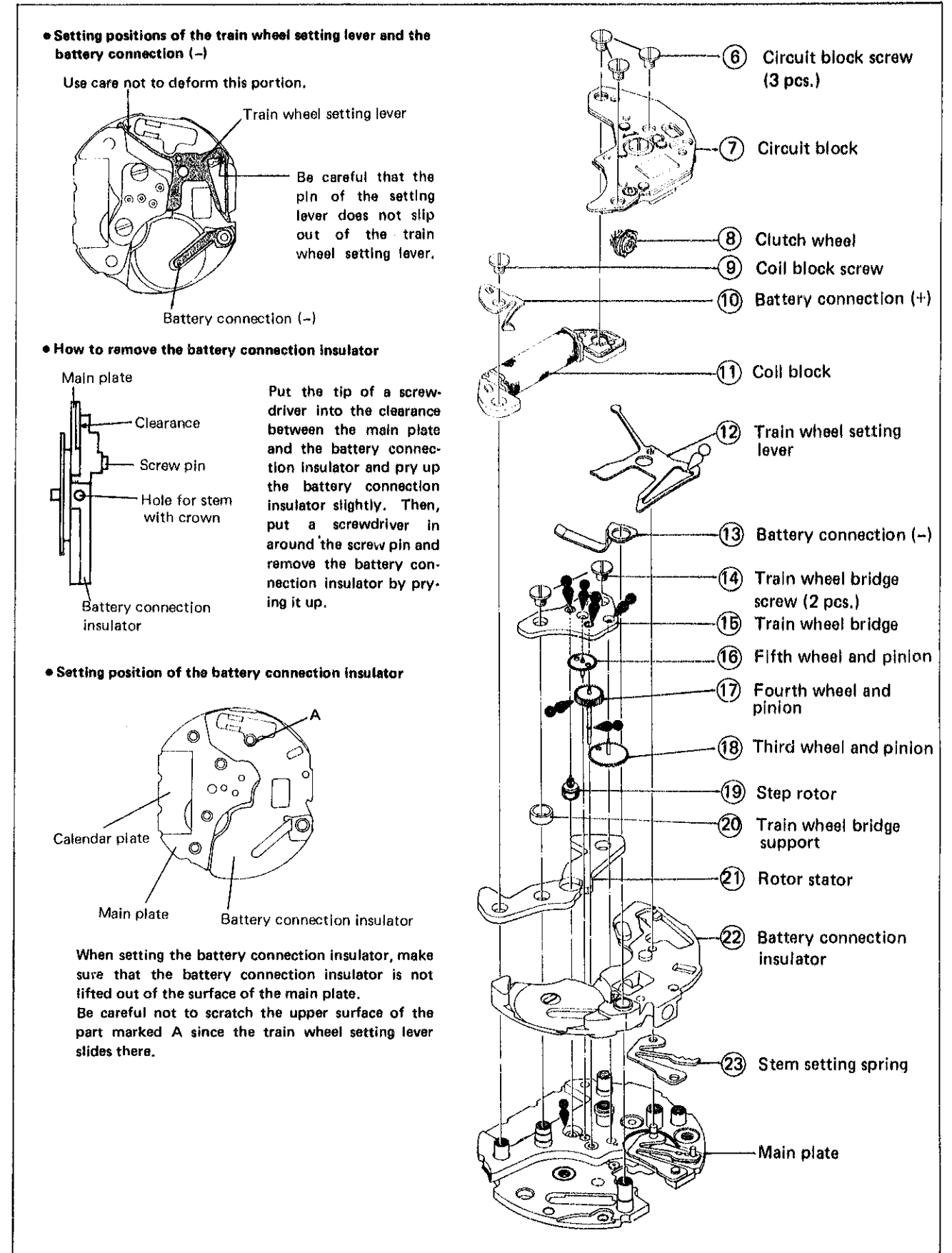

3. Calendar and setting mechanism

• Snap for day star with dial disk

1 How to disassemble

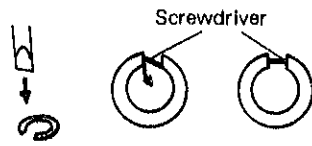

By using a screwdriver which is a little larger in width than the space of the snap for day star with dial disk, pry it open as shown in the illustration above.

2 How to reassemble

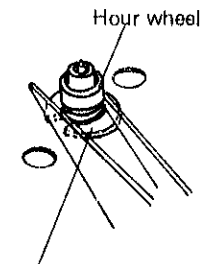

Insert the snap for day star with dial disk in position with tweezers, being careful not to bend it. After setting it, make sure that there is no slippage between the day star with dial disk and the snap for it.

Snap for day star with dial disk

• Setting position of the date jumper

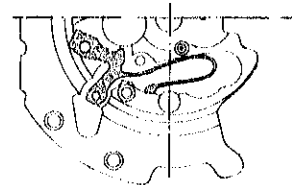

• Setting positions of the setting lever and the yoke

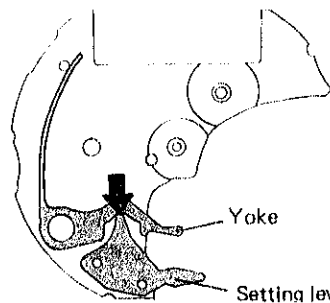

Set the tip of the setting lever in the arrow-marked position to enable the clutch wheel to be set easily.

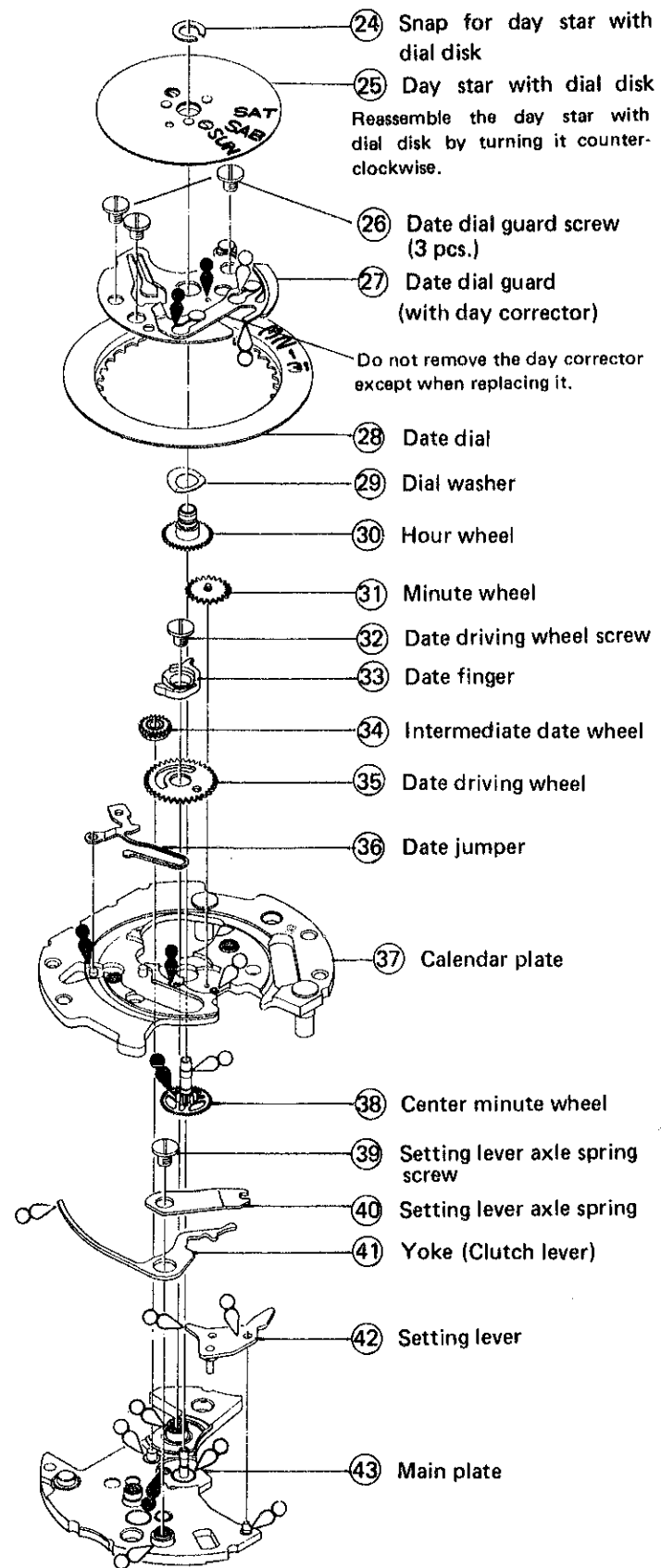

24 Snap for day star with dial disk

25 Day star with dial disk
Reassemble the day star with dial disk by turning it counter-clockwise.

26 Date dial guard screw (3 pcs.)

27 Date dial guard (with day corrector)

Do not remove the day corrector except when replacing it.

28 Date dial

29 Dial washer

30 Hour wheel

31 Minute wheel

32 Date driving wheel screw

33 Date finger

34 Intermediate date wheel

35 Date driving wheel

36 Date jumper

37 Calendar plate

38 Center minute wheel

39 Setting lever axle spring screw

40 Setting lever axle spring

41 Yoke (Clutch lever)

42 Setting lever

43 Main plate

IV. CHECKING AND ADJUSTMENT

Procedures

CHECK OUTPUT SIGNAL

Result:
Input indicator blinks every second: Normal
Input indicator does not blink every second: Defective

CHECK BATTERY VOLTAGE

Result:
More than 1.5V: Normal
Less than 1.5V: Defective
Replace the battery with a new one.

CHECK BATTERY AND CIRCUIT BLOCK CONDUCTIVITY

CHECK RESET AND TRAIN WHEEL SETTING CONDITIONS

1. Check to see if the second hand stops promptly when the crown is pulled out to the second click position and if it starts promptly one second after the crown is pushed in back to the first click or the normal position.

Reset condition can also be confirmed by the procedure CHECK OUTPUT SIGNAL.
Crown at the second click position : Does not blink every second.
Crown at the first click or the normal position: Blinks every second.

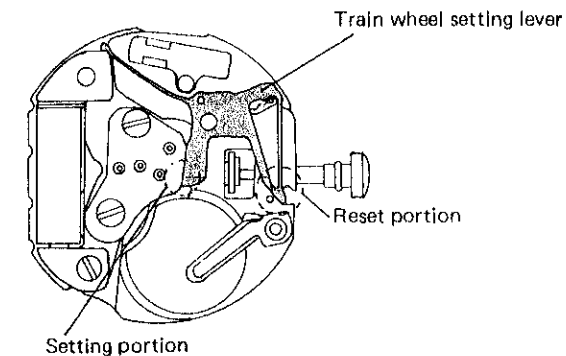

Result:
The second hand stops promptly and starts after one second: Normal
The second hand does not stop or starts irregularly: Defective
Check the reset and setting portions of the train wheel setting lever.

2. Check the reset portion of the train wheel setting lever with the circuit block disassembled. Make sure that the train wheel setting lever is not lifted at all out of the battery connection insulator.

• With the crown at the normal and the first click positions

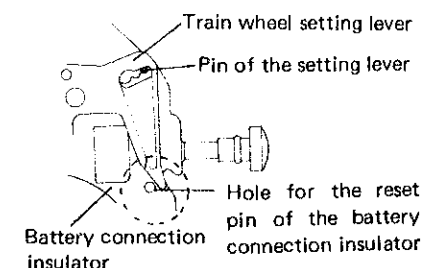

Normal

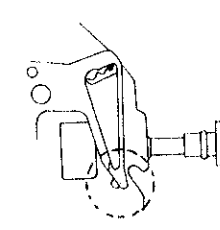

Defective

Result:
The whole of the reset pin hole can be seen: Normal
About half of the reset pin hole can be seen: Defective

- Check the pin of the setting lever for bend, oil conditions, etc.
- Replace the train wheel setting lever with a new one.

Procedures

● With the crown at the second click position

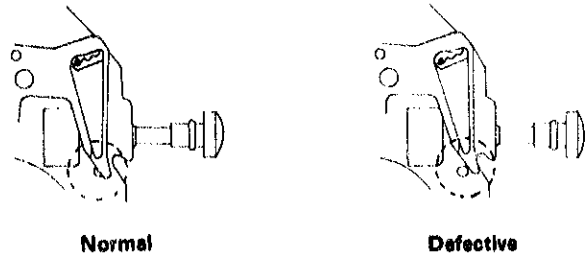

Result:
 About half of the reset pin hole can be seen: Normal
 The whole of the reset pin hole can be seen: Defective

- Check the pin of the setting lever for bend, oil conditions, etc.
- Replace the train wheel setting lever with a new one.

3. Check the setting portion of the train wheel setting lever with the circuit block disassembled. Make sure that the train wheel setting lever is not lifted at all out of the battery connection insulator.

● With the crown at the normal and the first click positions

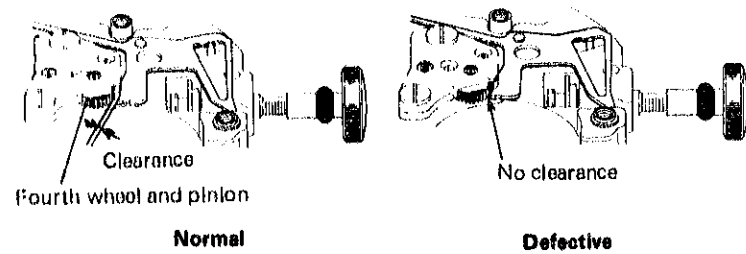

Result:
 Clearance between the fourth wheel and pinion and the train wheel setting lever: Normal
 No clearance: Defective

- Check the pin of the setting lever for bend, oil conditions, etc.
- Replace the train wheel setting lever with a new one.

● With the crown at the second click position

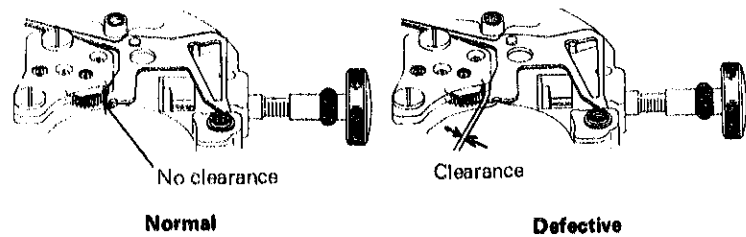

Result:
 No clearance: Normal
 Clearance : Defective

- Check the pin of the setting lever for bend, oil conditions, etc.
- Replace the train wheel setting lever with a new one.

CHECK COIL BLOCK

Result:
 2.3KΩ – 2.9KΩ : Normal
 Less than 2.3KΩ (Short circuit)
 More than 2.9KΩ (Broken wire) } Defective

Replace the coil block with a new one.

Procedures

CHECK CURRENT CONSUMPTION

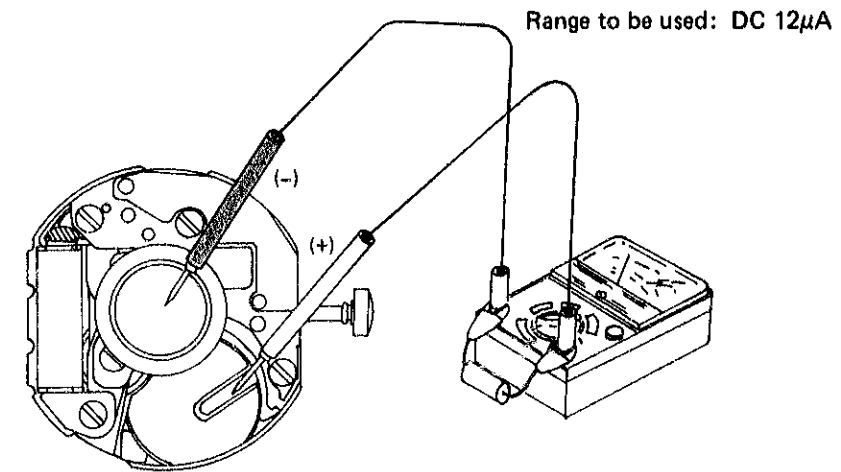

Result:
 Less than 1.2μA: Normal
 More than 1.2μA: Defective

CHECK ACCURACY

All procedures of Disassembling, Reassembling, Lubricating, Checking and Adjustment are completed.