

SEIKO

QUARTZ LC

Cal.0439A

PARTS LIST

Calibre No. <h1 style="text-align: center;">0439A</h1>	Jewels <h2 style="text-align: center;">0j</h2>	Style Name <h1 style="text-align: center;">QUARTZ LC</h1>
--	--	---

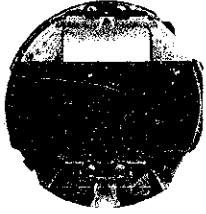

Characteristics

Casing diameter : ϕ 27.0 mm
 Maximum height : 5.5 mm
 Frequency of quartz crystal oscillator : 32,768 Hz
 (Hz=Hertz Cycle per second)
 Time functions : Digital Display System showing hour, AM, PM, minute and second
 Calendar functions : Digital Display System showing month and date upon command
 Display medium : Single Crystal Display (Nematic Liquid Crystal, FE-mode)
 Illuminating light : Illuminated in coordination with the touch-button depressing



4001 620



4032 620



4050 621



4216 621



4242 620



4242 622



4245 620



4245 621



4245 622



4256 620

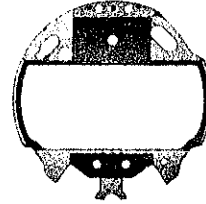

4408 620

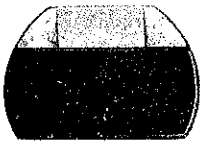

4501 620



4521 620



4540 620



SEIKO SB-BU

T	∞
022 257	022 468 $\frac{2}{1}$

Calibre No. 0439A		Jewels 0j	Style Name QUARTZ LC	
PART NO.	PART NAME	PART NO.	PART NAME	
4001 620	Circuit block			
4032 620	Bulb (with terminal)			
4050 621	Circuit bridge plate			
4216 621	Insulator for battery connection			
4242 620	Plus terminal of battery connection			
4242 622	Plus terminal of panel connection			
4245 620	Lock switch spring			
4245 621	Setting switch spring			
4245 622	Side setting switch spring			
4256 620	Crystal holding spring			
4408 620	Frame for liquid crystal panel			
4501 620	Liquid crystal panel (with C-MOS-LSI)			
4521 620	Reflecting mirror			
4540 620	Liquid crystal panel holder			
022 257	Circuit block screw			
022 257	Crystal holding spring screw			
022 257	Screw for plus terminal of battery connection			
022 257	Liquid crystal panel holder screw			
022 257	Circuit bridge plate screw			
022 468	Click pin			
SEIKO SB-BU	SEIKO genuine silver oxide battery			

TECHNICAL GUIDE

SEIKO DIGITAL QUARTZ

CAL.0439A

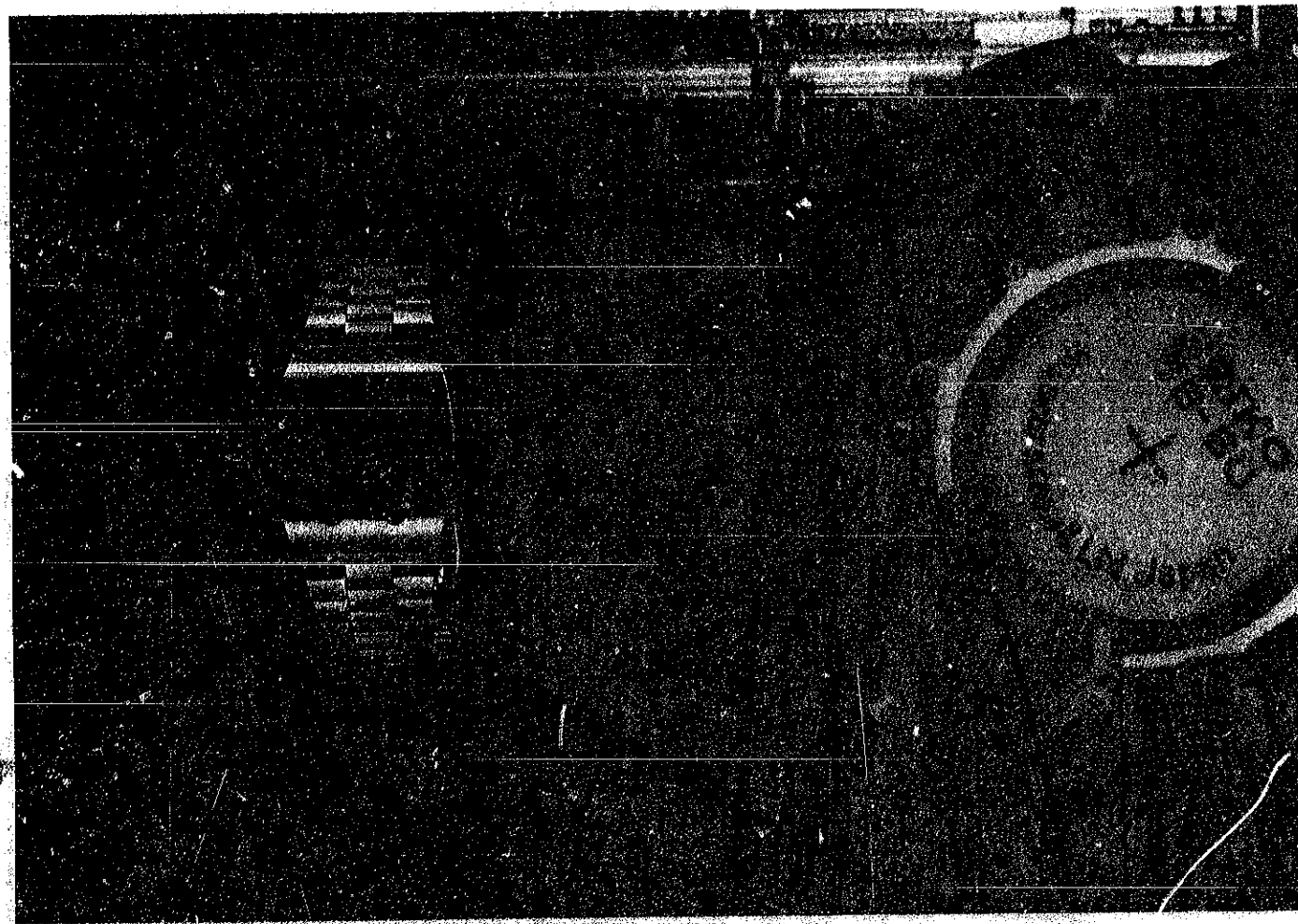

CONTENTS

I. SPECIFICATIONS AND FEATURES	1
1. Specifications	1
2. Features	1
II. HOW TO OPERATE THE BUTTONS	2
1. How to operate calendar	2
2. How to use the light	2
3. How to set the time and calendar	3
4. Remarks for battery replacement	4
III. DISASSEMBLING AND REASSEMBLING	5
1. After-sale servicing instruments and materials	5
2. Disassembling and reassembling of the case	6
3. Disassembling and reassembling of the movement and lubricating of the switch components	9
4. Cleaning	11
IV. CHECKING AND ADJUSTMENT	13
1. Guide table for checking and adjustment	13
2. Malfunction and checking points	14
3. Procedures for checking and adjustment	15
A. Check battery voltage	15
B. Check conductivity of liquid crystal panel and circuit block	15
C. Check liquid crystal panel and circuit block	16
D. Check current consumption	16
E. Check accuracy	16
F. Time accuracy adjusting	17
G. Check bulb condition	18
H. Check conductivity of switch components	18

Calibre 0439A

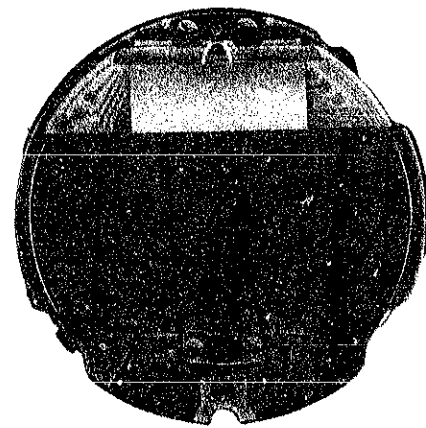

Time Function

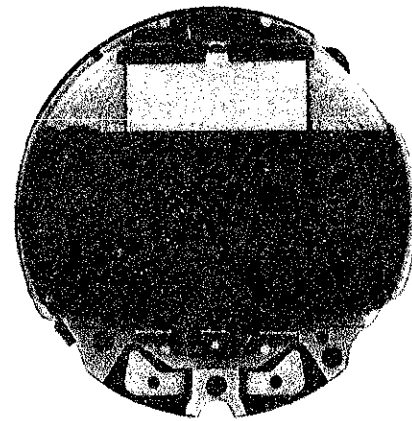

Calendar Function

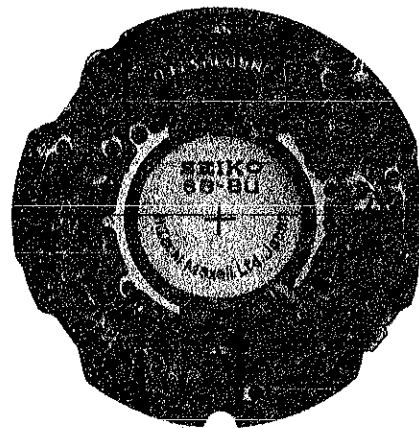

Movement

I. SPECIFICATIONS AND FEATURES

1. Specifications

Item	Calibre No.	0439A
Display system		Two-function changeover system <ul style="list-style-type: none"> • Time functions: Digital Display System showing hour, AM, PM, minute, and second Instant second resetting to "00" device • Calendar functions: Digital Display System showing month and date (upon command)
Display medium		Single Crystal Display (Nematic Liquid Crystal, FEM (Field Effect Mode))
Crystal oscillator		32,768 Hz. (Hz. = Hertz . . . cycle per second)
Loss/gain		Loss/gain at normal temperature range Mean monthly rate: less than 15 seconds (Annual rate: less than three minutes)
Casing diameter		φ27.0 mm
Height		5.5 mm
Operational temperature range		-10°C ~ +60°C (14°F ~ 140°F)
Regulation system		Trimmer condenser
Battery power		SEIKO genuine silver oxide battery (SB-BU) Battery life is over one year.
IC (Integrated Circuit)		C-MOS-LSI . . . 1 piece

2. Features

(1) Thin movement

New engineering techniques, including integration of MOS-IC and liquid crystal panel, has brought about this thin movement.

(2) With full practical functions

- 1) Digital Display of hour, AM/PM, minute and second
- 2) Digital Display of month and date (Automatic adjustment for the even and odd months)
- 3) Illuminating light illuminates the digital display in the dark
- 4) Select-and-set system for easy time adjustment
- 5) Automatic lock device to prevent the watch from being set by mistake

(3) Contains all excellent qualities and basic functions of 06 series

- 1) High-accuracy crystal oscillator
- 2) Simplified movement block for easy after-sale servicing
- 3) Clear display figures by using Single Crystal Display (Field Effect Mode Nematic Liquid Crystal)
- 4) Large legible display

II. HOW TO OPERATE THE BUTTONS

Time Function

FRONT-BUTTON TYPE

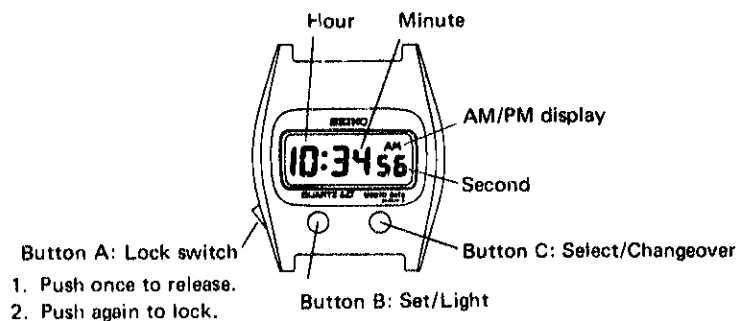

SIDE-BUTTON TYPE

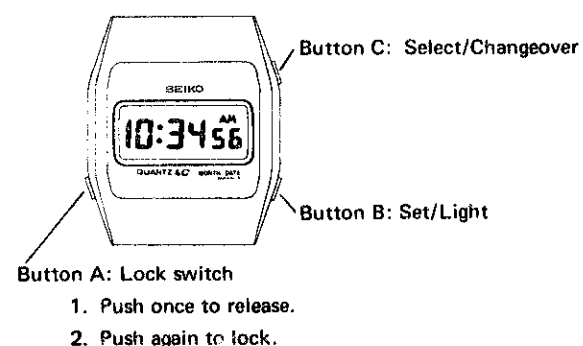

Calendar Function

FRONT-BUTTON TYPE

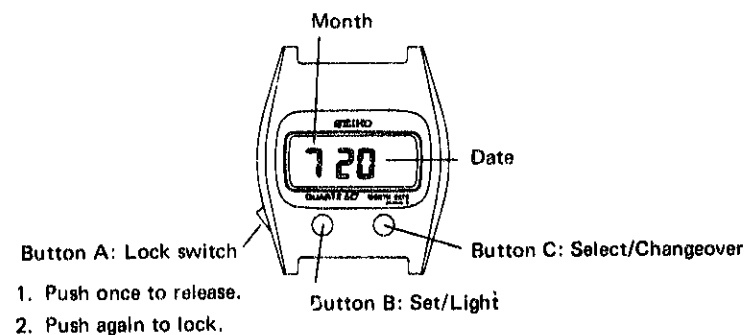

SIDE-BUTTON TYPE

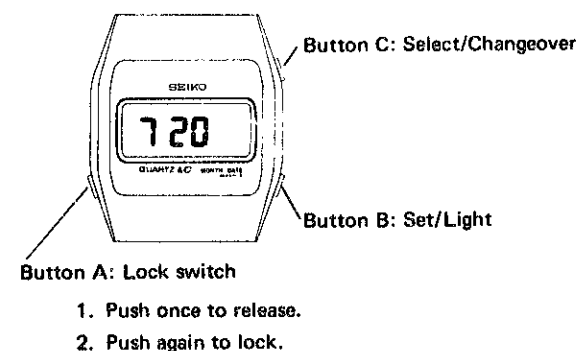

1. How to operate the calendar

While the time function digits are displayed, press button "C" and the calendar digits are immediately displayed. When button "C" is released, the time digits are again displayed.

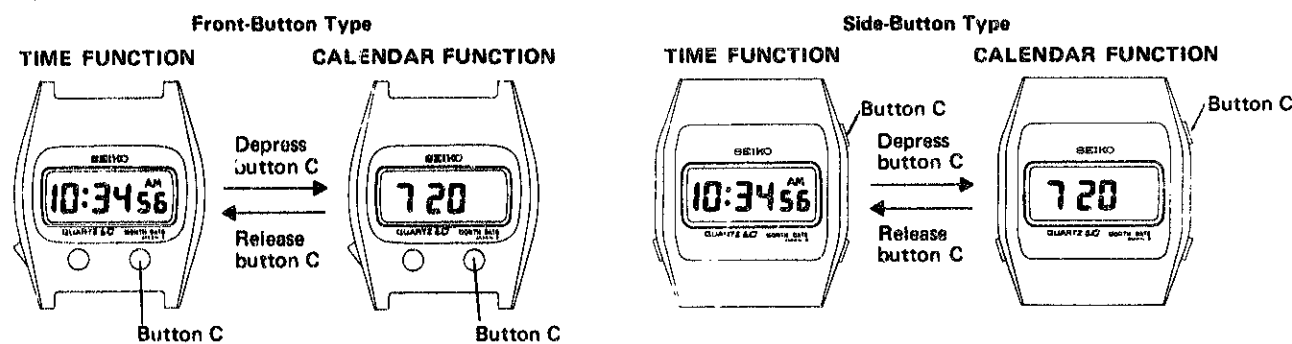

2. How to use the light

Depress button "B" and the light is lit while it is depressed. It illuminates the digital display in the dark.

Front-Button Type

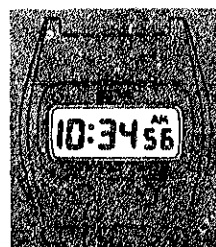

Light button (Button B)

Side-Button Type

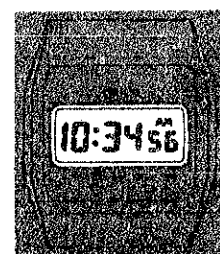

Light button (Button B)

3. How to set the time and calendar

Depress button "A", to unlock the time and calendar digits, and then each time button "C" is depressed the time and calendar digits will start flashing sequentially in the following order.

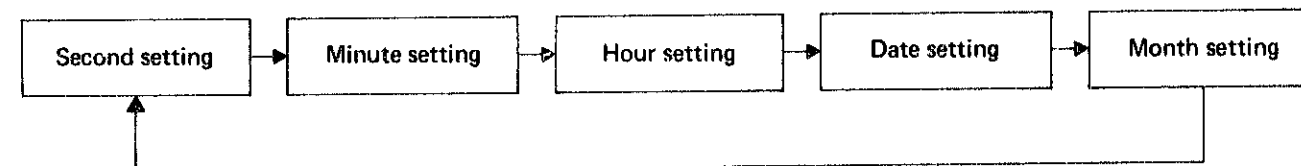

- When the lock position is released by depressing button "A", the second digits start flashing to indicate that they are ready to be adjusted.
- Depress button "C" in order to select which time and calendar digits are to be adjusted and depress button "B" to adjust the digits.
- After the adjustment is completed, depress button "A" again for it to be in the lock position.
- After any of the time digits are adjusted, always depress button "A" so that the digits will be in the lock position and cannot be set by accident.

[Example]

How to change the indication of 8:20.40 PM of the 25th, July into 10:00.00 AM of the 17th, August.

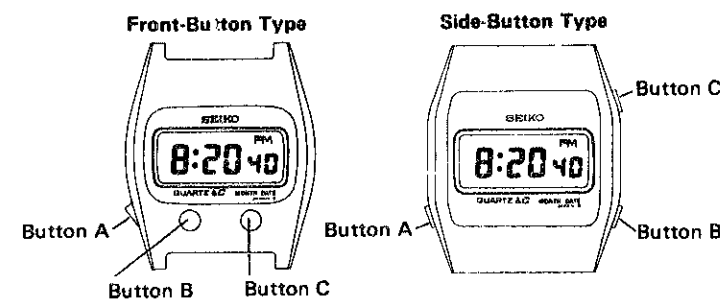

(1) Preparation for setting

Depress button "A" and the second digits will start flashing and that shows that the second setting is ready to be adjusted.

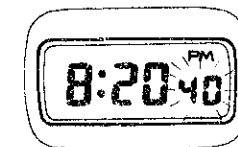

(2) Second setting

Depress button "B" in accordance with the "00" second of the time signal and the watch is then reset to "00" and starts immediately.

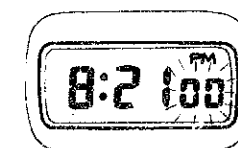

When the second setting is made between 30 and 59 seconds, one minute is added and the watch starts immediately from "00" second.

(3) Minute setting

Depress button "C" and the minute digits will start flashing. Now, one minute is advanced by each depression of button "B".

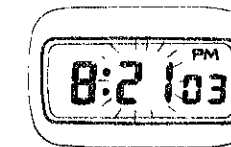

(4) Hour setting

Depress button "C" again and the hour digits will start flashing. Now, one hour is advanced by each depression of button "B".

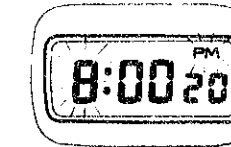

Note: Be sure that the time setting is made taking into account the "AM" or "PM" period so that the calendar will change at midnight.

(5) Date setting

Depress button "C" again and the time digits are automatically changed to the calendar digits and the date digits will start flashing.

Then, depress button "B" and one date is advanced by each depression.

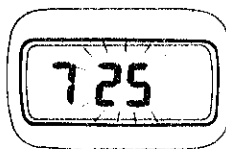

The date can be set up to 31 irrespective of whether it is the odd month or the even month. Even when 31 is set for the even month (30 or 31 is set for Feb.), the 1st day of the next month will automatically be displayed when the watch is in the lock position by depressing button "A".

(6) Month setting

Depress button "C" again and the month digits will start flashing. Now, one month is advanced by each depression of button "B".

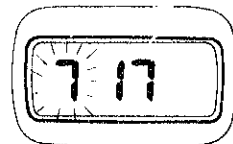

(7) Completion of setting



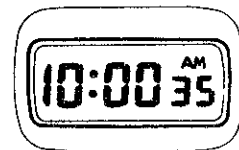

Now, all-time and calendar setting procedures have been completed. Depress button "A" for it to be in the lock position. This will lock the setting mechanism.



However, even if button "A" is not pushed back into the lock position after the time and calendar setting is completed, the locking device will automatically revert to the lock position within one or two minutes after button "B" or "C" is finally depressed.

4. Remarks for battery replacement

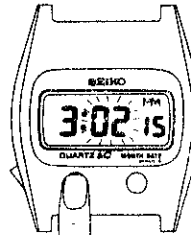
After the battery replacement, the following symptoms may appear. This is not a malfunction, adjust the digital display according to the procedures explained below.

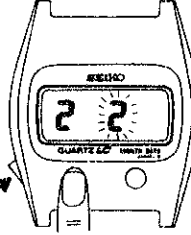
Symptom	Procedures
 <p>The digital display does not move.</p>	 <p>Depress button "A" (lock switch) and the digital display will begin functioning correctly.</p>
 <p>The watch may be set at the released position even if button "A" is not depressed in to release the watch.</p>	 <p>Adjust the digital display by depressing button "B" and "C" by following the "Time and calendar setting procedures".</p>
 <p>An unusual digital display is indicated.</p> <p>Example: 2 (Month) 0 (Date)</p>	 <p>Depress button "A" (lock switch), and adjust it by following the "Time and calendar setting procedures".</p>

III. DISASSEMBLING AND REASSEMBLING

1. After-sale servicing instruments and materials

For after-sale servicing of SEIKO Quartz Digital Cal. 0439A, the following instruments and materials are necessary.

(1) Quartz Tester QT-10 and QT-100

Used to check time accuracy (daily rate). The microphone is different, however, for QT-10 and QT-100.

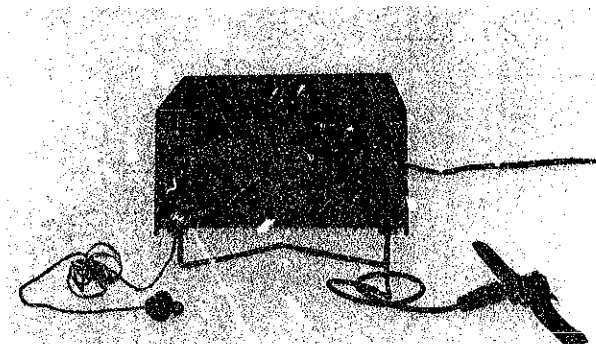

• Electric-field detection microphone for QT-10

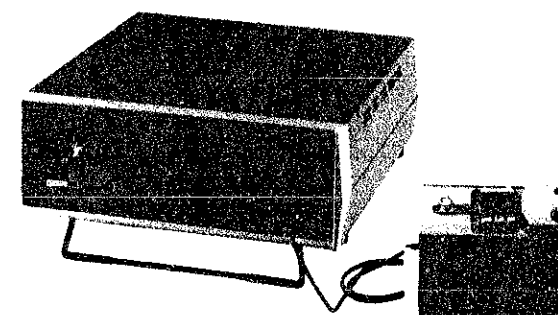

• Oscillation detection microphone for QT-100

(2) Volt-ohm-meter

Used to check battery voltage and measure current consumption.

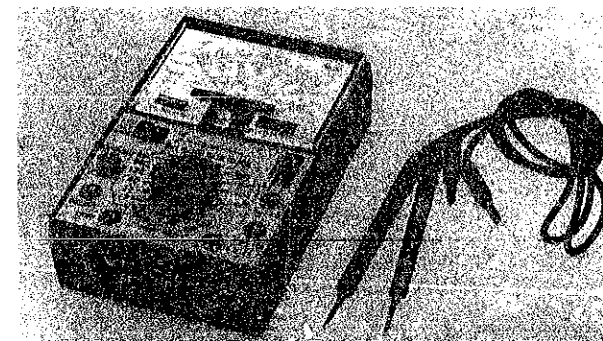

(3) Movement holder S-646

Used for disassembling and reassembling of the movement. (This movement holder is also used for Cal. 06 series.)



(4) Battery holding spring

Used for securing battery and flowing current when the movement is removed from the case.

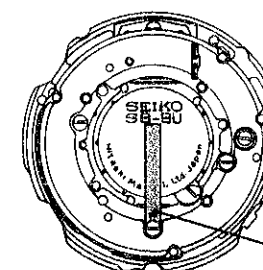
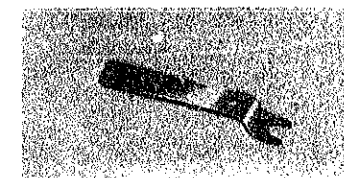

Battery holding spring

(5) Static electricity protector S-830

Used to protect the electronic circuit block of Digital Quartz from being damaged by static electricity.

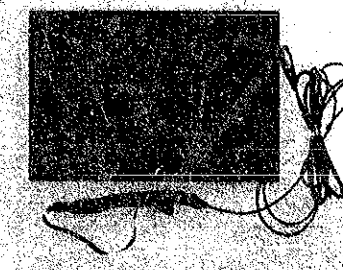

2. Disassembling and reassembling of the case

(1) Procedure

For the parts with double circles, refer to item (2), "Remarks for disassembling and reassembling" on page 7 and 8.

[Example] 0439-5009

Disassembling procedures Figs.: ① ~ ⑦

Reassembling procedures Figs.: ⑦ ~ ①

Lubricating ∞ : SEIKO Watch Oil, S-6, normal quantity

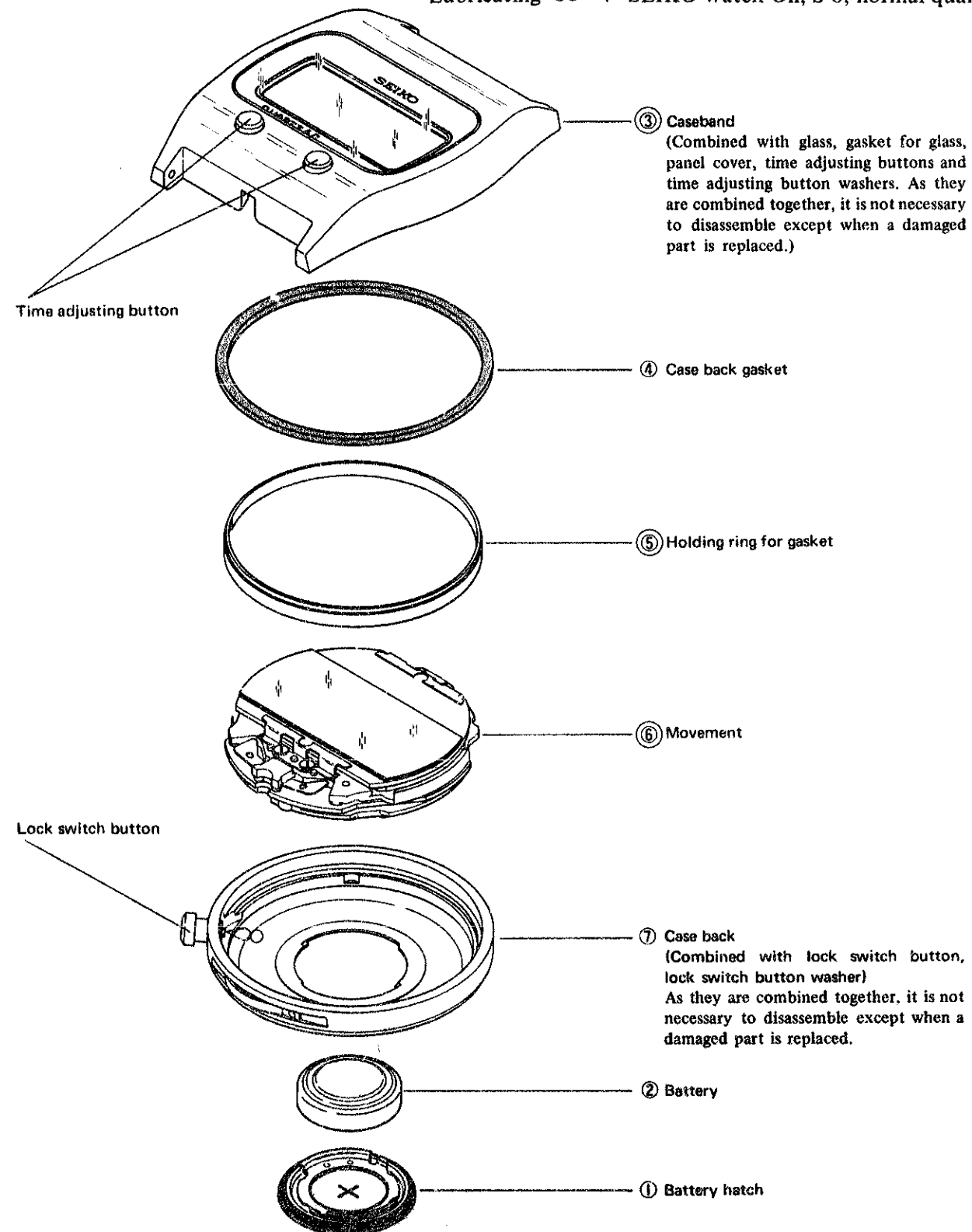

(2) Remarks for disassembling and reassembling of the case

● How to remove the caseband ③

It is combined with the glass, gasket for glass, panel cover, time adjusting buttons and time adjusting button washers. While pushing the two leaf springs of the case back with tweezers, move them toward the case back side.

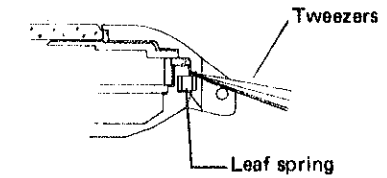
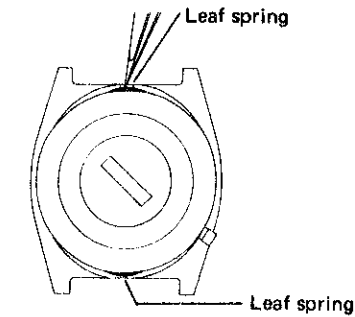

● How to remove and replace the glass

It is required only when the glass is replaced with a new one. Use the tightening tool (S-220).

Disassembling

Remove the glass with the inserting disk which is contained in the S-160 disk unit.

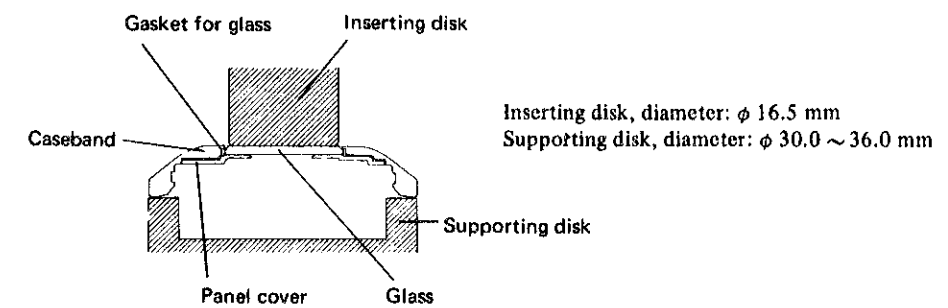

Do not push the glass in the center but rather left and right with the inserting disk while moving the caseband. This will enable to remove the glass without damaging the panel cover.

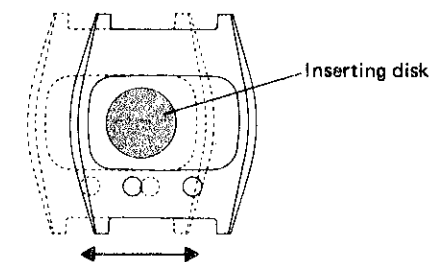

Reassembling

1. Fix the gasket for glass

Fix the gasket in the groove. (Do not apply silicone grease on it.)
Pay careful attention to the front and back sides of the gasket.

2. Set the glass

Pay careful attention to the obverse and reverse of the glass.

3. Set the panel cover

Place the panel cover on the caseband so that its time adjusting buttons are fixed into the holes of the panel cover. Be sure to check from the front side that the panel cover is set in the correct position.

4. Set the panel cover (Use the tightening tool S-220)

Place the inserting disk on the panel cover so that it doesn't touch the time adjusting button pipe. (Place a vinyl sheet between the watch and supporting disk so as not to scratch the watch.)

Inserting disk, diameter: ϕ 26.5 mm
Supporting disk, diameter: ϕ 27.0 ~ 30.0 mm

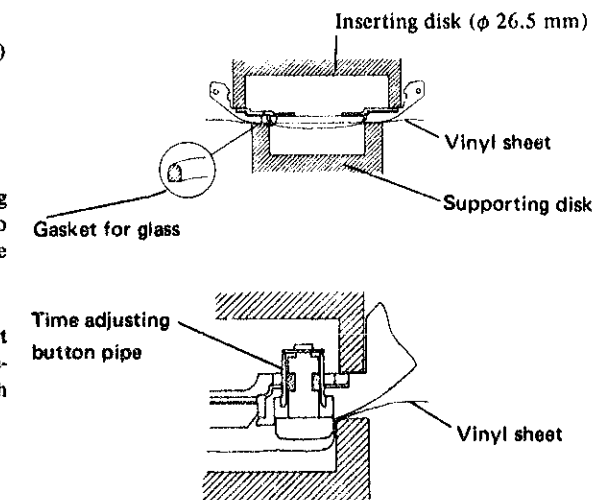

• How to reassemble the case

Movement ⑥

Set the movement in the case back with button "A" (lock switch) pulled out.

If the movement is set in the case back with button "A" (lock switch) depressed in, it prevents the movement from being set in the case back.

Be sure that the two protrusions of the circuit block are fixed into the grooves of the case back.

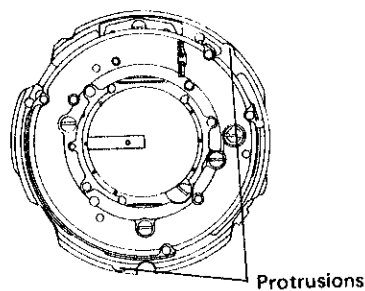
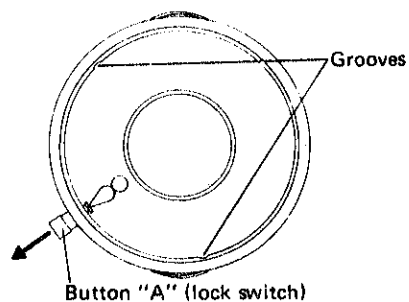

Holding ring for gasket ⑤

Mount the holding ring for gasket so that its groove is placed on button "A" (lock switch).

After mounting the holding ring for gasket, depress button "A" (lock switch) to check if the button can be pushed in.

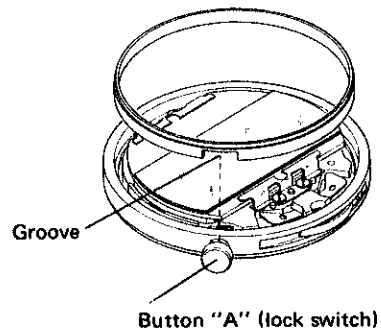

Caseband ③

1. After the case back gasket ④ is set, place the assembly on the table.
2. Set the caseband on the assembly evenly directly from above. The cut of the caseband is placed on button "A" (lock switch).

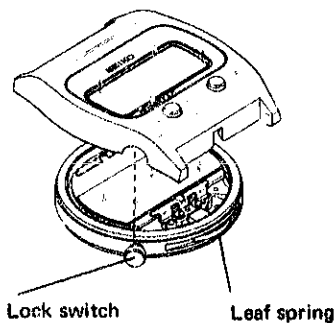

3. Push the leaf springs (2 places) with tweezers to fix them to the caseband.

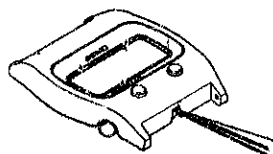

3. Disassembling and reassembling of the movement and lubricating of the switch components.

Disassembling procedures Figs.: ① ~ ⑱

Reassembling procedures Figs.: ⑱ ~ ①

Lubricating ∞ : SEIKO Watch Oil, S-6, normal quantity

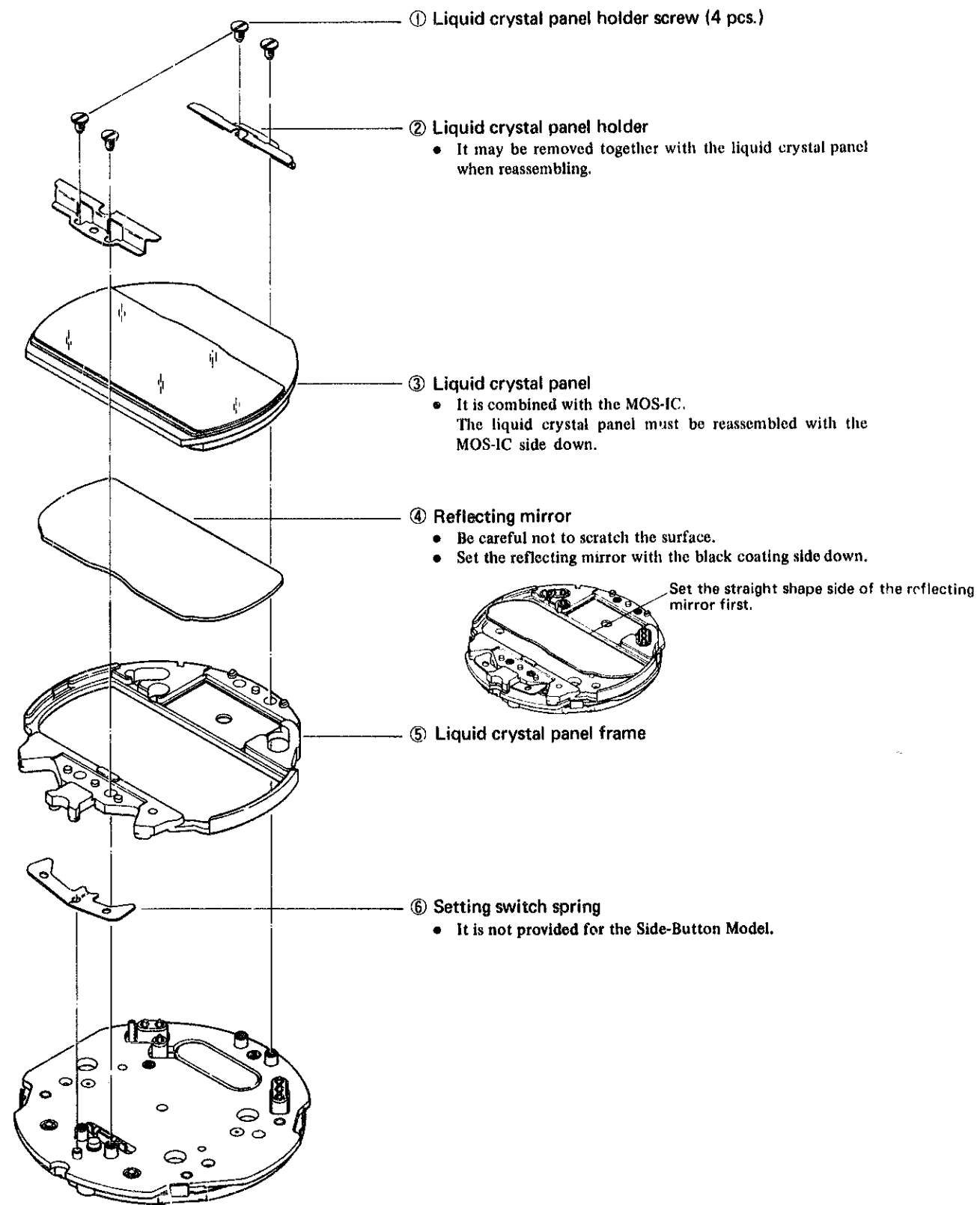

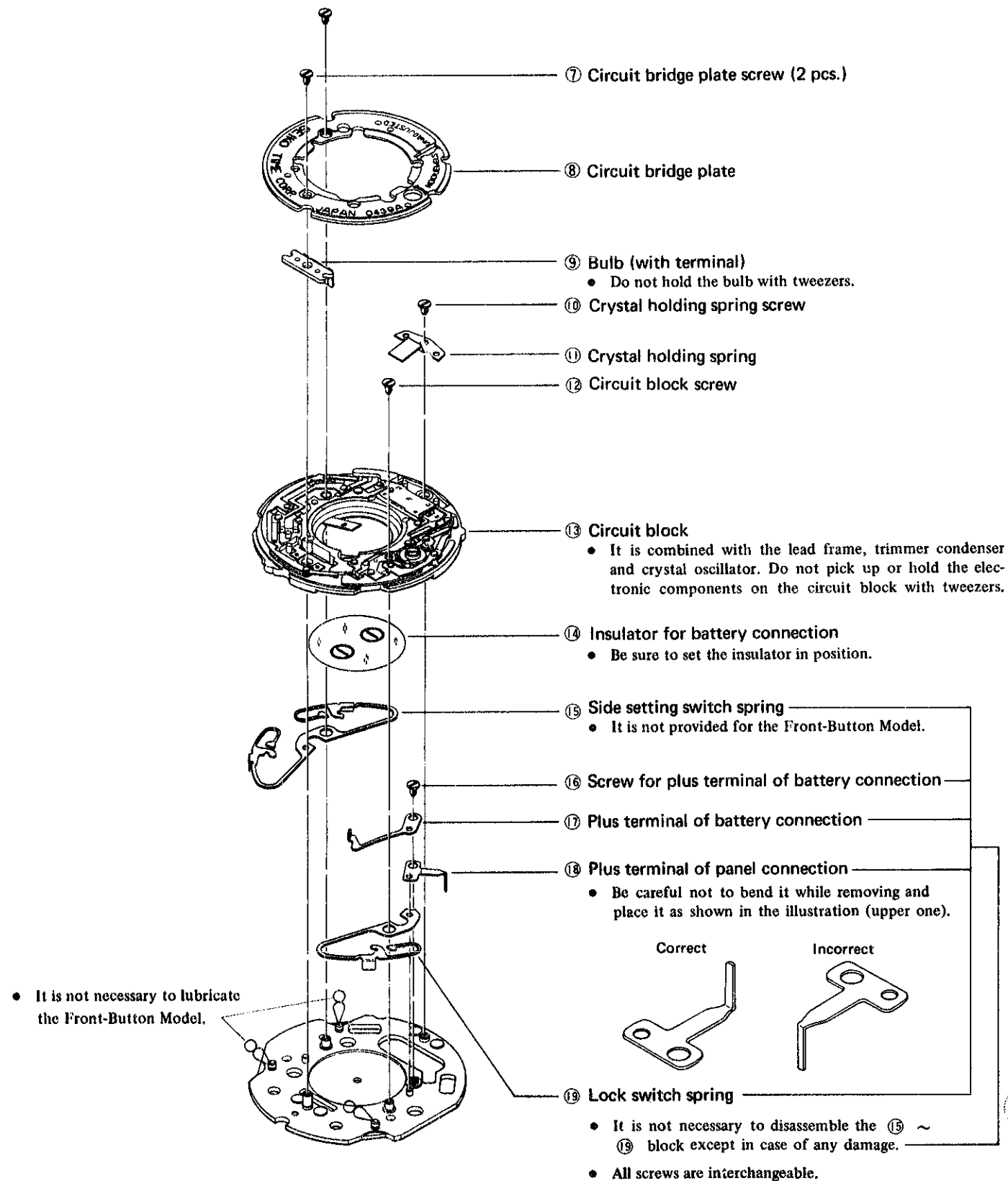

4. Cleaning

Since several special parts of Cal. 0439A, differ from the conventional mechanical watches, use the following method when cleaning.

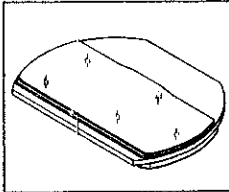
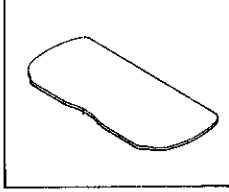
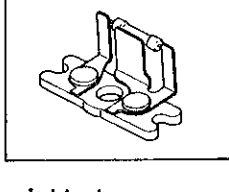
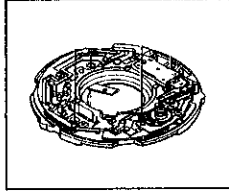
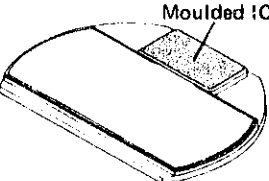
Name of part	Cleaning	Drying	Solution	Remarks
(1) Liquid crystal panel  Reflecting mirror  Bulb  Circuit block 	DO NOT CLEAN			<ul style="list-style-type: none"> Wipe dust and lint with a soft brush. Clean the liquid crystal panel electrodes with a cloth moistened with benzine or alcohol. Be careful not to touch the moulded IC with the cloth. 
(2) Plastic parts (Liquid crystal panel holder, liquid crystal panel frame, circuit bridge plate, insulator for battery connection)	Rinse or gently scrub with a brush	Cool air	Benzine, or alcohol	
(3) Parts other than above	Clean with cleaner, rinse or gently scrub with a brush	Cool air or hot air	Trichloroethylene, benzine or alcohol	

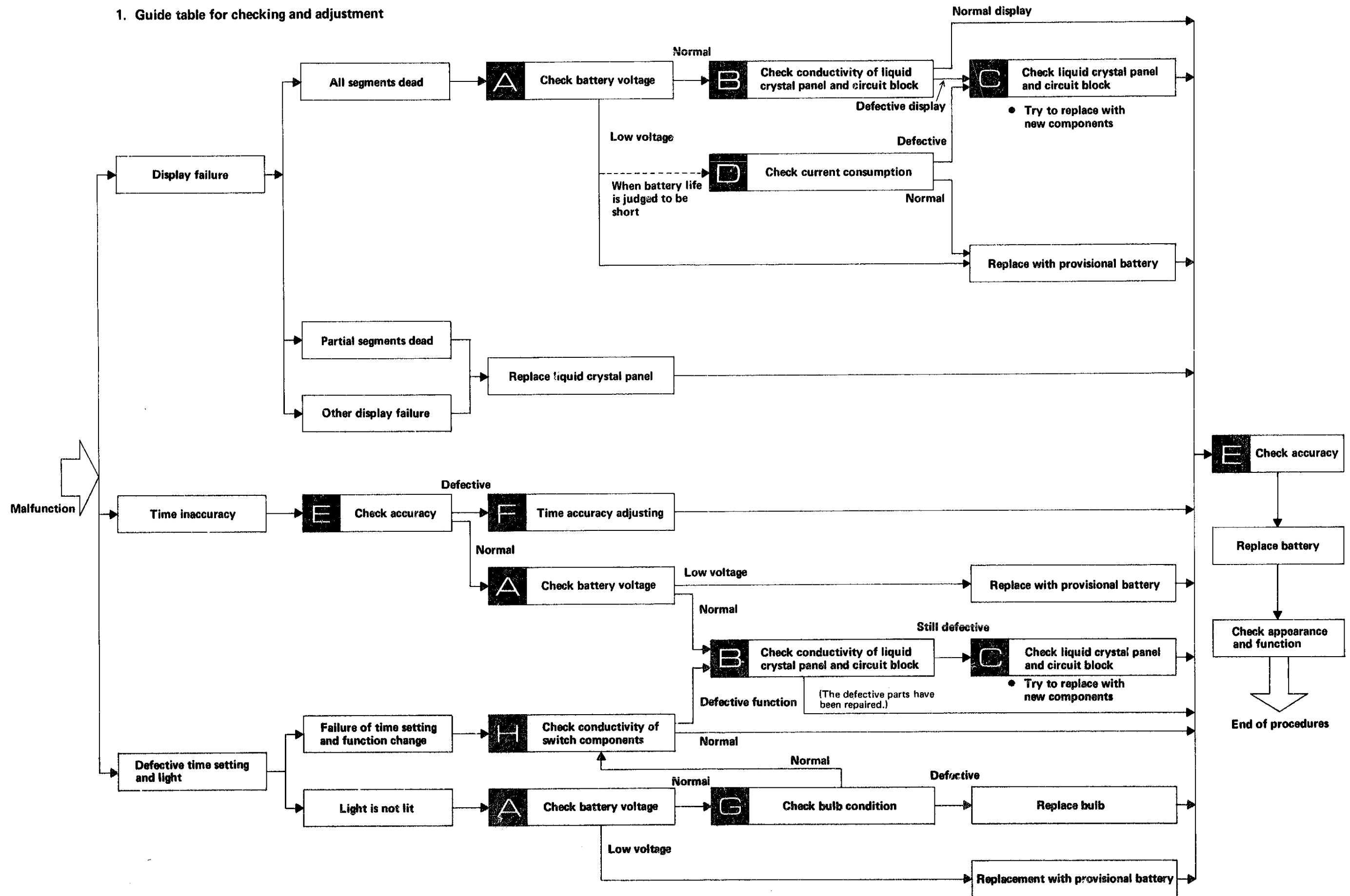

IV. CHECKING AND ADJUSTMENT

1. Guide table for checking and adjustment

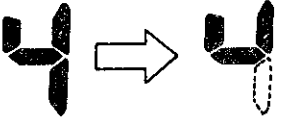

2. Malfunction and checking points

- Check in the numerical order
- Refer to "Guide table for checking and adjustment" on page 13.

FAULTY SYMPTOMS		CHECKING POINTS						
		A	B	C		F	G	H
		Battery Voltage	Contact of Liquid crystal panel and circuit block	Liquid crystal panel	Circuit block	Time accuracy adjusting	Bulb	Switch components
DISPLAY FAILURE	No digital display, dim digital display or extremely slow response.	①	②	③	④			
	Segment dead One or a few segments are not lighted or dim. <i>Example:</i> 			①	②			
	Other defective appearance (Deflection) Some or all of one segment show different contrast depending on the direction of view. <i>Example:</i>  (Poor appearance) Some portions of the liquid crystal panel will have air bubbles or iridescent view. <i>Example:</i> 			①	②			
TIME INACCURACY	Gain or loss tested by Quartz tester.					①		
	Though Quartz tester indicates the normal figures, a watch gains or loses when it is worn on the wrist.	①	②	③	④			
DEFECTIVE TIME AND CALENDAR SETTING OR LIGHT	Failure of time and calendar setting or changeover of time and calendar display.		②	③	④			①
	Light is not lit or light is lit but dims soon.	①	④				②	③

3. Procedures for checking and adjustment

A CHECK BATTERY VOLTAGE

Use the following procedures to check battery voltage.

- (1) Set up the Volt-ohm-meter
Range to be used: DC 3V
- (2) Measuring
 - Probe Red (+) Battery surface (+)
 - Probe Black (-) Battery surface (-)

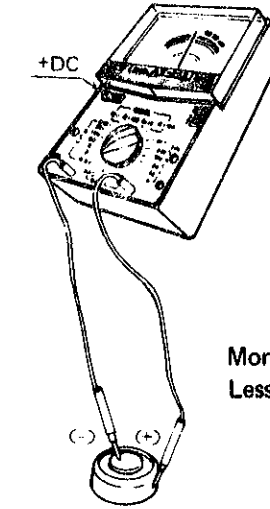

More than 1.5V . . . Normal
Less than 1.5V . . . Defective

B CHECK CONDUCTIVITY OF LIQUID CRYSTAL PANEL AND CIRCUIT BLOCK

- (1) Check to see if the circuit bridge plate screw, circuit block screw, and crystal holding spring screw are loose.

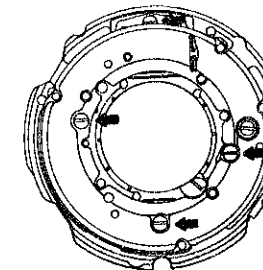

Check to see if the four screws shown in the illustration are loose, and if they are loose, retighten them.

- (2) Check conductivity of the liquid crystal panel and the circuit block.

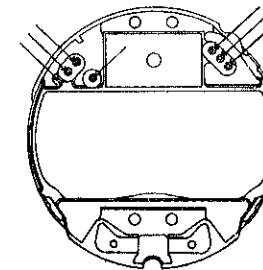

Check the conductivity of the seven terminals of the circuit block and the seven electrodes of the liquid crystal panel.

1. Remove the liquid crystal panel holder and check the contact conditions through a microscope. Look in through the direction of the arrow shown in the illustration.

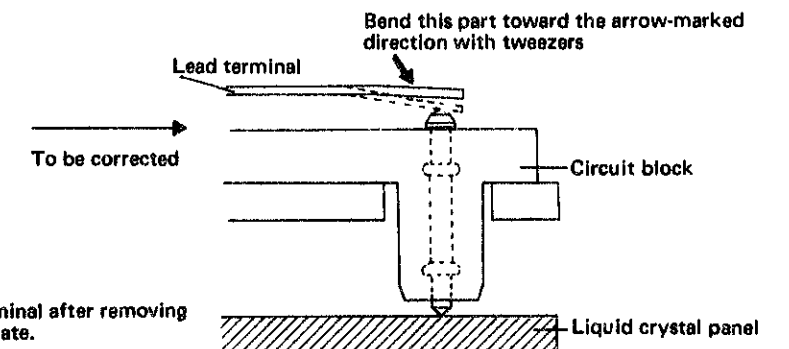
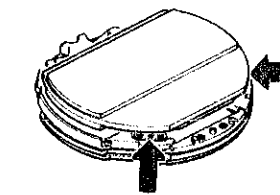
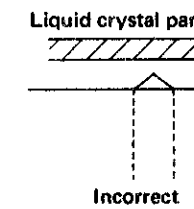
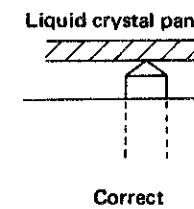

- Adjust the lead terminal after removing the circuit bridge plate.

2. After removing the liquid crystal panel, check to see if there is any contamination, dust or lint on the connecting portions of the liquid crystal panel and the circuit block.

Note: When the connecting portion of the liquid crystal panel is cleaned with a cloth moistened with benzine, be careful not to touch the moulded IC with the cloth.

C CHECK LIQUID CRYSTAL PANEL AND ELECTRONIC CIRCUIT BLOCK

Replace the liquid crystal panel and the circuit block with new ones, and check if the watch functions correctly.

D CHECK CURRENT CONSUMPTION

Check if the current consumption is normal.

How to measure

• **Volt-ohm-meter**

Place the battery on the case back with its minus side up.
 Black probe (-) Minus side of the battery
 Red probe (+) Battery connection

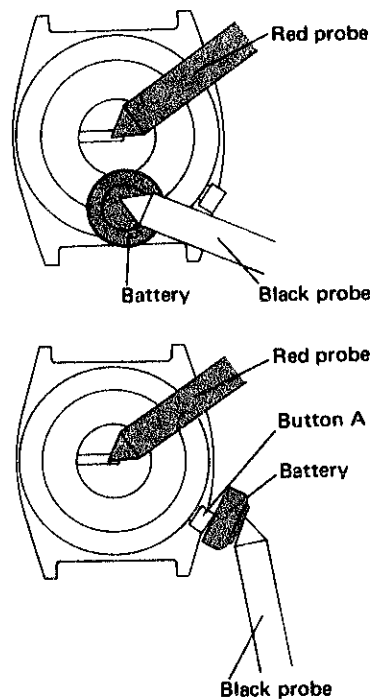

If the current consumption cannot be measured with the above method, touch the battery to button "A" and the black probe should be touched to the battery.

Less than 3.5 μ A: . . . Normal
 More than 3.5 μ A: . . . Defective

E CHECK ACCURACY

- Use the electric-field detection microphone for QT-10. (See "How to use Quartz Tester QT-10" of the Technical Guide for Cal. 0624A, page 6.)
- Use oscillation detection microphone for QT-100.

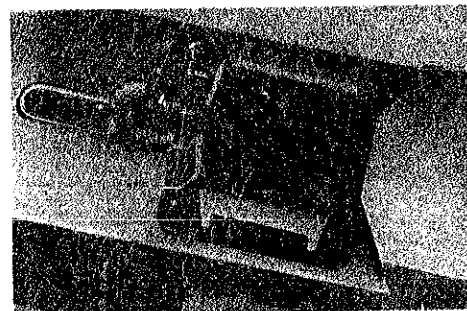
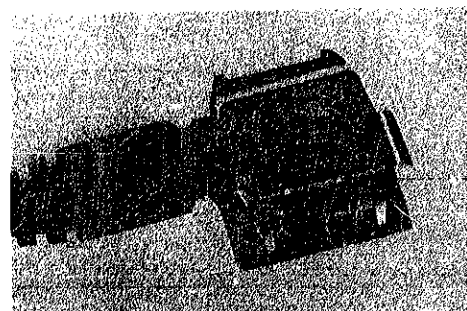

F TIME ACCURACY ADJUSTING

Time accuracy of Cal. 0439A is adjusted by turning the trimmer condenser.

• **Adjusting method**

The watch will gain or lose according to the direction in which the trimmer condenser is turned. Adjustment should therefore be made after ascertaining with the Quartz Tester whether the watch tends to gain or lose.

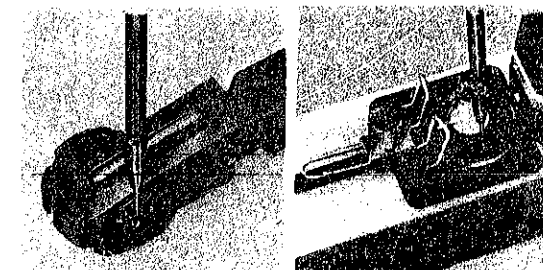

• **Note for handling the trimmer condenser**

Avoid excessive depressing and turning of the trimmer condenser.

• **Function of the Trimmer Condenser**

The trimmer condenser consists of a rotor electrode and a stator electrode as shown in the diagram. Turning the shaft fixed to the rotor changes the overlapped area between the stator electrode and rotor electrode, which in turn changes the capacity of the trimmer condenser.

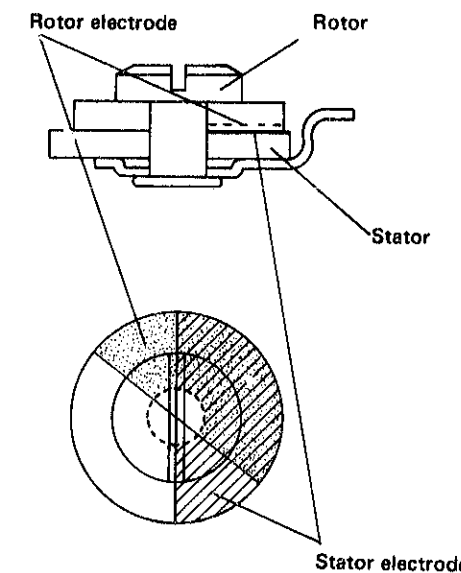

• **Change in the capacity of trimmer condenser and the adjusting accuracy rate.**

Turning the trimmer condenser changes its capacity as shown in the diagram.

The trimmer condenser has been so adjusted at the factory so as to let the watch gain when it is turned clockwise and vice versa. Whenever adjustment is needed, however, turn the trimmer condenser while examining the gain and loss by the Quartz Tester.

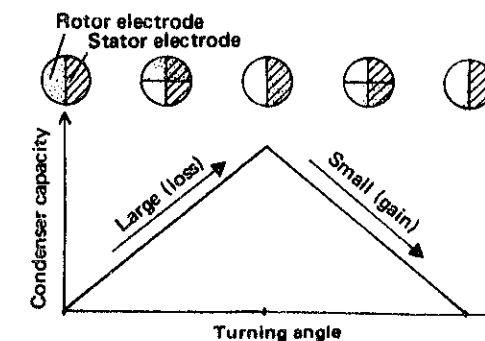

G CHECK BULB CONDITION

Check to see if there is a broken filament in the bulb and disconnection of welded terminal.

(1) Set up the Volt-ohm-meter

Range to be used: Ohms Γ : 1

(2) Check

Touch the two probes to the bulbs as shown in the illustration (there is no difference between the red and black probes).

Light is lit: Normal

Light does not light: . . Defective (Replace the bulb.)

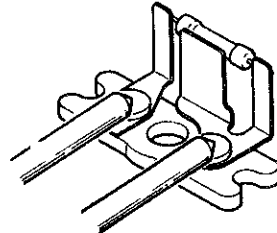

H CHECK CONDUCTIVITY OF SWITCH COMPONENTS

Check to see if the lock switch spring, setting switch spring and side setting switch spring function correctly.

Check them after removing the liquid crystal panel holder, liquid crystal panel, reflecting mirror and the liquid crystal panel frame.

(1) Check to see if the switch components work correctly.

(Check with a microscope)

Front-Button Type . . . check A, B' and C'

Side-Button Type check A, B and C

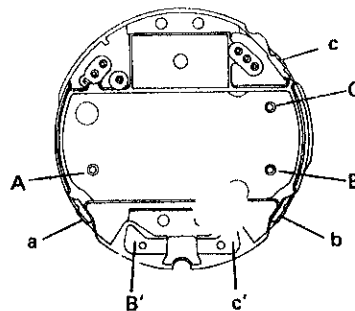

1. Side switch (A, B & C)

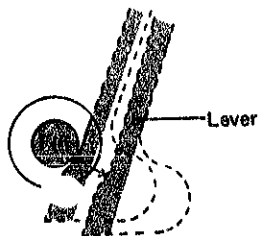

The lever should touch the pin when the lock switch spring and the side setting switch spring are depressed strongly (depress a, b and c) and the lever should be removed from the pin when they are released.

("a" corresponds with "A", "b" → "B" and "c" → "C".)

2. Front switch (B' & C')

The setting switch spring should touch the pin when it is pushed toward the direction marked by the arrow and it should be removed from the pin when released.

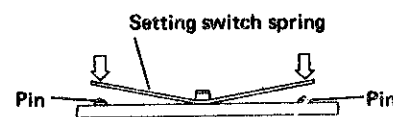

Check to see if there is any contamination, dust or lint on the connecting portions, and clean the connecting portion.

When the switch spring does not move smoothly, replace it with a new one.

All procedures of Disassembling and Reassembling, and Checking and Adjustment are completed.