

SEIKO

QUARTZ LC

(Cal.0124A)

PARTS LIST

Calibre No. <h1 style="text-align: center;">0124A</h1>	Jewels <h1 style="text-align: center;">0j</h1>	Style Name <h1 style="text-align: center;">QUARTZ LC</h1>
--	--	---

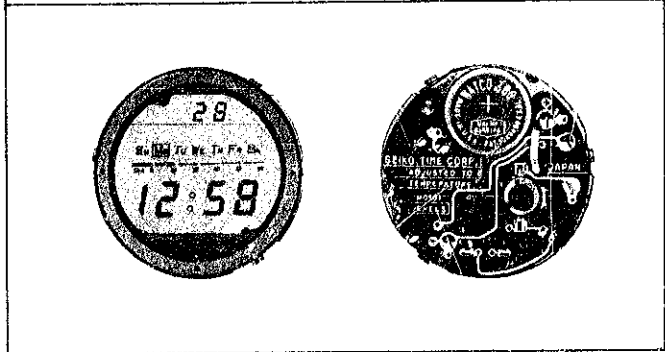

Characteristics

Casing diameter : 28.00 ϕ mm
Maximum height : 8.00 mm
Frequency of quartz crystal oscillator : 32,768 Hz
(Hz = Hertz Cycle per second)

Time display : 12-hour Digital Display System showing day, date, hour and minute
10-second unit indicator
 \odot for AM; \ominus for PM
(cc'lon between hour digit and minute digit changes as above)
Single Crystal Display (Nematic Liquid Crystal, FE-type)

Operation : System selection and digit adjustment are operated by only turning the crown.
Time micro-adjustor : Trimmer condenser system
Illumination light for digital panel : Illuminated in coordination with the crown depressing

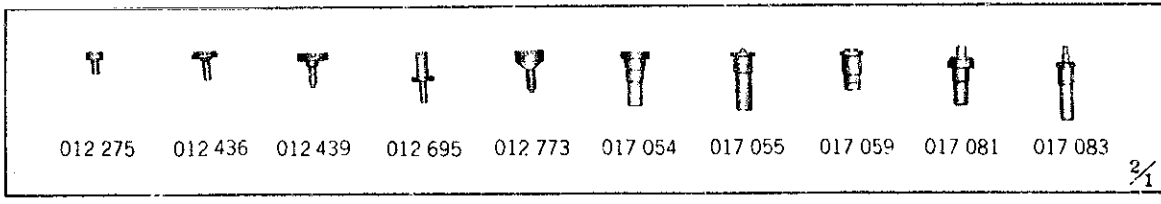
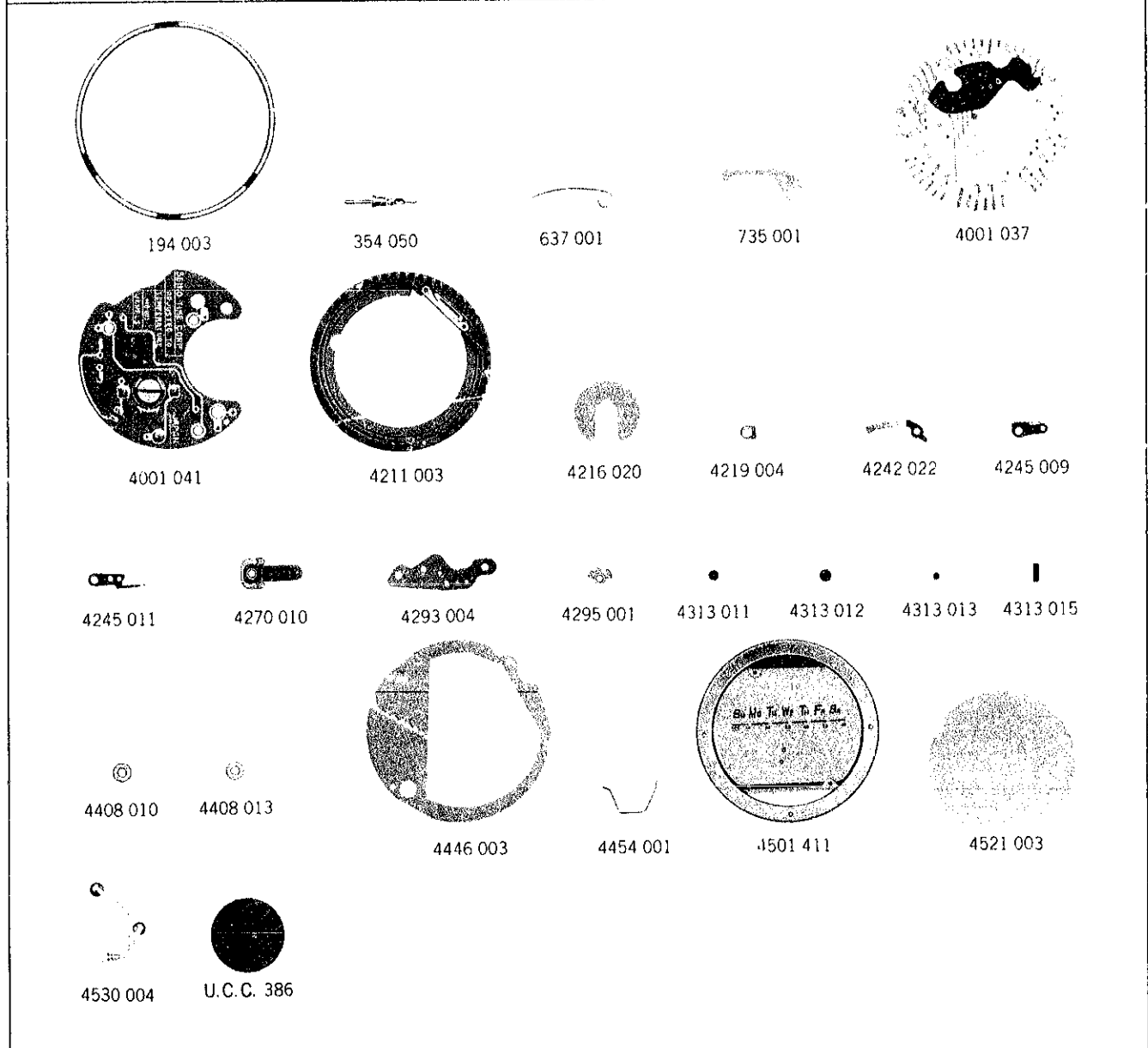

Calibre No.		Jewels	Style Name	
0124A		0j	QUARTZ LC	
PART NO.	PART NAME	PART NO.	PART NAME	
194 003	Holding ring for movement			
354 050	Digit adjusting stem			
637 001	Stem setting spring			
735 001	Digit adjusting stem holder			
4061 037	Circuit block (A)			
4001 041	Circuit block (B)			
4211 003	Connector ring with connector (D)			
4216 020	Insulator for battery			
4219 004	Insulator (A)			
4242 022	Plus terminal of battery connection			
4245 009	Switch spring (A)			
4245 011	Switch spring (B)			
4270 010	Battery connection			
4293 004	Switch cock			
4295 001	Switch cam			
4313 011	Connector (C)			
4313 012	Connector (A)			
4313 013	Connector (B)			
4313 015	Connector (D)			
4408 010	Insulating spacer (B) for circuit block			
4408 013	Insulating spacer (A) for circuit block			
4446 003	Insulating seat			
4454 001	Switch cam spring			
4501 411	Liquid crystal panel (with frame)			
4521 003	Reflecting mirror			
4530 004	Bulb (with terminal)			
012 275	Screw for switch spring (B)			
012 436	Switch cock screw			
012 436	Screw for circuit block (B)			
012 439	Digit adjusting stem holder screw			
012 695	Stem unlocking screw			
012 773	Liquid crystal panel screw			
017 054	Tube for battery connection screw			
017 055	Tube (A) for circuit block screw			
017 059	Tube (B) for switch cock screw			
017 081	Tube (A) for switch cock screw			
017 083	Tube (B) for circuit block screw			
U.C.C. 386	Silver oxide battery			

TECHNICAL GUIDE

SEIKO
QUARTZ

CAL.0124A

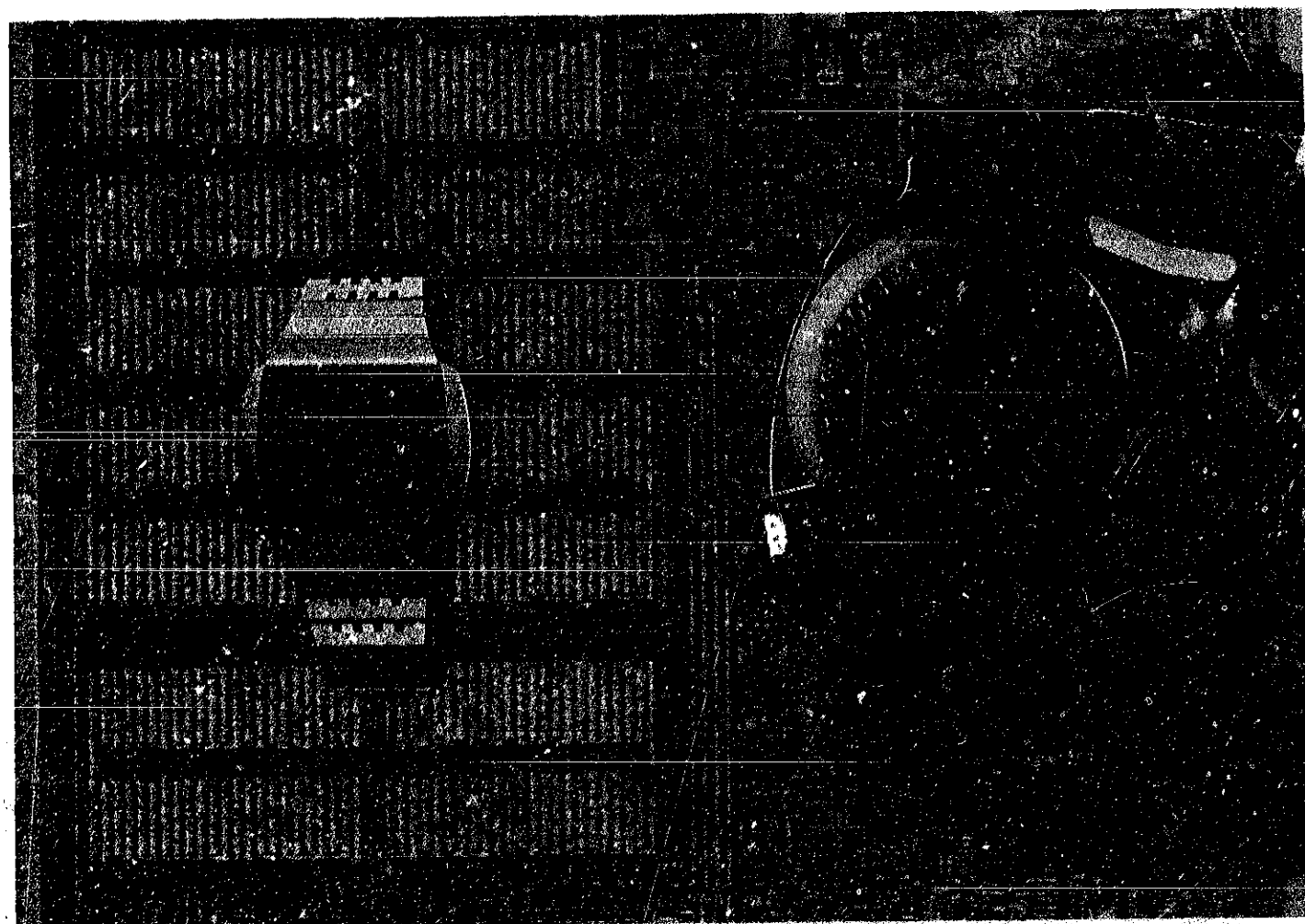

CONTENTS

I. Specifications	1
II. Outline of functioning	2
III. How to set the time and date	3
IV. Disassembling and reassembling	5
1. After-servicing instruments and materials	5
2. Disassembling and reassembling of the case	6
3. Disassembling and reassembling of the movement and lubricating of the switch components	8
4. Cleaning	12
V. Checking and adjustment	13
1. Guide for checking and adjustment	13
2. Malfunction and checking points	14
3. Procedures for checking and adjustment	15
A. Check battery voltage	15
B. Check circuit block (B) conductivity	15
C. Check conductivity of liquid crystal panel, connector ring and circuit block (A)	15
D. Check setting mechanism	17
E. Check bulb condition	18
F. Check current consumption	18
G. Check accuracy	18
• Time accuracy adjusting	19
H. Check functioning	20
4. Packing and maintenance of the spare parts	21

Calibre 0124A

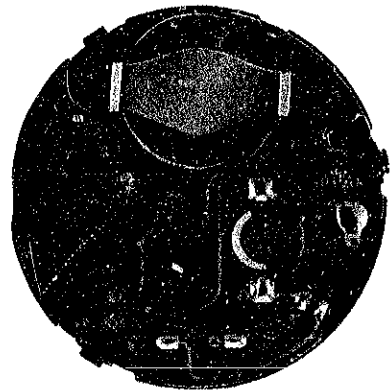
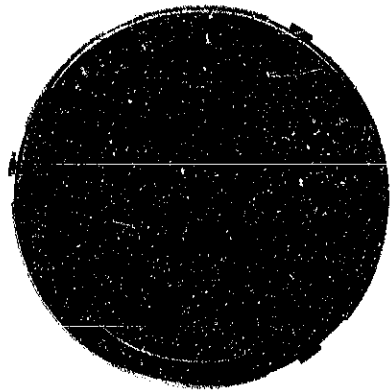

Movement

I. SPECIFICATIONS

1. Specifications

Items	Calibre No. 0124A										
Display medium	Single Crystal Display (Nematic Liquid Crystal, FE (field effect)-type)										
Display system	<table border="0"> <tr> <td style="text-align: center;">DISPLAY</td> <td style="text-align: center;">DISPLAY METHOD</td> </tr> <tr> <td>Date, hour, minute:</td> <td>12-hour Digital Display System</td> </tr> <tr> <td>Second:</td> <td>10-second unit indicator</td> </tr> <tr> <td>Day:</td> <td>Moving frame indicator</td> </tr> <tr> <td>AM · PM:</td> <td>☉ for AM; ☿ for PM (colon between hour digit and minute digit changes as above)</td> </tr> </table>	DISPLAY	DISPLAY METHOD	Date, hour, minute:	12-hour Digital Display System	Second:	10-second unit indicator	Day:	Moving frame indicator	AM · PM:	☉ for AM; ☿ for PM (colon between hour digit and minute digit changes as above)
DISPLAY	DISPLAY METHOD										
Date, hour, minute:	12-hour Digital Display System										
Second:	10-second unit indicator										
Day:	Moving frame indicator										
AM · PM:	☉ for AM; ☿ for PM (colon between hour digit and minute digit changes as above)										
Operation	<p>System selection and digit adjustment are operated by only turning the crown.</p> <p>Push the crown in at the normal position: Illumination light</p> <p>Crown at normal position: Lock</p> <p>Pull out crown to first click: System selection for selecting which digits are to be adjusted (turn clockwise—away from you)</p> <p>Digits adjustment (turn counterclockwise—towards you)</p>										
Crystal oscillator	32,768 Hz. (Hz. = Hertz . . . Cycles per second)										
Loss/gain	<p>Loss/gain at normal temperature</p> <p>Mean monthly rate: Less than 10 seconds (Less than 2 minutes a year)</p> <p>Temperature compensation device</p>										
Casing diameter	φ 28.0 mm										
Height	8.0 mm										
Operational temperature range	-10°C ~ +60°C (14°F ~ 140°F)										
Regulation system	Trimmer condenser										
Battery power	Silver oxide battery (U.C.C. 386) Battery life is over one year										
IC (Integrated Circuit)	<p>Oscillation & Frequency Divider Circuit: C-MOS-IC . . . 1 pce.</p> <p>Decoding & Driving Circuit: C-MOS-LSI . . . 2 pcs.</p>										

II. OUTLINE OF FUNCTIONING

SEIKO Digital Quartz Cal. 0124A consists of the following five blocks.

1. Oscillator, frequency divider and up-converter circuits

1) Crystal oscillator

When voltage is supplied to the crystal oscillator, it oscillates accurately at 32,768 Hz.

2) Oscillator circuit

The oscillator circuit supplies energy to the crystal oscillator and takes out oscillations (electric signal) and converts them into impulses.

3) Frequency divider circuit

The frequency divider circuit receives 32,768 Hz. oscillations from the oscillator circuit and it converts them into the proper impulses, i.e., 1/2, 1/2, 1/2 for liquid crystal display.

4) Upconverter circuit

The upconverter circuit steps up the battery voltage (1.5V) up to a level enabling the liquid crystal to function.

2. Decoding and driving circuit

The electric signal transmitted from the frequency divider circuit is properly arranged and converted into the suitable impulses for driving the display mechanism.

3. Connector ring

The connector ring transfers electric signal transmitted from the decoding and driving circuit to the liquid crystal panel.

4. Liquid crystal panel

The liquid crystal panel receives electric signal transmitted from the driving circuit and indicates the time precisely.

5. Lock switch (setting crown)

The lock switch (setting crown) is connected to the decoding and driving circuit and light, and used for the time adjusting and the illuminating light.

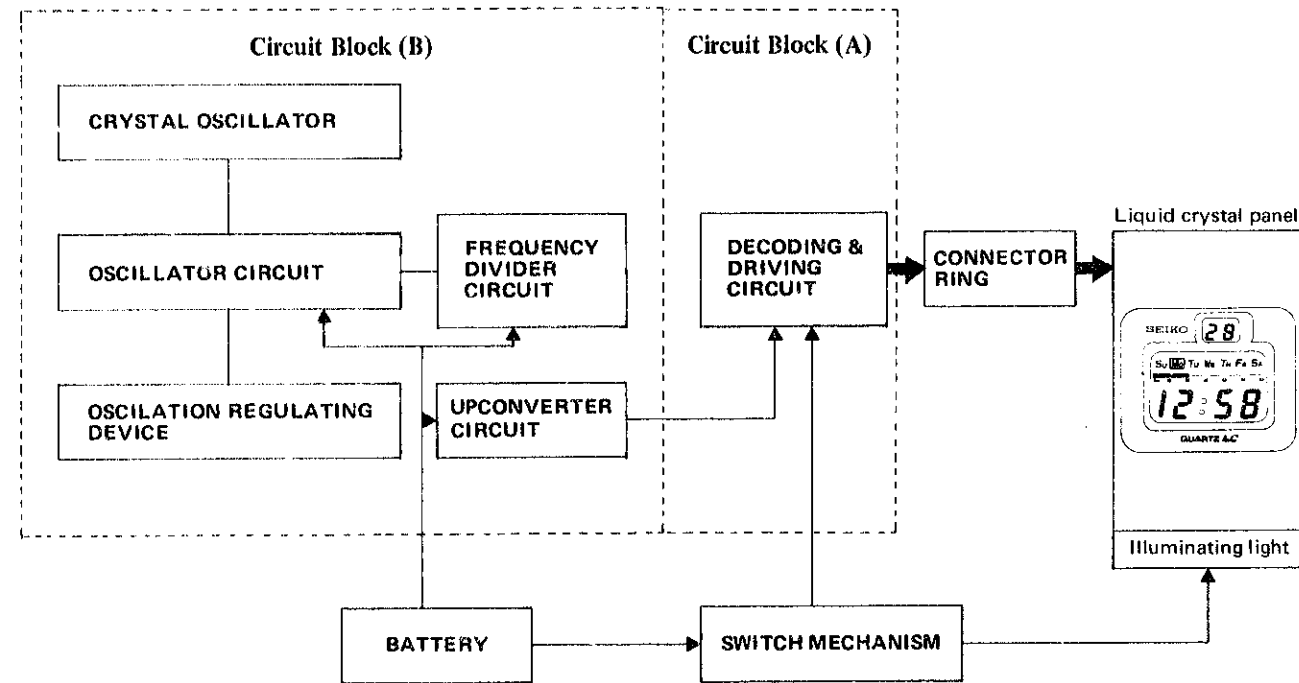

III. HOW TO SET THE TIME AND DATE

1. Display

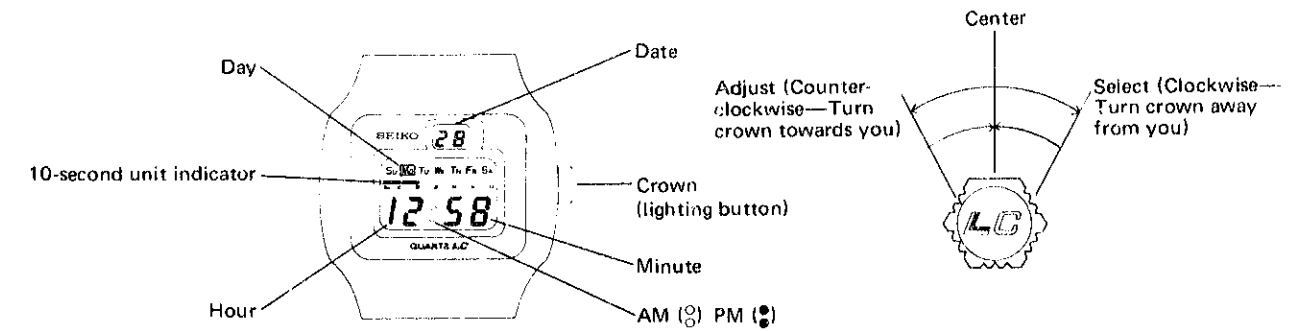

2. How to set the time, day and date

Example: How to change the indication of 11:58:50 AM of the 10th, Friday into 1:05:00 PM of the 13th, Monday.

1) Pull out the crown to the first click, and the digit adjustment is ready.



2) How to set the date

Turn the crown 60° clockwise (away from you) and the date and 10-second unit indicator are only displayed and all other digits are extinguished. Release the crown and it will return to the center position automatically. Then, turn the crown 60° counterclockwise (towards you) and the date digit will go on counting 11, 12, 13... at every second. When "13" has appeared, return the crown to the center position.

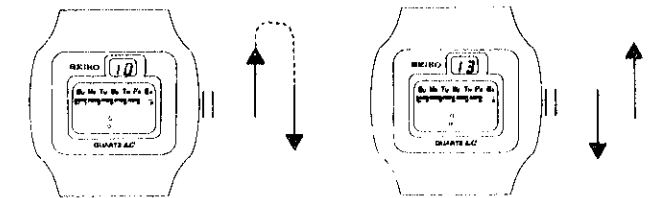

3) How to set the day

Turn the crown 60° clockwise, the day digit and 10-second unit indicator will appear. Just as with 2), turn the crown 60° counterclockwise to adjust the day digit.

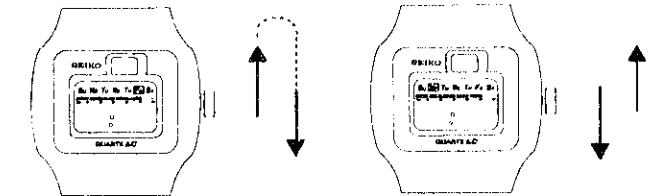

4) How to set the time

Turn the crown 60° clockwise, and the hour and 10-second unit indicator will appear. Just as with 2), turn the crown 60° counterclockwise to adjust the hour. While adjusting the time, be sure to check if it is A.M. (☉) or P.M. (☿).

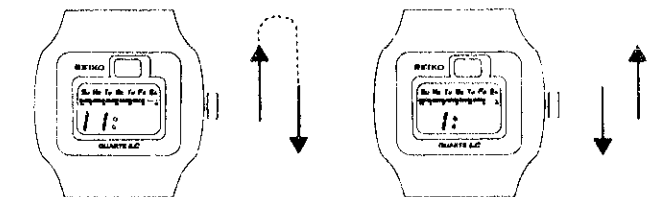

IV. DISASSEMBLING AND REASSEMBLING

5) How to set the minute and second

Turn the crown 60° clockwise and the minute and 10-second unit indicator will appear. Just as with 2), turn the crown 60° counterclockwise to adjust the minute. When the minute digit is adjusted, the second is automatically reset to "00" second (the 10-second unit indicator starts at "00" second.)

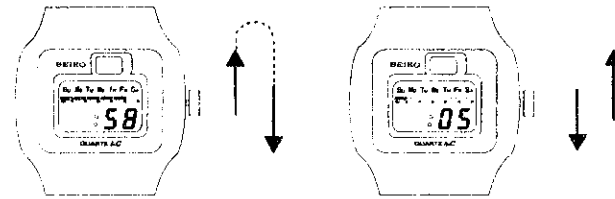

6) Now, all adjustment procedures have been finished. Push the crown in to the normal position and all digits will be displayed on the panel, and the watch will start precisely from 1:05:00 PM of the 13th, Monday.

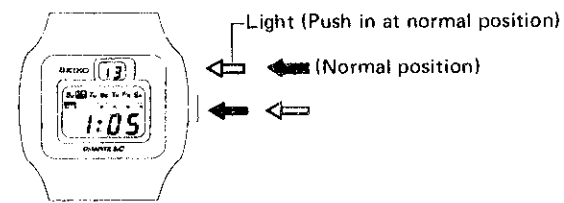

7) When travelling through different time zones

If for example only the hour is to be changed (i.e. travelling through time zones) then it is necessary to pull out the crown to the first click and follow these procedures:

1. Turn the crown 60° clockwise and release. (This accounts for the date function without changing the date.)

2. Turn the crown again 60° clockwise and release. (This accounts for the day function without changing the day.)

3. Turn the crown for the third time 60° clockwise and release. Then follow procedures as outlined in step 4) above.

For changing minutes and seconds follow the above instructions and then proceed to step 5).

Remarks:

1. Even when the date, day and hour digits are being adjusted, the minute and second are not affected and function correctly.

2. In case of the digit display is read in the dark, push the crown in at the normal position to light the illuminating light.

3. When only adjustment of the seconds is required. Pull out the crown all the way to the first click, and when all digits are displayed, push the crown in. Then the 10-second unit indicator will start from "00" second. (When the 10-second unit indicator is counting between "01" and "29", the second is reset to "00" second automatically but when the 10-second unit indicator is counting between "30" and "59", one minute is added and is reset to "00" second.)

1. After-servicing instruments and materials

For after-servicing of SEIKO Digital Quartz Cal. 0124A, the following after-servicing instruments and materials are necessary.

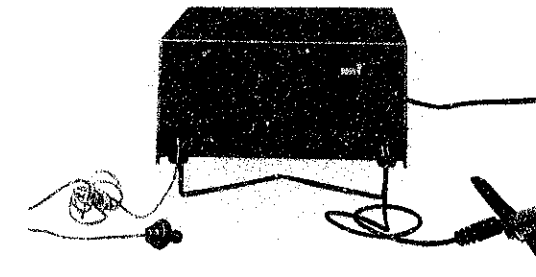

Quartz Tester, QT-10

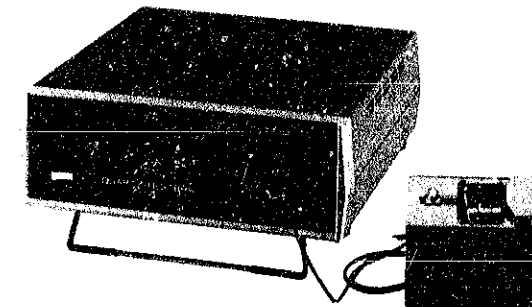

Tester

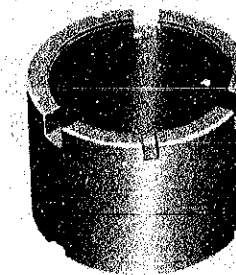

Movement Holder

2. Disassembling and reassembling of the case

Disassembling procedures Figs. ① ~ ⑫

Reassembling procedures Figs. ⑫ ~ ①

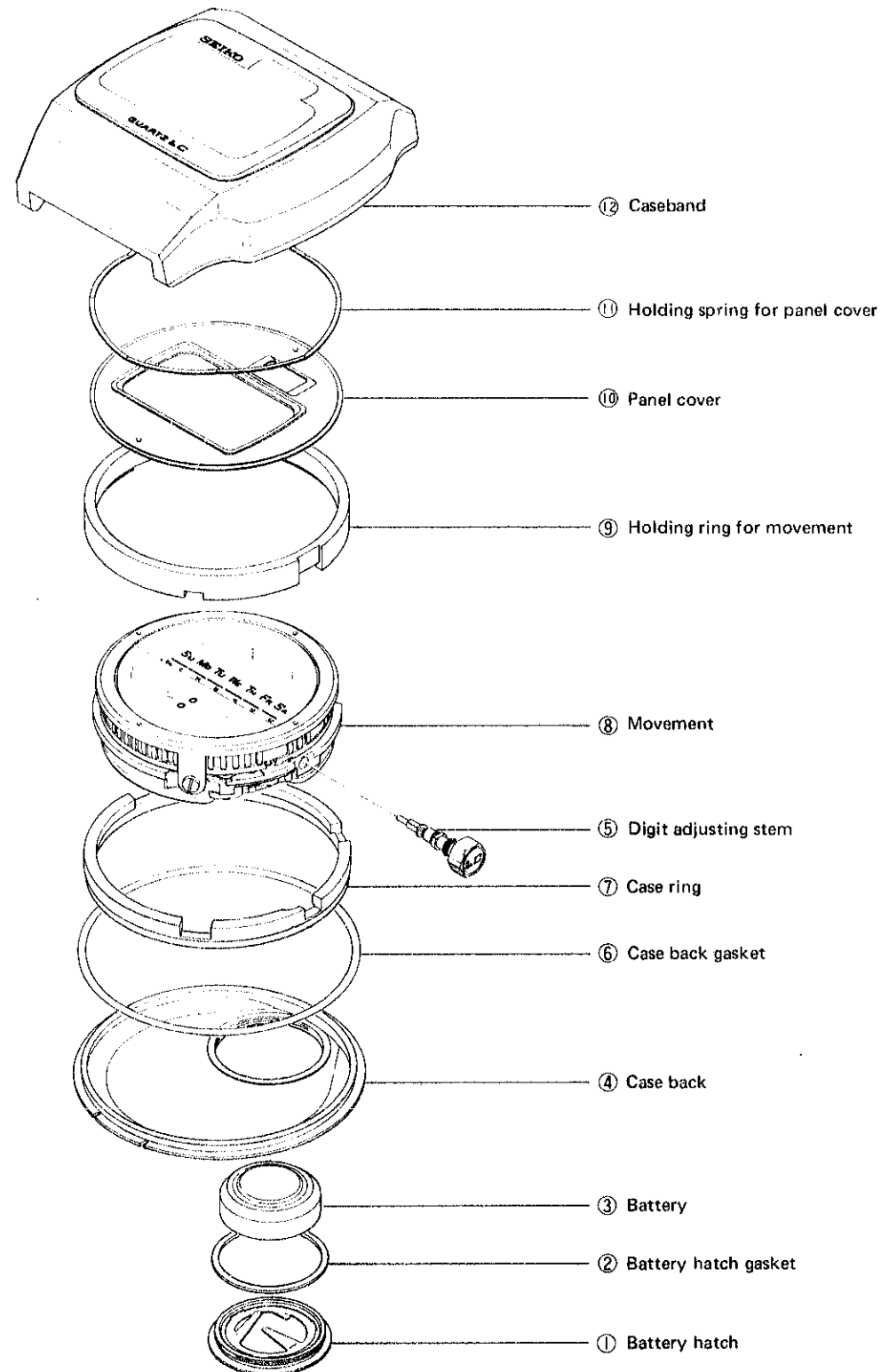

Remarks for disassembling and reassembling

Battery ③

Incomplete digital figures may show on the display panel after battery replacement. However, this is not a malfunction. Should this occur pull out the crown to the first click and push it back to lighting position. Next correct the digital display figures of each segment of the display panel as mentioned in the adjusting method of second, date, hour and minute on page 3.

How to close the case back ④

Wipe off the dirt and dust on the gasket with alcohol beforehand.

Apply the alignment notch on the case back to the opening notch on the caseband and push in the case back.

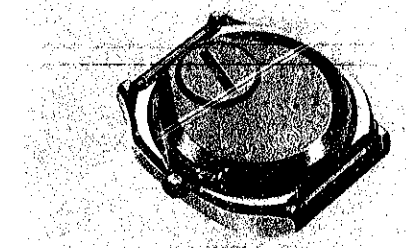

Follow these procedures:

- (1) Select a suitable inserting disk which fits either the case or bezel width.

Remarks:

- Place the watch on the inserting disk with the dial side down. For case inserting disks and bezel inserting disks, the placement is the same: face down.
- Use an inserting disk with a diameter of at least 32.0 mm.
- Place the inserting disk on the case back. Gently push the inserting disk with the fingers until the case back becomes even with the case. Move the case slightly until the case back is in the correct position and apply pressure with the tightening tool (S-220) to snap it closed. It cannot be snapped into place with the fingers. If an inserting disk with a smaller diameter is used, the case back cannot be snapped closed.

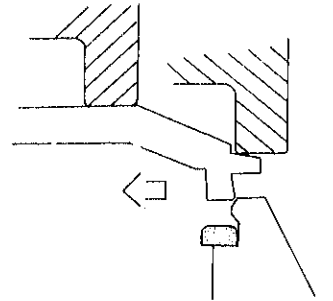

How to remove or replace the digit adjusting stem ⑤

- Pull out the digit adjusting stem at the center position (see the illustration on the right) after loosening the stem unlocking screw by turning four (4) or five (5) turns.

Remarks:

The stem setting spring is always on the flange of the stem unlocking screw. If this spring slips off the flange, the digit adjusting stem may not come out.

- After replacing the digit adjusting stem, make sure if the crown can be pulled out and pushed in correctly.

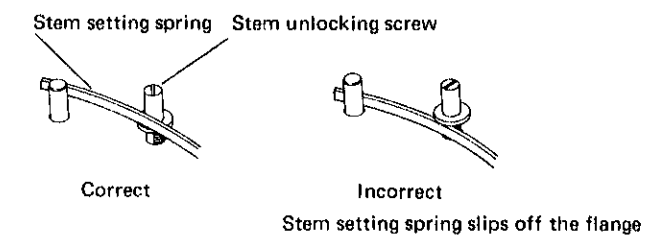
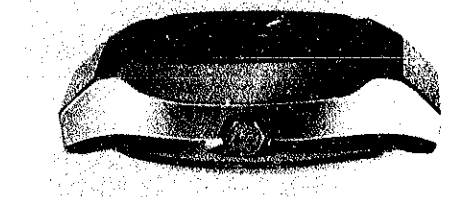

How to replace the panel cover ⑩

The panel cover has legs. Put the legs into respective holes on the panel frame of the movement.

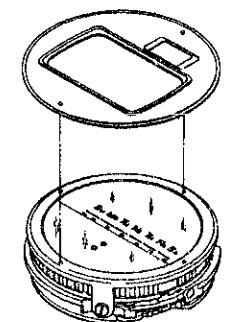

3. Disassembling, reassembling of the movement and lubricating of the switch components

Disassembling procedures Figs. ① ~ ⑳

Reassembling procedures Figs. ㉕ ~ ①

Lubricating:  SEIKO watch oil S-6.
Normal quantity

3.1 Liquid crystal panel and circuit block (A)

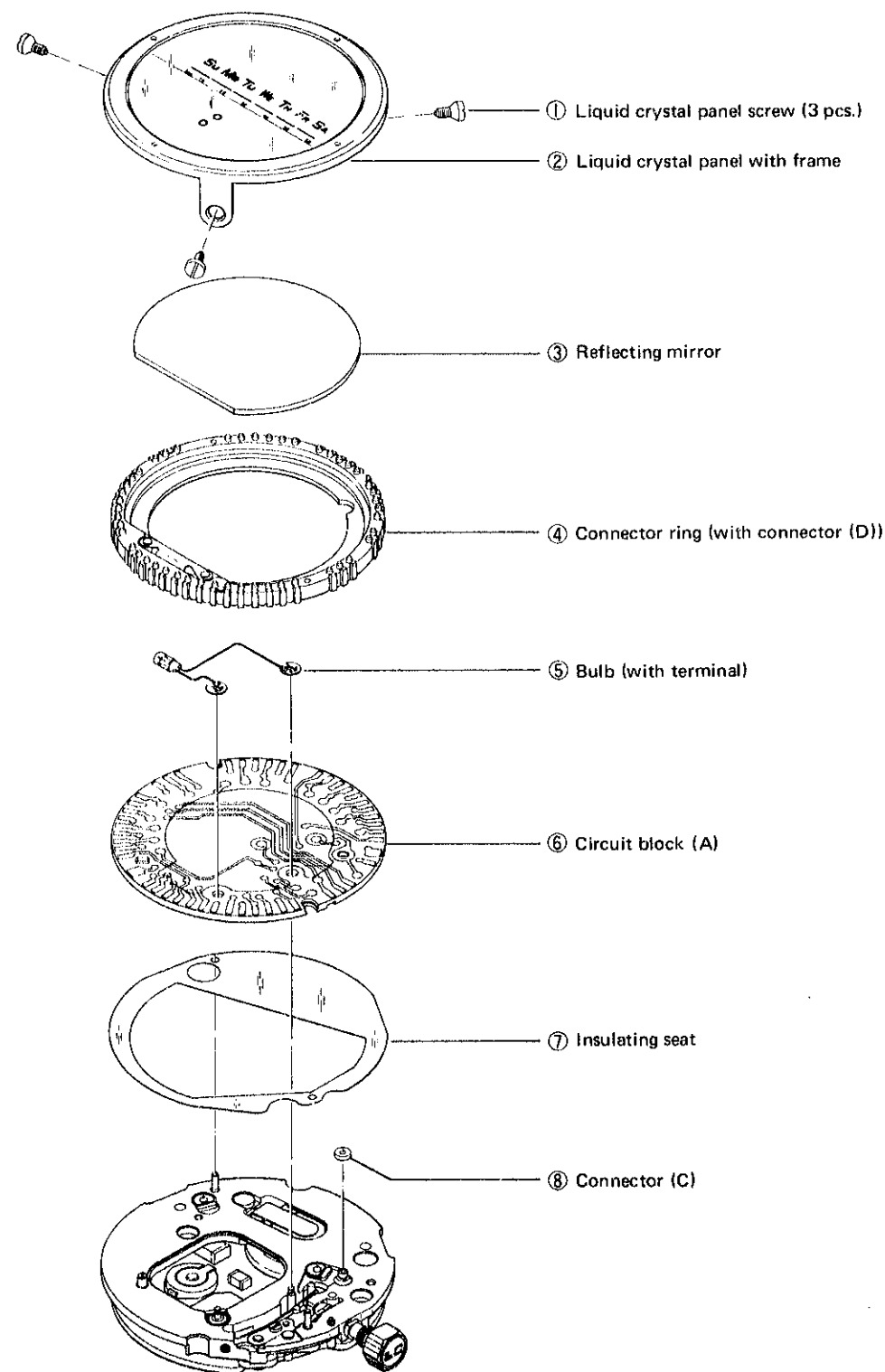

Remarks for disassembling and reassembling

Liquid crystal panel ②

When disassembling or reassembling the liquid crystal panel, be sure to hold the frame (metallic portion). Don't hold the front side of the liquid crystal panel directly. Otherwise, it will become iridescent.

The panel frame has been treated with insulating varnish. Be careful not to scratch the inside surfaces of the three legs on the panel frame or there will be a shortcircuit between the connector (D) and legs.

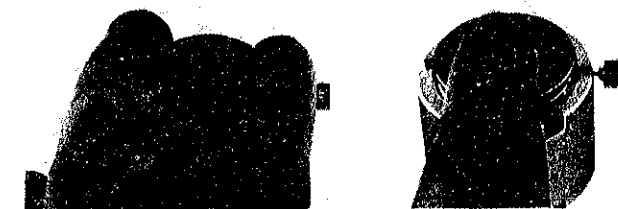

Correct

Incorrect

Reflecting mirror ③

There are obverse and reverse.

The obverse (to face the liquid crystal panel) . . . milk-white.

The reverse (to face the circuit block (A)) . . . black.

If it is replaced upside down, the display will become dim.

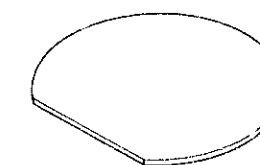

Connector ring ④

Do not remove or push aside the connector (D).

If the height of the connector (D) is different, it causes poor conductivity that leads to a poor display effect.

Bulb ⑤

- Removal and replacement of light bulb

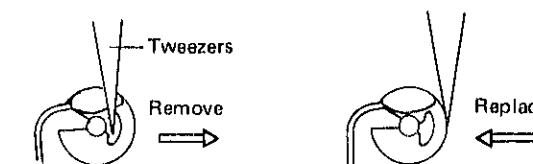

- Be careful not to touch the lead wires to each other.

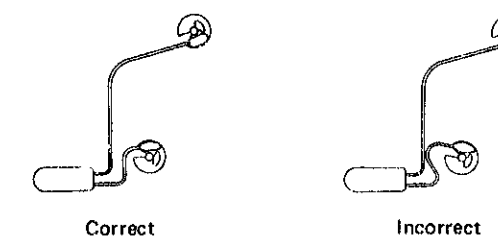

Correct

Incorrect

Circuit block (A) ⑥

There are two connectors (A) and (B) at four places each on the reverse of the circuit block (A). Be sure that if these connectors are in position before reassembling.

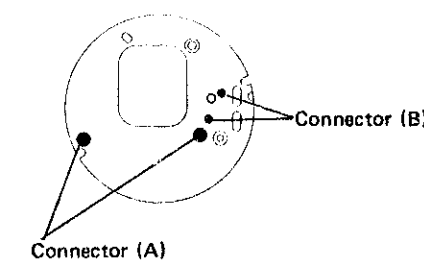

3.2 Screw for circuit block and setting mechanism

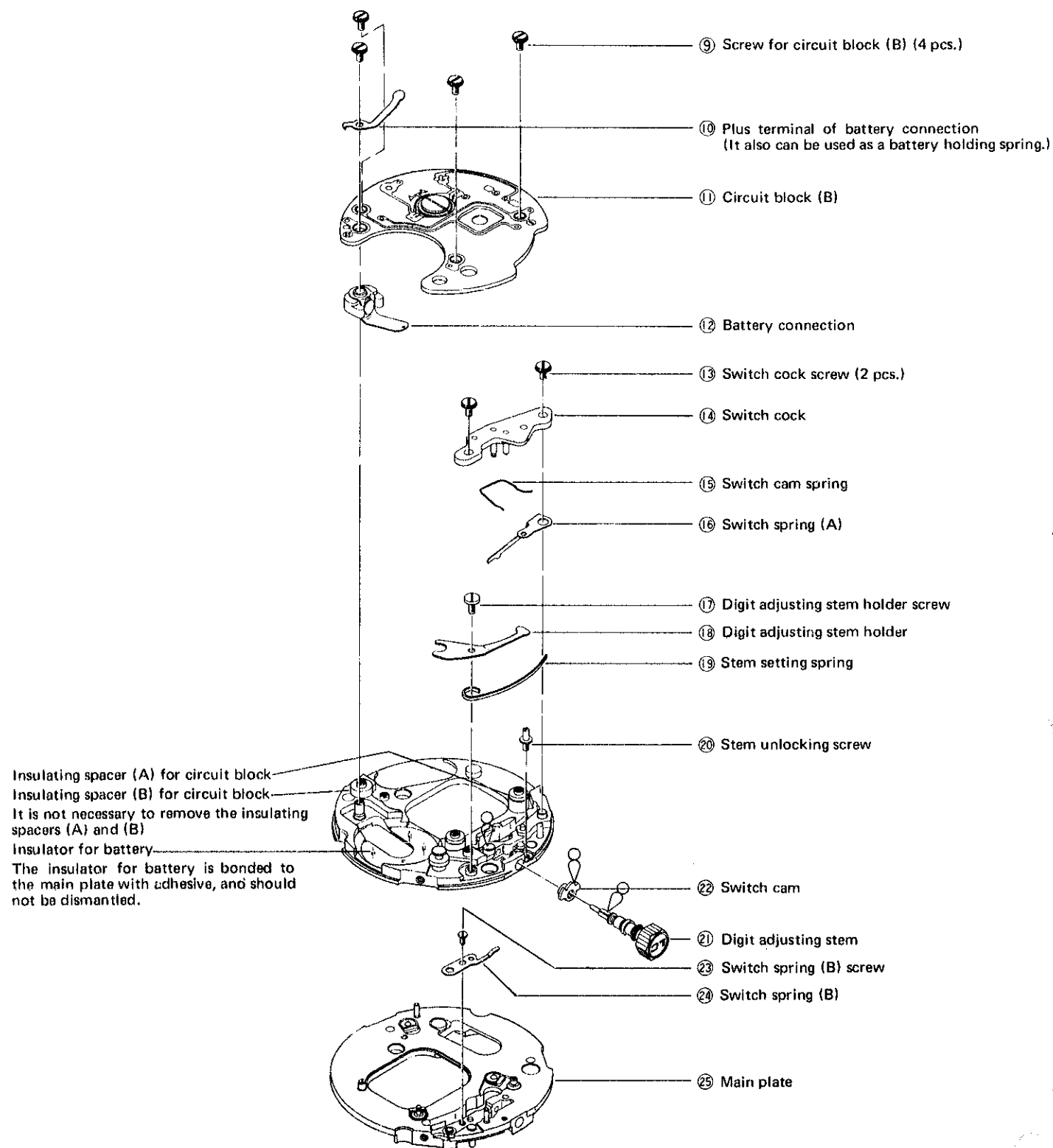

Reassembling procedures of the switch cam spring, switch spring (A) and stem setting spring

15 16 19

Reassemble the switch cam spring, switch spring (A) and stem setting spring as illustrated below.

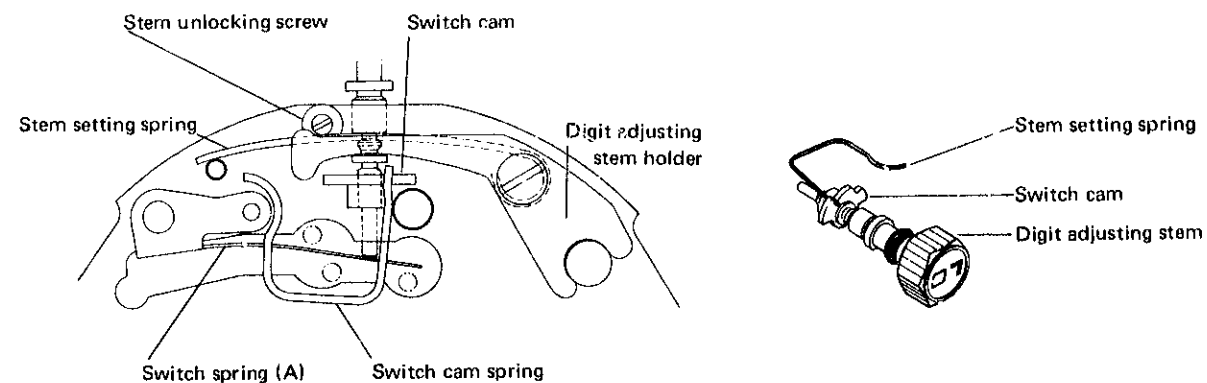

- Disassemble and reassemble the switch spring (A) when the digit adjusting stem is at the first click.

Check to see if the switch spring (A) contacts the switch pin correctly 14

The switch cock has three pins. Contact of these pins with the switch spring (A) permits the adjustment of display and the lighting of the bulb. Make sure that the switch spring contacts each pin correctly when the digit adjusting stem is at the normal position, first click and push.

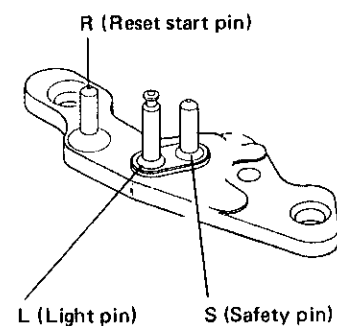

Crown position (seen from the panel side)

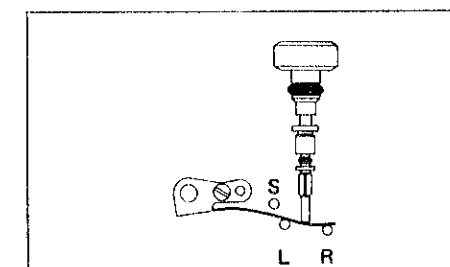
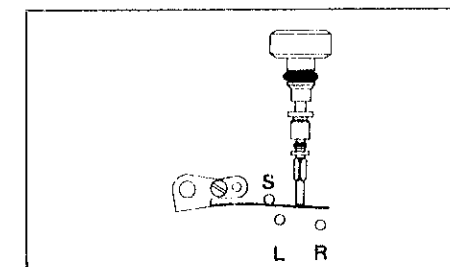
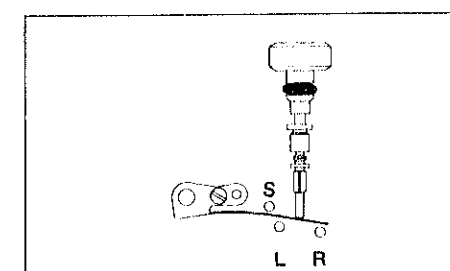





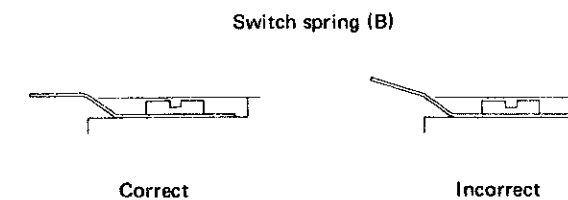

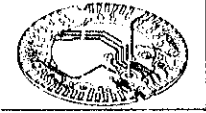

Switch spring (B) 24

Make sure that the tip of the switch spring (B) is flush with the main plate.



4. Cleaning

Name of parts	Cleaning	Drying	Solution	Remarks
(1) Circuit Block (A)  Circuit Block (B)  Bulb 	DO NOT CLEAN			Clean the conducting portion only with a cloth moistened with benzine or alcohol. Dry in <u>COOL</u> air.
(2) Liquid crystal panel  Reflecting mirror 	DO NOT CLEAN			<ul style="list-style-type: none"> Wipe dust and lint off with a soft, dry brush. Clean the conducting portion with a cloth moistened with alcohol. Dry in <u>COOL</u> air.
(3) Connector ring (with connector (D))  Connector (C) 	Wash gently with a soft, dry brush	Cool air	Alcohol	<ul style="list-style-type: none"> Be careful not to bend the connector. Be careful not to slip off the connector (D). Clean them as fast as possible.
(4) Main plate 	Wash with a soft, dry brush	Cool air	Benzine	<ul style="list-style-type: none"> Be careful not to peel off the insulator for battery connection. Check to see if there is any filings around the insulator pin.
(5) Plastic parts	Wash with a soft, dry brush	Cool air	Alcohol	
(6) Other parts	Clean with cleaner, wash with a soft, dry brush	Hot or cool air	Benzine, trichloroethylene	

V. CHECKING AND ADJUSTMENT

1. Guide for checking and adjustment

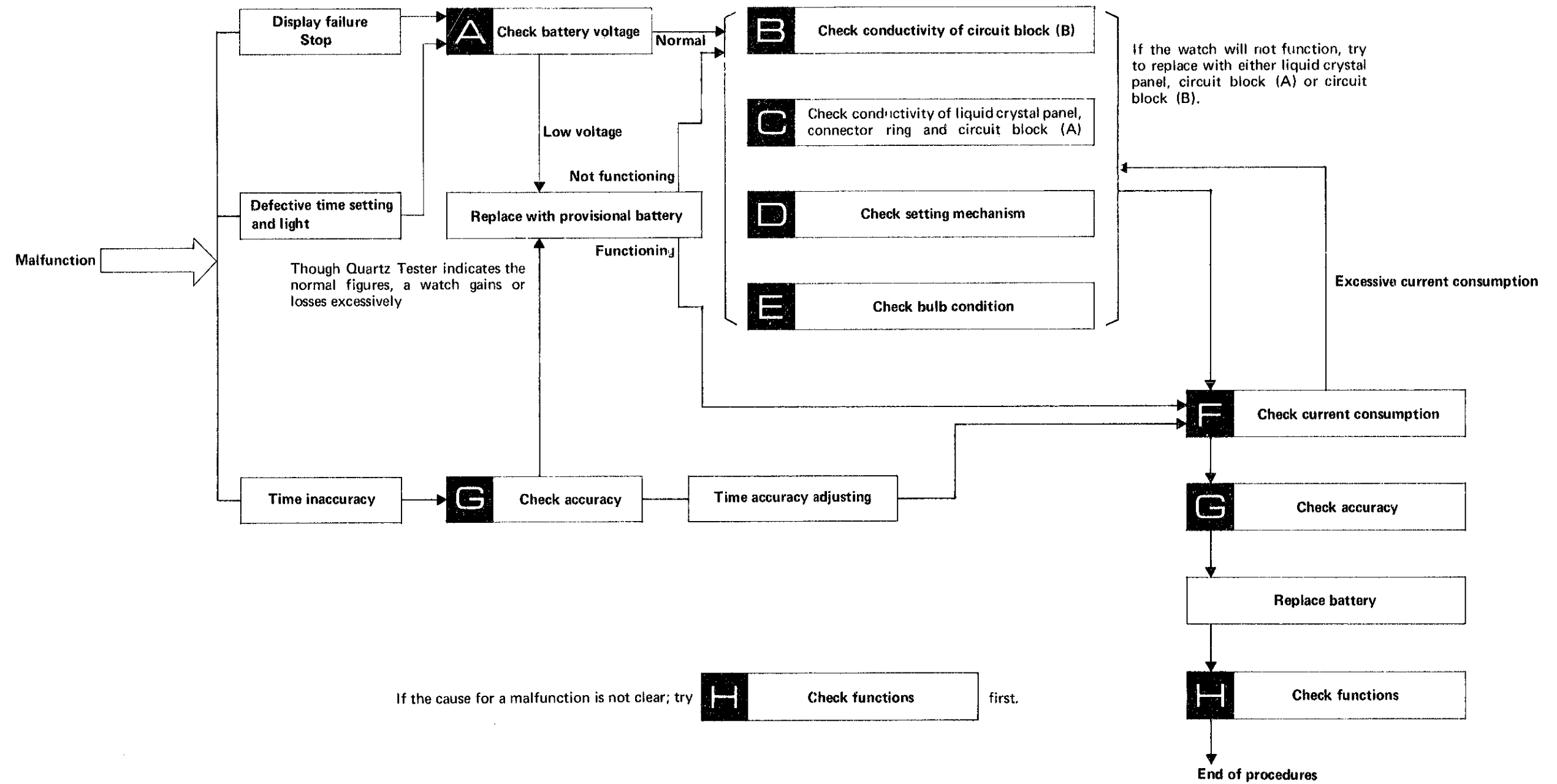

2. Malfunction and checking points

- Check in the numerical order.
- Refer to "Procedure for checking and adjustment" on page 15.

FAULTY SYMPTOMS		CHECKING PORTIONS							
		A	B	C			D	E	
		Battery	Loosened screw for circuit block (B)	Liquid crystal panel	Circuit block (A)	Circuit block (B)	Connector ring	Setting mechanism	Bulb
Display failure	Stop. (Though the digits are displayed but do not change or the 10-second unit indicator does not blink.)	①	②		⑤	④		③	
	No digital display, dim digital display or extremely poor response.	①	③	④	⑤	②			
	Some segments of the digital figure are not lighted or dim.			②	③		①		
	All digits blink every second.			①	②				
	All segments are displayed or the segment which should be displayed are not displayed while the segment which should not be displayed are displayed as shown in the illustration.			②	③		①		
	Some portions of the liquid crystal panel will make black dots or iridescent circles.			①					
Time inaccuracy	Gain or loss tested by Quartz Tester.	③	①			②			
	Though Quartz Tester indicates the normal figures, a watch gains or loses when it is worn on the wrist.	①	②		③				
Defective time setting or light	Light is not lit or light is lit but dims soon.	①						③	②
	Time adjusting is impossible or the digital display is extinguished while time adjusting is being made.	①			③			②	

3. Procedures for checking and adjustment

A Check battery voltage

- Use the following procedures to check battery voltage.

(1) **Set up the Tester**

Range to be used: DC 3V

(2) **Measuring**

- Probe Red (+) Battery surface (+)
- Probe Black (-) . . . Battery surface (-)

(3) **Result:**

More than a 1.5V reading indicates: Proceed to
Less than a 1.5V reading indicates: Replace with
a provisional battery.

B ~ **H**

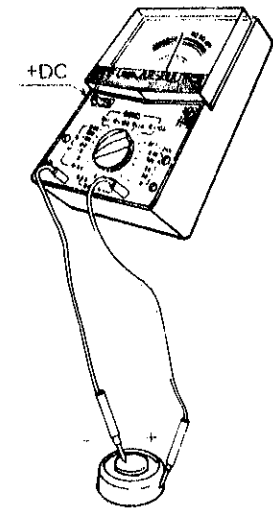

B Check circuit block (B) conductivity

(1) **First check**

Check whether the four screws for the circuit block (B) are loose.

Result:

No loosened screw: Proceed to

Loosened screw: Retighten screws.

B

(2) **Second check**

Check to see if there is any contamination on the battery, battery connection and plus terminal of battery connection.

Result:

Uncontaminated: Proceed to

Contaminated: Wipe off carefully.

C

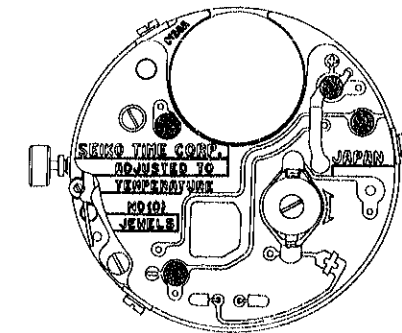

C Check conductivity of liquid crystal panel, connector ring and circuit block (A)

- Check to see if the conductivity of each connecting portion is normal.

(1) **First check**

Check if the connector (D) is properly placed in the connector ring according to the following procedures.

1. Uneven height of the connector (D).
Correct the setting of the connector (D).
2. Connector (D) is out of the ring.
Push it in to even height.
3. Defective connector (D) (crack, speck, etc.)
Replace with a new connector (D).
4. Contamination of connector (D).
Clean the connector (D) together with connector ring with alcohol.

(2) **Second check**

Check the liquid crystal panel electrode (connecting portion of the connector (D)) for stain and glass defects.

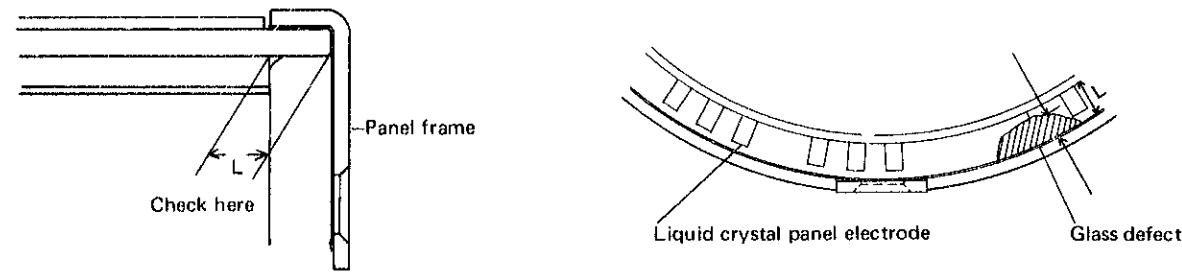

Liquid crystal panel

1. Contamination of liquid crystal panel electrode
Wipe off with a cloth moistened with alcohol.

2. Glass defect
Glass defect is less than a half of the electrode width (L): Proceed to **C**
Glass defect is more than a half of the electrode width (L):
Replace with a liquid crystal panel.



3.

(3) **Third check**

Make sure that there is no stain or filings on the electrode of the circuit block (A) (connecting portion of the connector (D)).

1. Contaminated: Wipe off with a cloth moistened with alcohol.
 2. Filings: Remove the filings.
- The mechanism of the segment of the liquid crystal panel and the electrode of the liquid crystal panel is shown in the illustration.

When some digits are extinguished or become dim, check the panel electrodes, connector (D) and circuit block (A) in the above three check procedures.

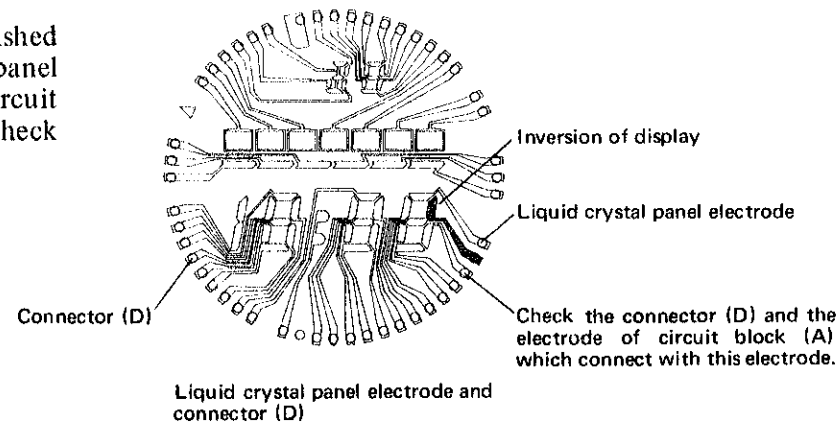

Remarks:

If the three legs on the panel frame are scratched, they will shortcircuit with the connector (D) and a part of the display may be extinguished. Apply paint on the scratched parts of the legs to insulate.

D Check setting mechanism

Check to see if the setting mechanism works correctly.

(1) **First check**

Check the connecting conditions of the switch spring (A) and three pins of the switch cock.

Crown positions:

Normal position: The switch spring (A) does not connect with any pin.

First click: It connects with the safety pin only.

Push: It connects with firstly the Reset start pin and secondly the Light pin.

Defective contact with the pin at each crown position . . . Replace with a new switch spring (A).

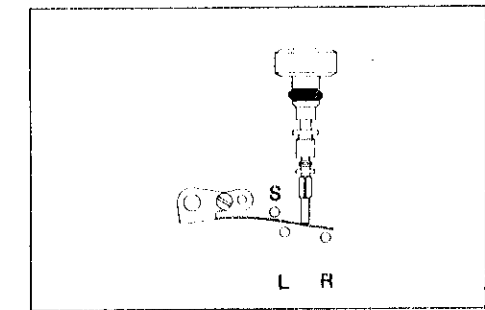

Normal position

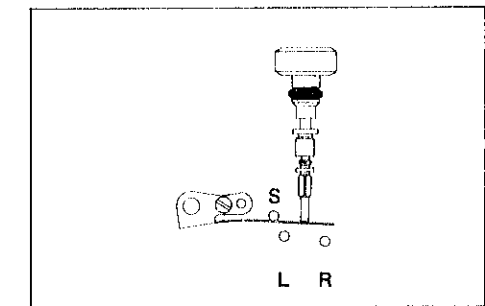

First click

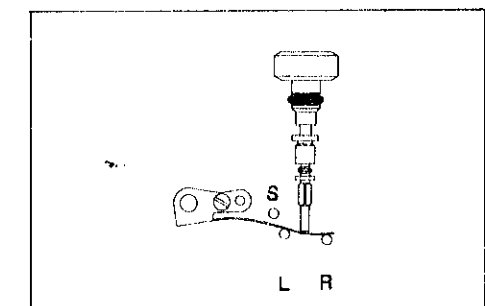

Push

- Check to see if there is any contamination or dust, lint and filings on the switch spring (A) and three pins (Safety, Light and Reset pins).

(2) **Second check**

Check the switch spring (B) for break, buckling and stain.

1. Break Replace with a new switch spring (B).
2. Buckling . . . Correct with a pair of tweezers as illustrated on the left.
3. Contaminated . . . Cleaning.



(3) **Third check**

Make sure that the four connectors on the reverse side of the circuit block (A) have not slipped off.

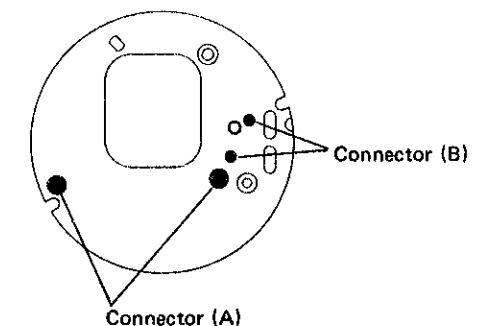

E Check bulb condition

Make sure that the bulb is not burnt-out.

- (1) **Set up the Tester**
Range to be used: OHMS R × 1
- (2) **Measuring**
Apply the probes (Either red or black probe will do.) to the two terminals of the bulb.
- (3) **Result**
Light up: Proceed to **F**
Not light up: Replace with a new bulb.

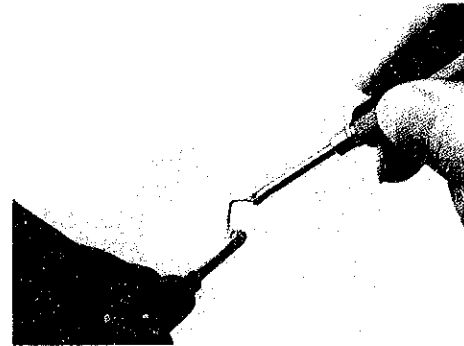

F Check current consumption

Check to see if the current consumption is normal.

- (1) **Set up the Tester**
Range to be used: D.C. 0.03 mA
- (2) **Measuring**
Probe Red (+) Battery connection
Probe Black (-) . . . Battery surface (-)
- (3) **Result:**
Less than 10 μA: Proceed to **G**

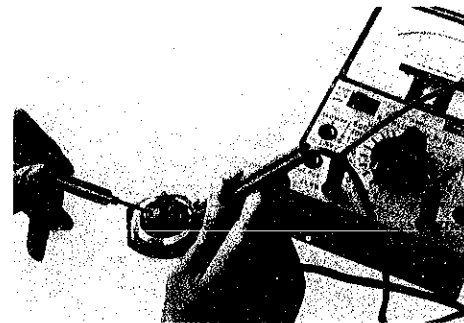

More than 10 μA: Proceed to **B** **C** **D** for re-checking.

G Check accuracy

Check gain and loss of time.

- (1) **Set up the Quartz Tester and insert the plug of the power supply cord into the plug socket.**

The electric-field detection microphone for QT-10.

The oscillation detection microphone for QT-100.

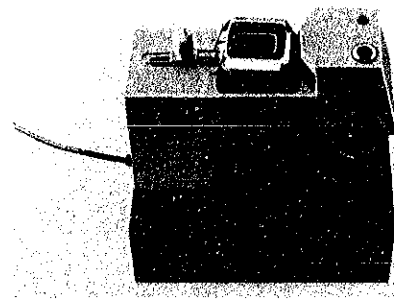
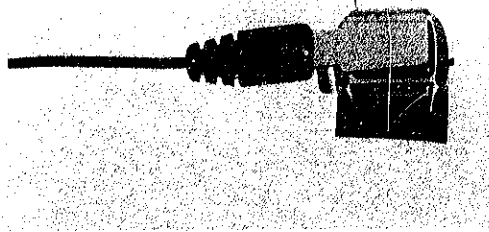

• **Time accuracy adjusting**

Time accuracy is adjusted by turning the trimmer condenser.

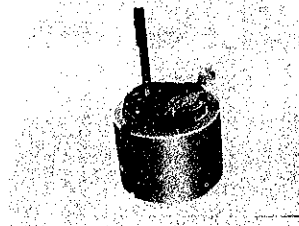

Remarks:

When measuring the time accuracy of the movement with the electric field detection microphone of QT-10, follow the procedures below.

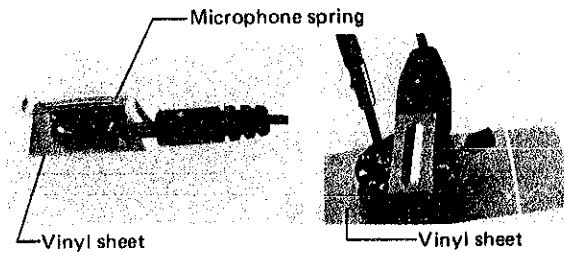

- 1) Place a vinyl sheet between the liquid crystal panel face and the microphone.
- 2) Place the movement so that the microphone spring touches the battery.
If the microphone spring touches the circuit block (B), the gain/loss measurement may not be possible.

- 3) Measurement is made while the level adjuster is in the AUTO position. But, in case the input indicator has ceased to be lit or blinked irregularly while measuring, this is due to the faint signal levels caused by the variations in digital indications of the watch. In such a case, turn the level adjuster.

- Adjustment should be made after ascertaining the daily rate with Quartz Tester whether the watch tends to gain or lose. The watch gains or loses according to the direction in which the trimmer condenser is turned.
- Note for turning of Trimmer Condenser
 - (1) Avoid excessive depressing.
 - (2) Avoid turning the Trimmer Condenser excessively.
- Capacity of Trimmer Condenser
The capacity is changed by turning the Trimmer Condenser as shown in the diagram below.

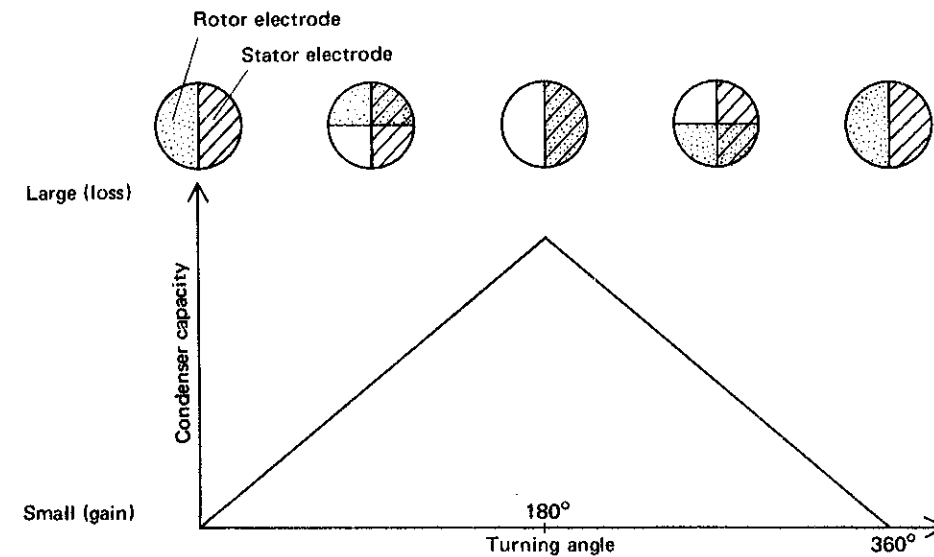

H Check functioning

Check to see if each time setting function works correctly.

Note:

Incomplete digital figures may show on the display panel after battery replacement. However, this is not a malfunction. Should this occur pull out the crown to the first click and push it back to lighting position. Next correct the digital display figures of each segment of the display panel as mentioned previously in the adjusting method of second, date, hour and minute.

Use the following procedures to check the functioning.

(1) First check

Check to see if the digit will change every second correctly and there is any segment which is not indicate according to the following method.

1. Date setting: More than 1 cycle (worth 31 days)
2. Day setting: More than 1 cycle (worth 7 days)
3. Hour setting: More than 1 cycle (worth 24 hours)
4. Minute setting: More than 1 cycle (worth 60 minutes)

(2) Second check

Check the functioning of the 10-second unit indicator.

1. Adjust the display and set the watch at 11:59 PM of the 31st, Saturday.
2. Start the watch, and make sure that the 10-second unit indicator blinks and moves correctly.
3. Make sure that the display will indicate, one minute later, 12:00 AM of the 1st, Sunday.



(3) Third check

Pull out the digit adjusting stem to the first click and push it back in order to check if the second display is returned to "00" second.

(4) Fourth check

Push in the crown at the normal position, and make sure that the light is lit up.

4. Packing and maintenance of the spare parts

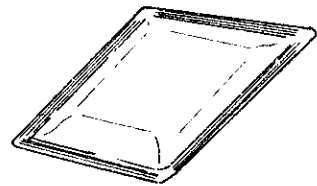
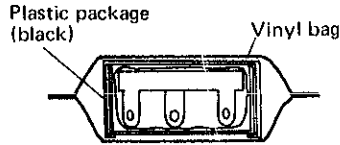
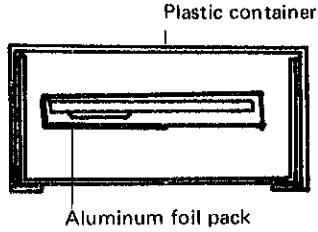
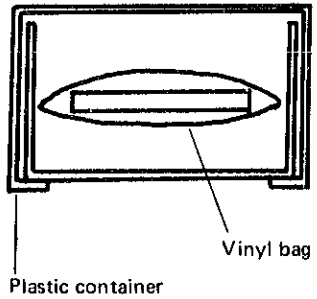
Name of parts	Packing method	Remarks
Liquid crystal panel	Aluminum pack (air-tight packing)  The package protects the liquid crystal panel from sunlight and humidity. 	<ul style="list-style-type: none"> Keep the liquid crystal panel in the following place to maintain the high quality. <ol style="list-style-type: none"> (1) Dark place (2) Low humidity (3) Low temperature
Circuit block (A) Circuit block (B)		<ul style="list-style-type: none"> MOS-IC is protected with an aluminum foil from static electricity.
Reflecting mirror, connector ring, bulb		<ul style="list-style-type: none"> Be careful not to break or scratch the reflecting mirror. Be careful not to bend the lead wire and lead terminal as they are connected to the bulb.
Others	Vinyl bag	