

TECHNICAL GUIDE

AND PARTS LIST

CAL. Y739A

DIGITAL QUARTZ

CONTENTS

| | |
|---|----|
| I. SPECIFICATIONS..... | 1 |
| II. CIRCUIT BLOCK SCHEMATIC..... | 1 |
| III. HOW TO USE..... | 2 |
| 1. Display and key operation..... | 2 |
| 2. Identification of keys..... | 3 |
| 3. How to set the time..... | 4 |
| 4. How to calculate..... | 6 |
| IV. DISASSEMBLING, REASSEMBLING, LUBRICATION AND CLEANING..... | 7 |
| 1. Disassembling, reassembling and lubrication of the case..... | 7 |
| 2. Disassembling, reassembling and lubrication of the module..... | 11 |
| 3. Cleaning..... | 12 |
| V. CHECKING AND ADJUSTMENT..... | 13 |
| 1. Guide table for checking and adjustment..... | 13 |
| 2. Relationship between the segments (Liquid Crystal Panel Electrode) and C-MOS-LSI output terminal..... | 14 |
| 3. Procedures for checking and adjustment..... | 15 |
| A. Check battery voltage..... | 15 |
| • How to check battery electrolyte leakage and repair..... | 15 |
| B. Check battery conductivity..... | 16 |
| C. Check current consumption..... | 16 |
| D. Check water resistance..... | 16 |
| E. Check contact of C-MOS-LSI ~ Liquid crystal panel..... | 17 |
| F. Check liquid crystal panel and circuit block..... | 17 |
| G. Check accuracy..... | 19 |
| • Adjust time accuracy..... | 19 |
| H. Perform sound demonstration..... | 19 |
| I. Check conductivity of the keyboard..... | 20 |
| J. Check speaker block..... | 20 |
| K. Check bulb condition..... | 21 |
| VI. PARTS LIST OF MODULE..... | 21 |

I. SPECIFICATIONS

| Item | Cal No. | Y739A |
|-------------------------------|---------|---|
| Display medium | | Nematic Liquid Crystal, FEM (Field Effect Mode) |
| Display system | | Time display Alarm display Calculator display |
| Calculator functions | | Addition, subtraction, multiplication, division, successive multiplication and division, mixed calculation, constant calculation, raising numbers to a power, reciprocals, percentage, additional and discount percentage, and calculation using the memory register. |
| Additional mechanism | | Auto-return feature, Pattern segment checking system Illuminating light |
| Crystal oscillator | | 32,768 Hz (Hz = Hertz Cycles per second) |
| Loss/gain | | Loss/gain at normal temperature Mean monthly rate: Less than 20 seconds (Annual rate: Less than 4 minutes) |
| Casing diameter | | φ31.0 mm |
| Height | | 6.2 mm without battery |
| Operational temperature range | | Watch function: -10~60°C (14~140°F), Display function: 0~50°C (32~122°F), Alarm function: 0~60°C (32~140°F) |
| Liquid crystal drive system | | 1/3 multiplex drive system |
| Regulation system | | Trimmer condenser |
| Quartz tester measuring gate | | Any measuring gate |
| Battery | | Silver oxide battery: UCC389, Maxell SR1130W, Toshiba WG10 or SR1130W Battery life: 1.5 years Voltage: 1.55V |
| IC (Integrated Circuit) | | C-MOS-LSI 1 unit |

II. CIRCUIT BLOCK SCHEMATIC

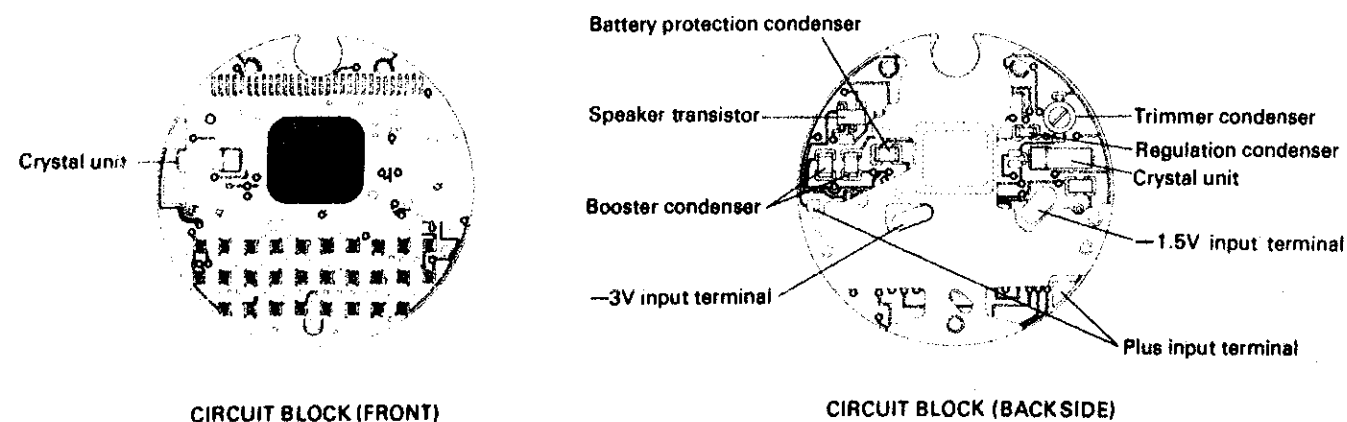

III. HOW TO USE

1. DISPLAY AND KEY OPERATION

At the push of a key (T, AC, AL or = key), the time display, calculator display or alarm display is activated.

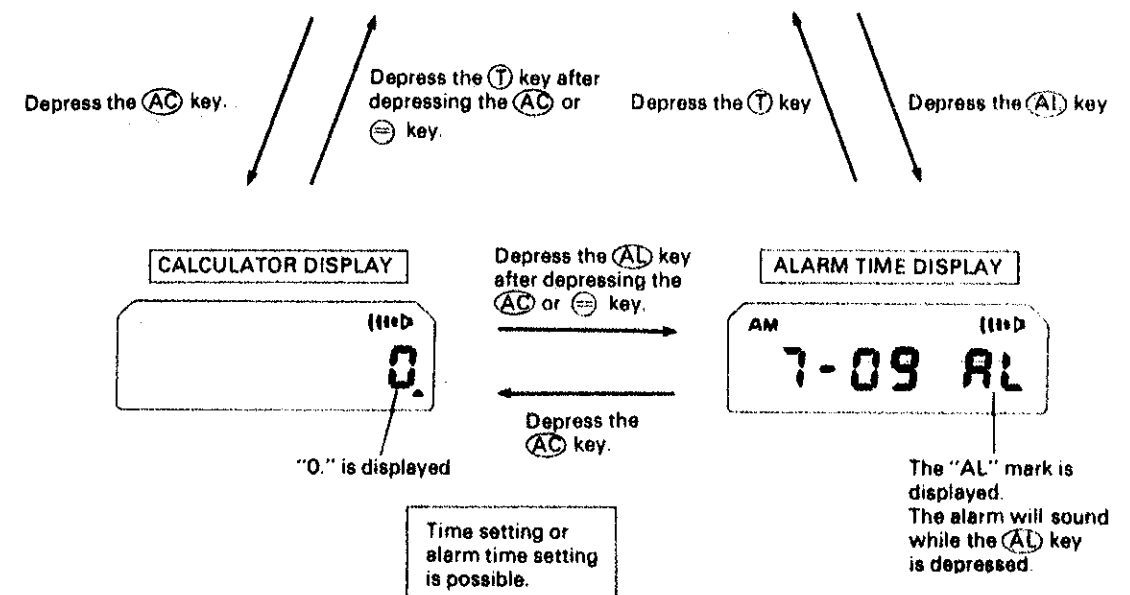
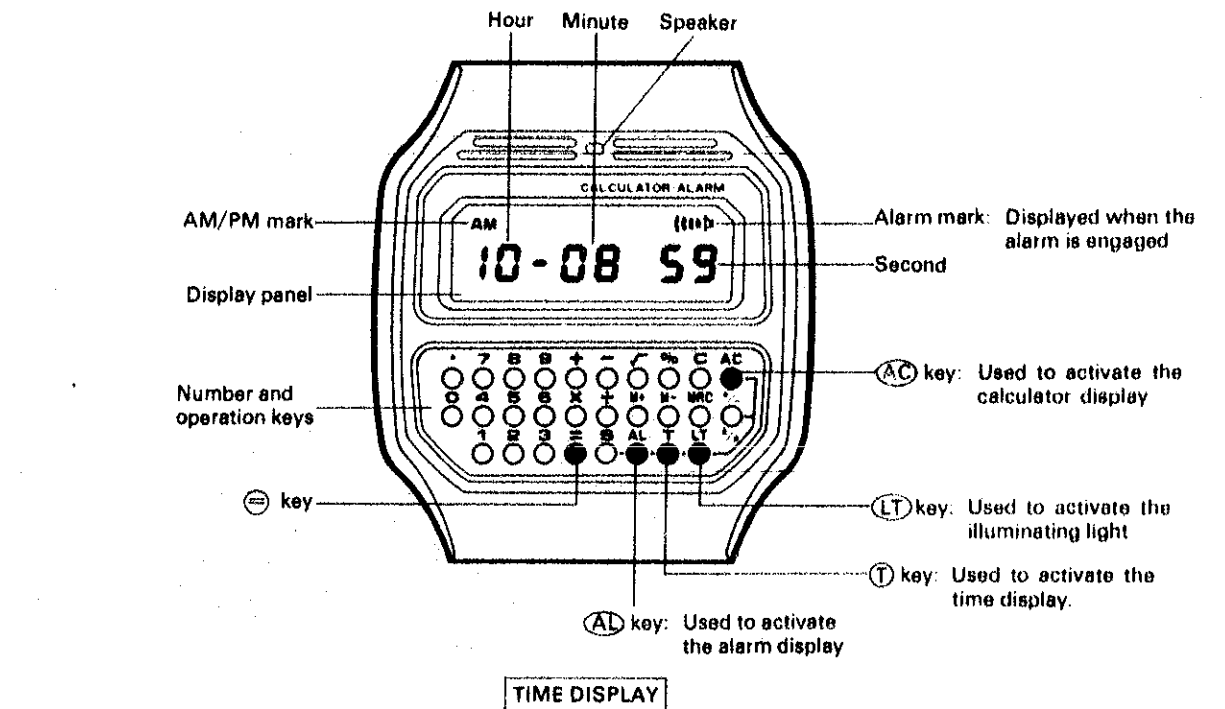

2. IDENTIFICATION OF KEYS

| Key | Name | Remarks |
|----------------|---|--|
| 0 ~ 9 . | Number keys Decimal point key | The number keys and decimal point key are used for registering numerical data. An eight-digit number can be registered. |
| + , - × , ÷ | Addition, subtraction, multiplication and division keys | The calculation is performed by pushing the desired operation's key. When an operation key is pushed by mistake, push the correct key next and the correct operation will be performed. Example: When the ⊖ key is pushed instead of the ⊕ key, push the ⊕ key again. |
| = | Equal key | Push and the answer is displayed. |
| % | Percentage key | Used to perform percentage calculations. |
| √ | Square root key | Used to perform square root calculations. When the digits are negative numbers, the square root of the absolute value is displayed. |
| M + M - | Memory plus key Memory minus key | Push the (M+) key and the displayed numbers will be added to the memory register. Push the (M-) key and the displayed numbers will be subtracted from the memory register. Push the (M+) key instead of the ⊖ key when you wish to add the answer to the memory register. Push the (M-) key instead of the ⊖ key when you wish to subtract the answer from the memory register. Example: 4 × 7 (M+) 4 × 7 ⊖ 28 The digits 28 are added to the memory register. Note: If the integral number of the digits to be added to or subtracted from the memory register is more than 8 digits, the error mark (E) is displayed, and the memory register will not be changed. |
| MRC | Memory recall key Memory clear key | Push it to display the contents stored in the memory register and push it again to clear the memory register. |
| + / - | Changeover sign key | Used to change the sign of the displayed numbers. (+ ↔ -). In the time setting and alarm time setting functions, "A.M." is changed to and from "P.M." |
| C | Clear key | When the (C) key is pushed after the ⊕, ⊖, ×, ÷, or = key is pushed, the answer is stored in the memory register and the display is cleared. When the (C) key is pushed after the number keys, + / - or the (MRC) key is pushed, all but the contents of the memory register are cleared. If the result of a calculation is accompanied by an error sign, push the (C) key, and the error sign will be removed. |
| AC | All clear key | • In the calculator function, all but the contents in the memory register are cleared by pushing the (AC) key. • In the time display or the alarm time display, the calculator function is activated by pushing the (AC) key. |
| T | Time key | • In the time display the "—" mark is displayed to indicate the second is ready to be adjusted by pushing the (T) key. • In the calculator function, the time setting function and the alarm time setting function are activated by pushing the (T) key. When it is pushed after the (AC) key is pushed, the time display is shown. • In the alarm time display the time display is shown by pushing the (T) key. |
| AL | Alarm key | • In the time display the alarm set time is displayed by pushing the (AL) key. • In the calculator function, the alarm set time is displayed by pushing the (AL) key. (Push the (AL) key after the (AC) or ⊖ key is pushed.) • In the alarm time display the alarm is tested by pushing the (AL) key continuously. |

| Key | Name | Remarks |
|-----|-----------|---|
| S | Set key | • In the time display when the (S) key is pushed after the (T) key is pushed, the seconds are reset to "00". • In the calculator function (in setting the time), push the (S) key after all adjustments are completed and the seconds are reset to "00" and start immediately. • In the alarm time display the alarm is engaged or disengaged by pushing the (S) key. |
| LT | Light key | The illuminating light is activated by pushing the (LT) key in each display |

3. HOW TO SET THE TIME

The time setting is made in the calculator display.
(Depress the (AC) key to reset the digits to "0".)

Ex.: Set the time to "PM 9:45".

| Key operation | Display |
|---------------|-------------|
| (AC) | 0. |
| (9) | 9. |
| (T) | 9- |
| (4) | 9- 4 |
| (5) | 9- 45 |
| (+/-) | PM 9- 45 |
| (S) | PM 9- 45 00 |

The "AM" mark also is displayed.

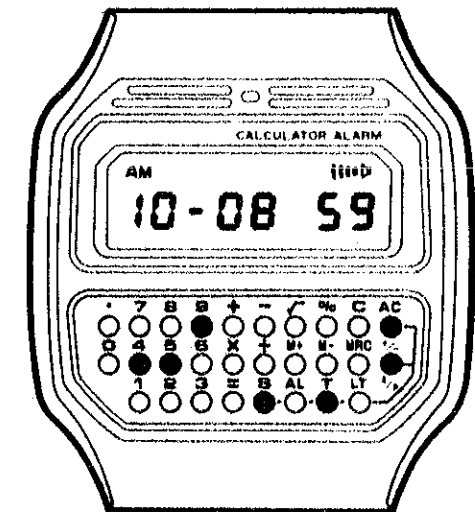

The "AM" and "PM" marks can be interchanged by depressing the (+/-) key.

Starts operating from "00" second.

How to adjust the time differential

When you are in a different time zone, use the following procedures for adjusting the time differential.

EX.: How to change 10:08:59 A.M. to 3:08:59 P.M.

| Key operation | Display |
|---------------|-------------|
| | AM 10-08 59 |
| (AC) | 0. |

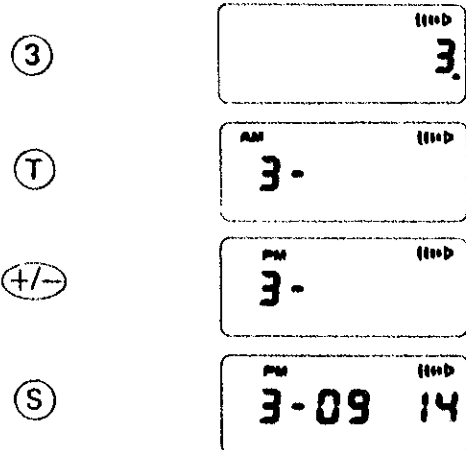

The "AM" and "PM" marks can be interchanged by depressing the +/- key.

Starts operating.
 ● While adjusting the hour digit, the minute and the second digits continue to advance.

How to set the alarm time

EX.: Setting the alarm to "PM 6:45".

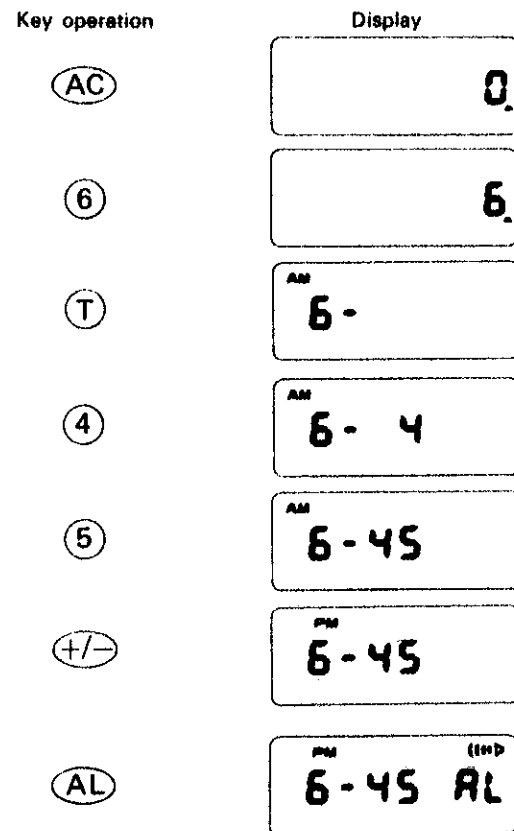

The "AM" mark also is displayed.

The "AM" and "PM" marks can be interchanged by depressing +/- key.

Depress the AL key to set the alarm. The "AL" mark and the alarm time are displayed.

- NOTE:**
- After setting the alarm, depress the T key to obtain the time display.
 - When a number greater than 12 for hours and 60 for minutes is entered in the time or alarm setting, an error sign "E" will be displayed when the T key or S key is depressed.
 - To correct the error, depress the AC key.
 - In any display, when the alarm time is reached, the alarm sounds for 1 minute.

Ex.: Setting the seconds to a time signal

- When the T key is depressed in the time display, the "-" mark is displayed for 1 ~ 2 minutes.
- When the "-" mark is displayed, depress the S key at the same time as the time signal. When the seconds show any number from 0 ~ 29, they are reset to "00". When the seconds show any number from 30 ~ 59, one minute is advanced and the seconds are reset to "00".

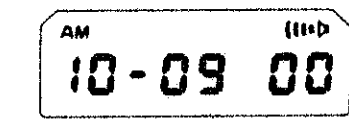
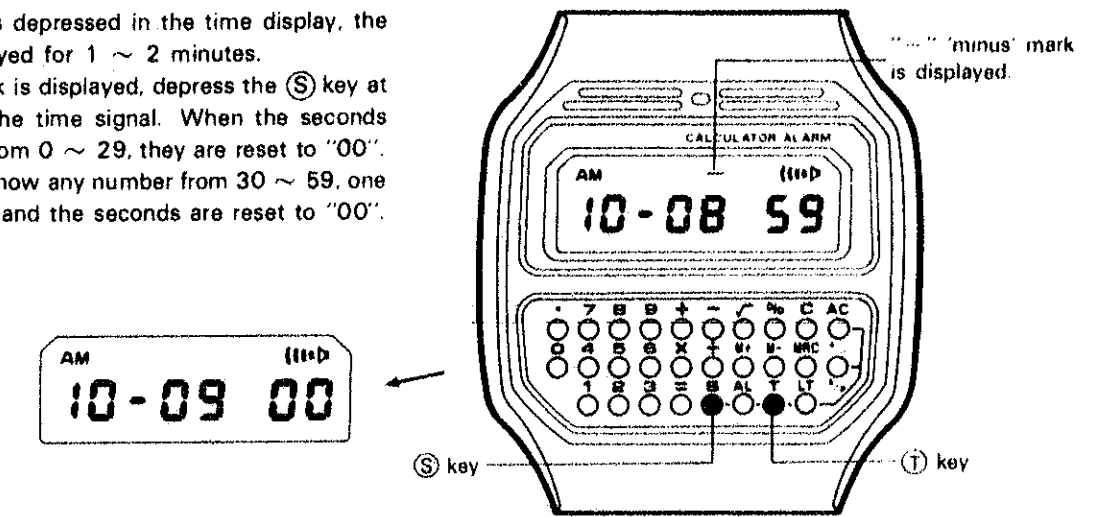

NOTE:

- When the "-" mark is displayed, depressing the AL key will not display the alarm time, but when the alarm is activated, it stops the alarm.
- When the AC key is depressed, the "-" mark is eliminated and the watch enters the calculator function.

4. HOW TO CALCULATE

| Calculation | Example | Key operation | Display |
|---|------------------------------------|------------------------------|-----------|
| Addition, subtraction multiplication and division | ● 246 - 64.2 + 357 = 538.8 | AC 246 - 64.2 + 357 = | 538.8 |
| | ● 975 × 4 ÷ 9 = 433.33333 | AC 975 × 4 ÷ 9 = | 433.33333 |
| | ● (5 × 3 + 7) ÷ 6 - 11 = -7.333334 | AC 5 × 3 + 7 ÷ 6 - 11 = | 7.333334 |
| Constant calculation (Multiplications with a constant multiplicand) | ● 975 × 7 = 6825 | AC 975 × 7 = | 6825 |
| | ● 975 × 6 = 5850 | 6 = | 5850 |
| Division by a constant divisor | ● 86 ÷ 5 = 17.2 | AC 86 ÷ 5 = | 17.2 |
| | ● 68 ÷ 5 = 13.6 | 68 = | 13.6 |
| | ● 11 + 24 = 35 | AC 11 + 24 = | 35 |
| | ● 17 + 24 = 41 | 17 = | 41 |
| (Addition with a constant addend) | ● 34 - 5 = 29 | AC 34 - 5 = | 34 |
| | ● 16 - 5 = 11 | 16 = | 16 |
| (Subtraction with a constant subtrahend) | | | |
| Raising numbers to a power | ● 4 ³ = 64 | AC 4 × = = | 64 |
| Inverse operation | ● 1/7 ² = 0.0204081 | AC 7 ÷ = = | 0.0204081 |
| Percentage | ● 1300 × 35% = 455 | AC 1300 × 35 % | 455 |
| | ● 119 ÷ 250 = 47.6% | AC 119 ÷ 250 % | 47.6 |
| Additional and discount percentage | ● 12% additional of 6500 | AC 6500 × 12 % + | 7280 |
| | ● 12% discount of 6500 | AC 6500 × 12 % - | 5720 |
| Extraction of square root | ● √25 = 5 | AC 25 √ | 5 |
| Mixed calculation | ● (25 - 11) / (5 - 3) = 7 | AC 5 - 3 M+ 25 - 11 ÷ MR/C = | M 7 |
| Overflow calculation | 1234567 × 25896 = 31970347032 | AC 1234567 × 25896 = | 31970347E |

IV. DISASSEMBLING, REASSEMBLING, LUBRICATION AND CLEANING

1. DISASSEMBLING, REASSEMBLING AND LUBRICATION OF THE CASE

Lubrication: Silicon grease (500,000 c.s.)
Normal quantity 

Glass and keyboard portions

It is not necessary to disassemble the glass and keyboard except when parts are replaced. (For details, refer to pages 9 and 10.)

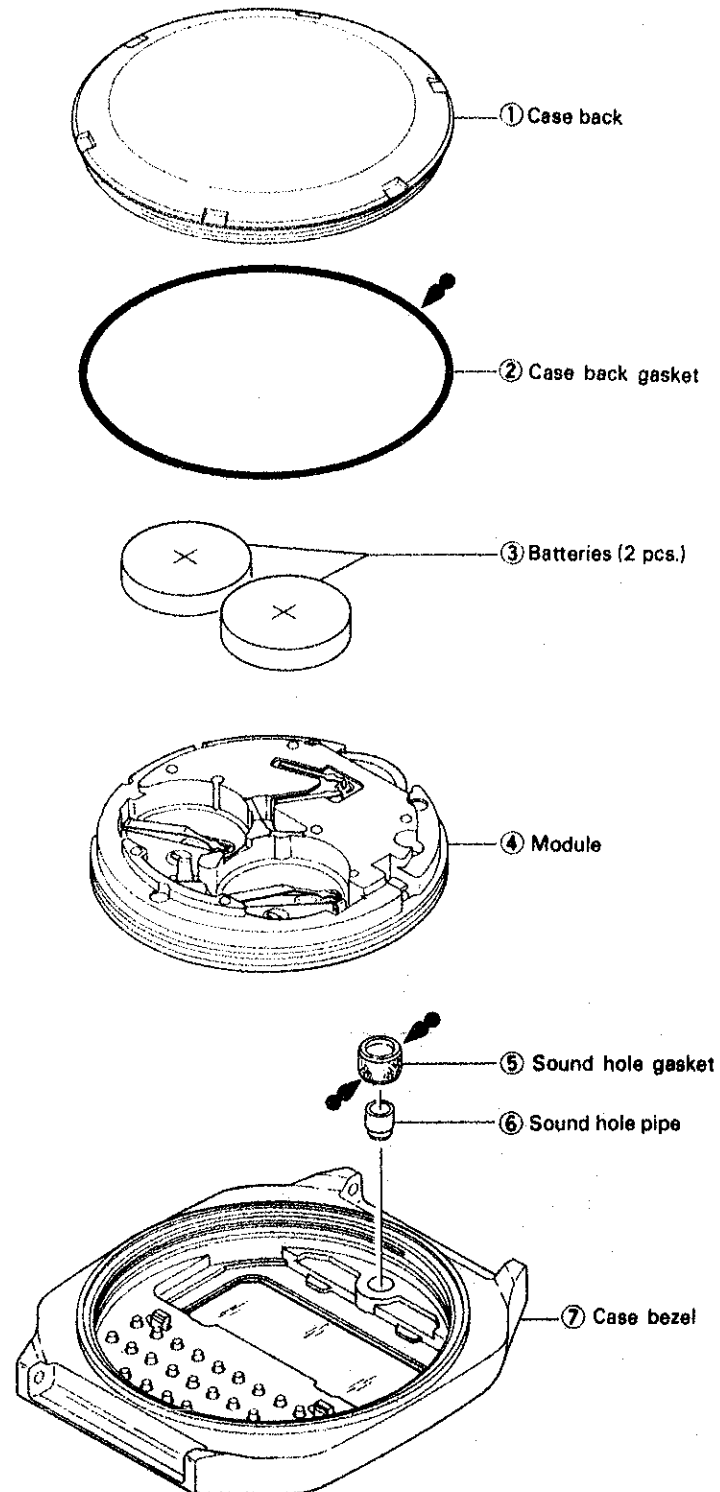
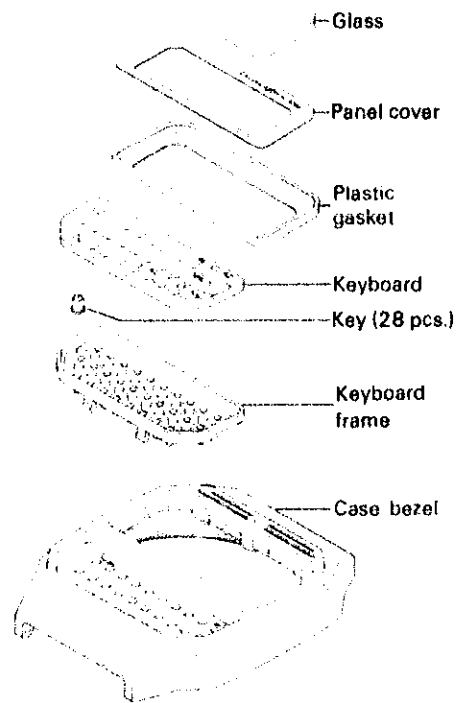

REMARKS FOR DISASSEMBLING AND REASSEMBLING

● CASE BACK

An insulation plate is fixed to the case back. Do not peel it off.

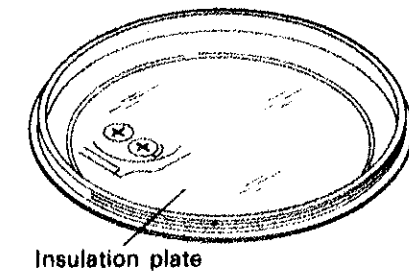

● Battery

- Set both batteries so that the plus polarities face up.
- Do not short-circuit the plus polarities of the batteries with tweezers, etc.

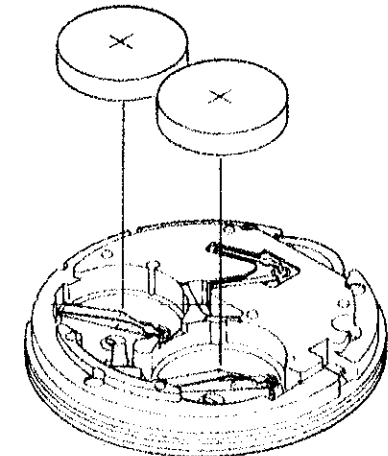

● WHEN INSTALLING BATTERIES IN Y739

The following may occur only when installing batteries.

- EX.:
- No display
 - Wrong display
 - Alarm does not stop.

To correct these abnormalities, do the following.

- 1) Depress the **AC** key several times.
The display changes to "0" and the watch returns to normal.
- 2) When an abnormality persists after depressing the **AC** key, connect the reset terminal to the battery connection ⊕ with tweezers. The display changes to "0" and the watch returns to normal.

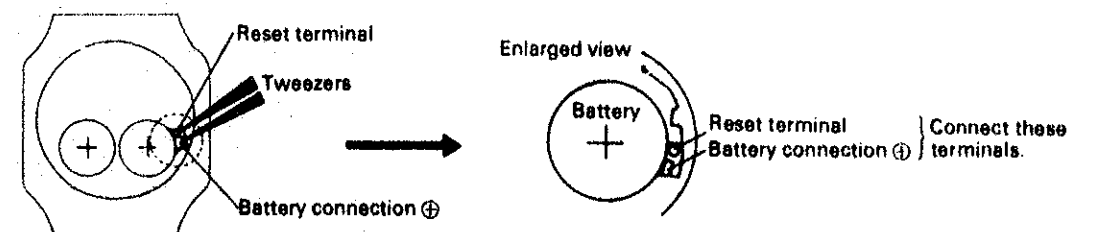
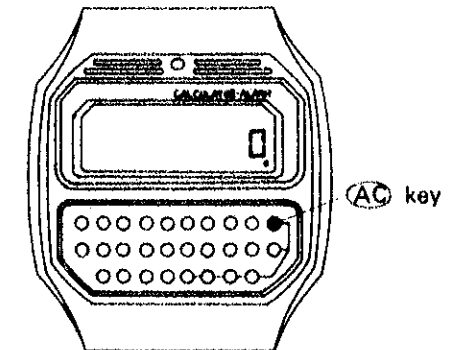

HOW TO REPLACE THE GLASS

● How to remove the glass

- Remove the glass with the tightening tool.
- (Inserting disk: Specialized for Y739A (S-162))
- (Supporting disk: $\phi 37.0 \sim \phi 38.0$)
- Place a vinyl sheet between the glass and the supporting disk as shown in the illustration on the right.
- Push only the glass with the inserting disk. Do not push the panel cover.
- When the watch is placed on the supporting disk with the glass and the inserting disk, use your hand to position the inserting disk and glass correctly and remove the glass.

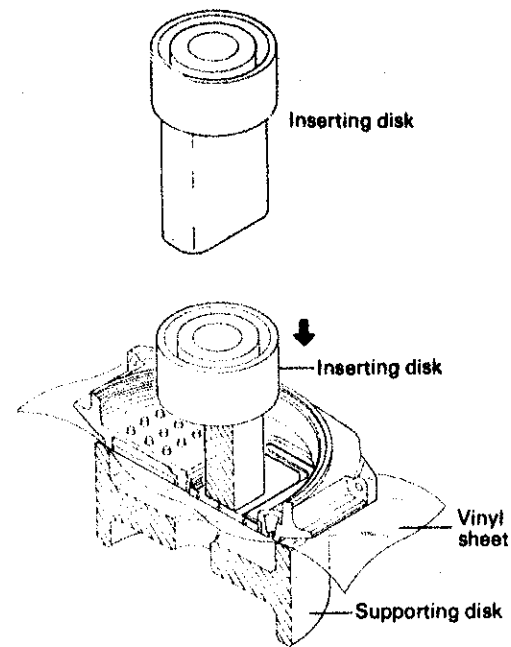

● How to insert the glass

- Set the panel cover in the plastic gasket.
- Place the glass in the plastic gasket together with the panel cover.
- Push the glass and plastic gasket in the case bezel.

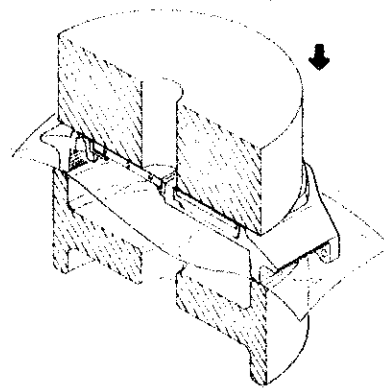

HOW TO REPLACE THE KEYBOARD

(Do not disassemble the keyboard unless it is to be replaced.)

● How to disassemble the keyboard

- Push the keyboard frame from the inside with tweezers.

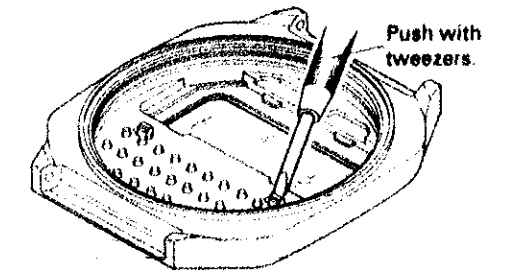

● How to reassemble the keyboard

- Invert the keyboard and insert the keys.

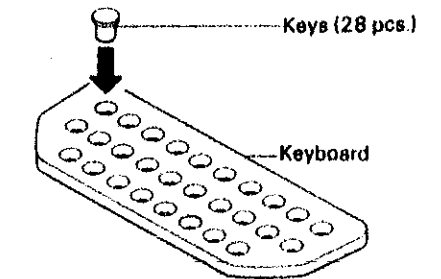

- Position the keyboard frame. Always use a new one.

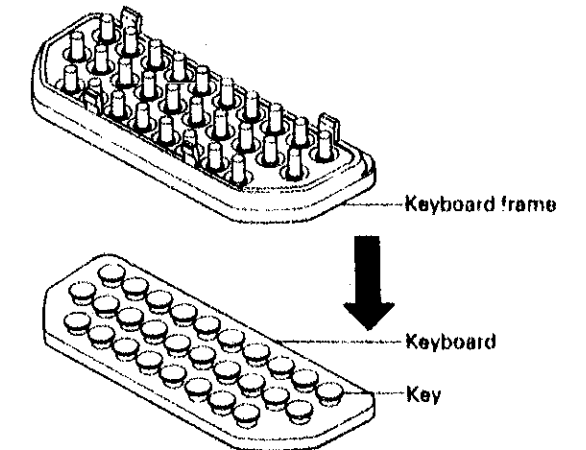

- Push the keyboard into the case bezel with the tightening tool.

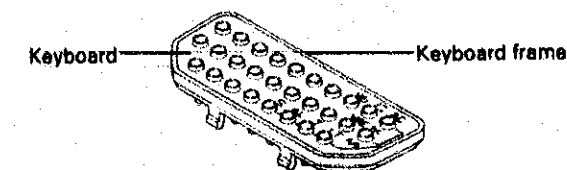
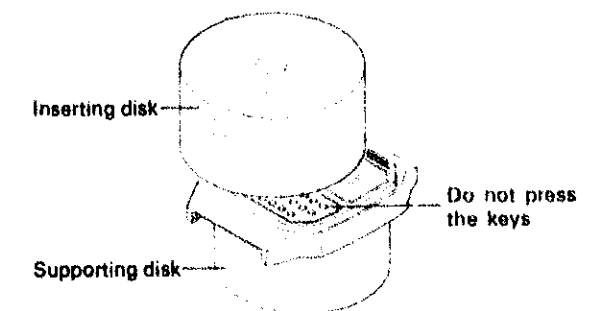
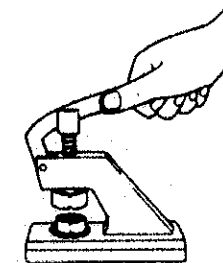

NOTE:

- Push in the keyboard until its top surface and the frame is flush.
- Always use fingercots.

2. DISASSEMBLING, REASSEMBLING AND LUBRICATION OF THE MODULE

Disassembling procedures Figs.: ① → ⑩

Reassembling procedures Figs.: ⑩ → ①

Lubrication: Silicon grease (500,000 c.s.)

Normal quantity 

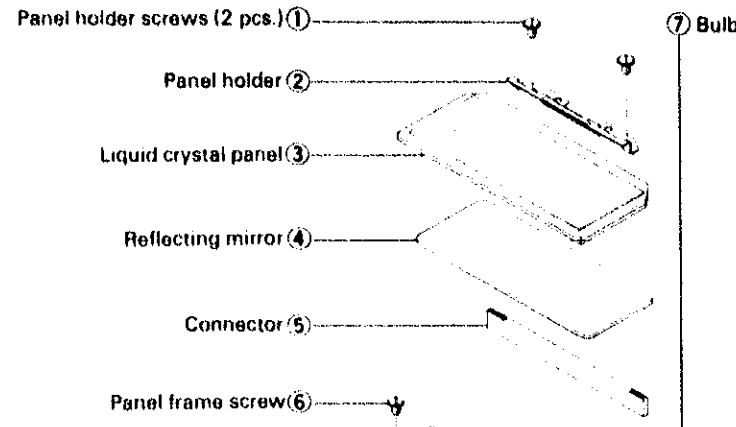

Notes on disassembling:

It is only necessary to remove the bulb when replacing it or cleaning the panel frame.

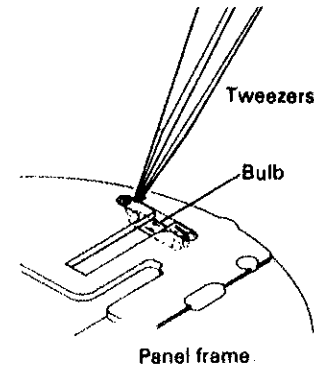

Bend the bulb leads with tweezers and remove the bulb.

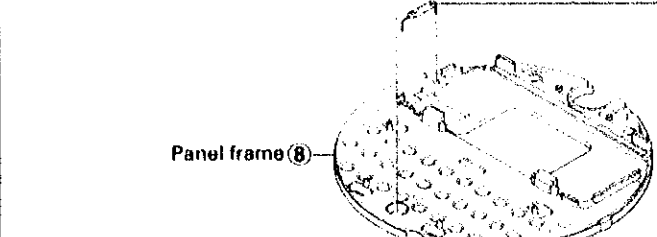

Notes on reassembling:
Place the pattern side downward.

⑪ Circuit block

Notes on disassembling:

Gradually disengage the pins with a screwdriver. Take care not to bend the circuit block.

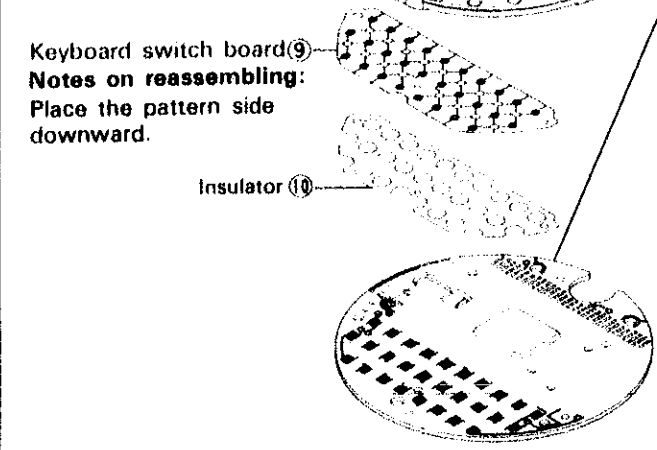
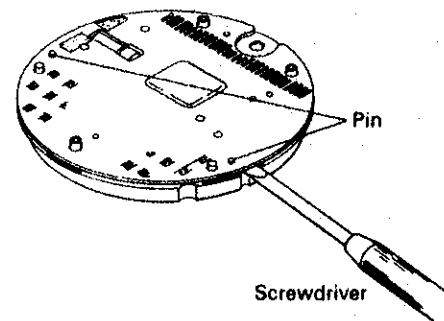



⑱ Speaker unit

Notes on reassembling:

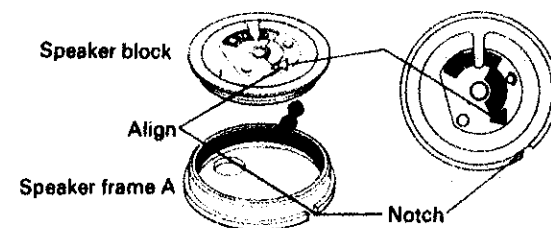
To install the speaker block, press the reverse side with a finger. Align the notch of speaker frame A with the arrow on the speaker block.

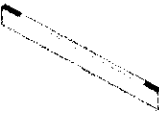

3. CLEANING

| Name of parts | Cleaning | Drying | Solution | Remarks |
|---|--|------------------|---------------------------------------|---|
| Connector  | Rinse or clean with a soft brush. | Warm air. | Alcohol | <ul style="list-style-type: none"> Check the contacting surface of the connector for stains. Never use benzene or trichloroethylene as these will melt the connector. Do not install a connector until it is completely dry. |
| Plastic parts Panel frame  | Rinse or clean with a soft brush. | Warm air. | Alcohol or Benzene | When cleaning the panel frame, remove the bulb. |
| Keyboard switch board Insulator | | | | |
| Metal parts (Screws, speaker lead terminals, etc.) | Clean with a cleaner (rinse or clean with a soft brush). | Warm or hot air. | Alcohol, Benzene or Trichloroethylene | |

• PARTS THAT MUST NOT BE CLEANED

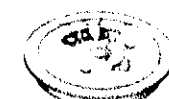
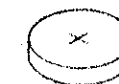
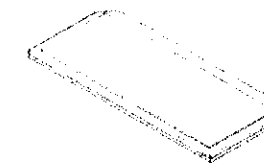
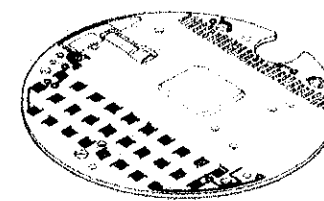

- Clean only the contacts of the liquid crystal panel and circuit block with a cloth moistened with benzene and blow dry with warm air.
- Remove dust or lint with a soft brush.
- Do not scratch the surface of the reflecting mirror.

V. CHECKING AND ADJUSTMENT

Be sure to use the static electricity protector when handling the module.

1. Guide table for checking and adjustment

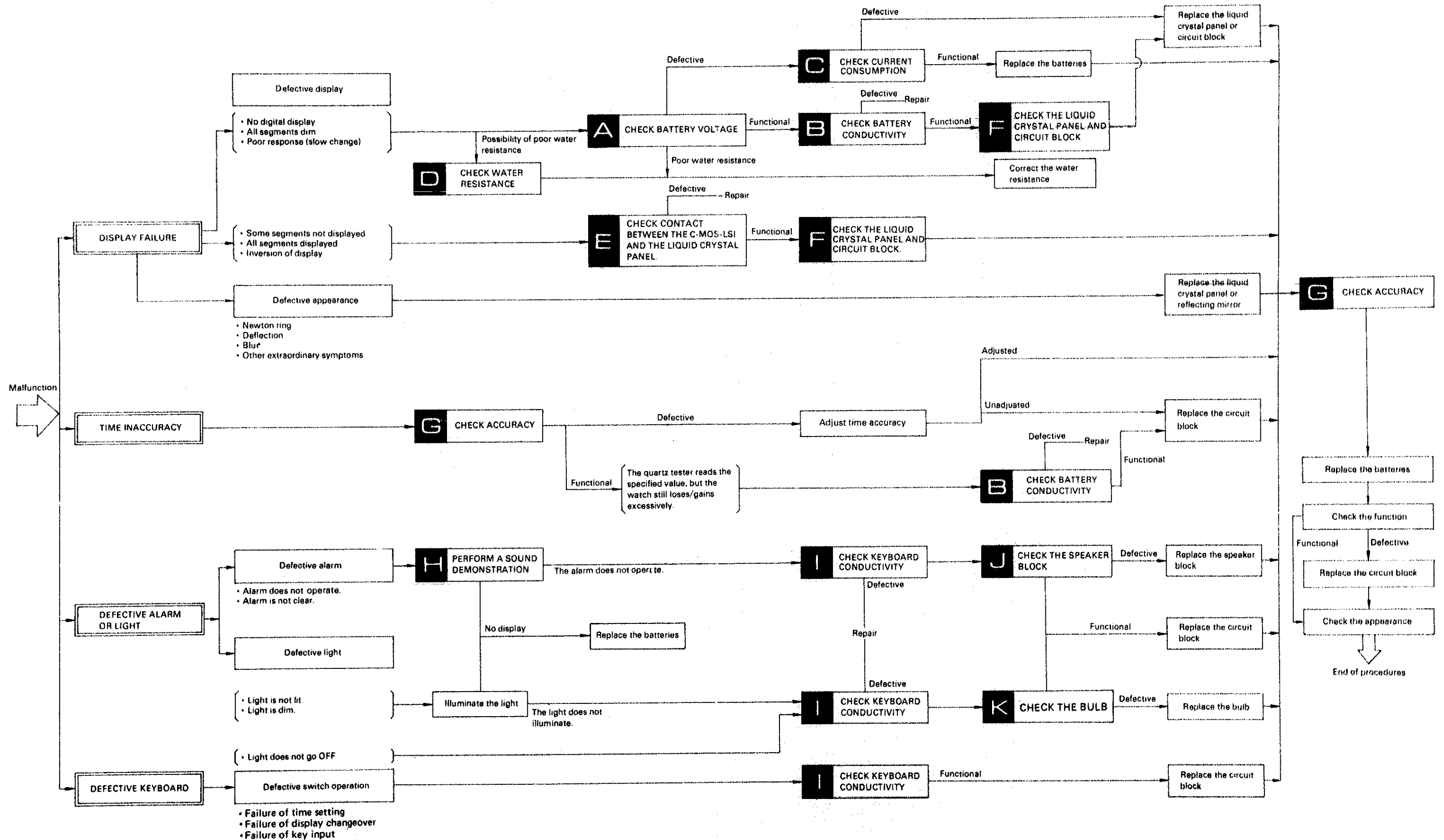

2. Relationship between the segments (Liquid crystal panel electrode) and C-MOS-LSI output terminal

A complete knowledge of how the segments (Liquid Crystal Panel Electrode) connect with the C-MOS-LSI output terminals is necessary for proper checking and adjustment.

● Designation of segment

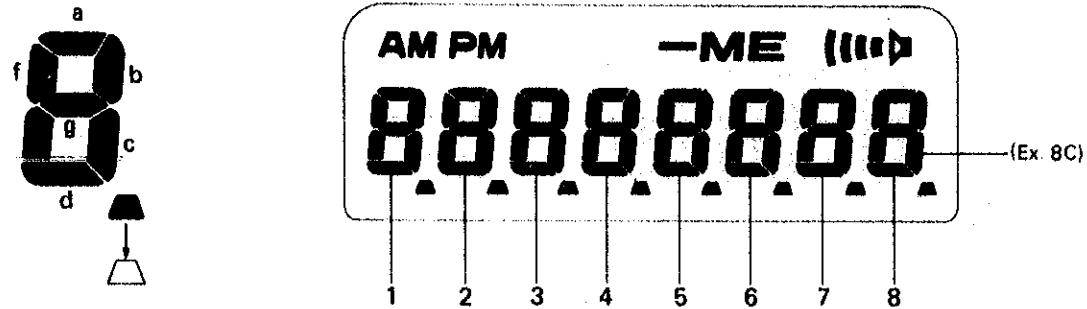

● Relationship between the segments and the C-MOS-LSI output terminal

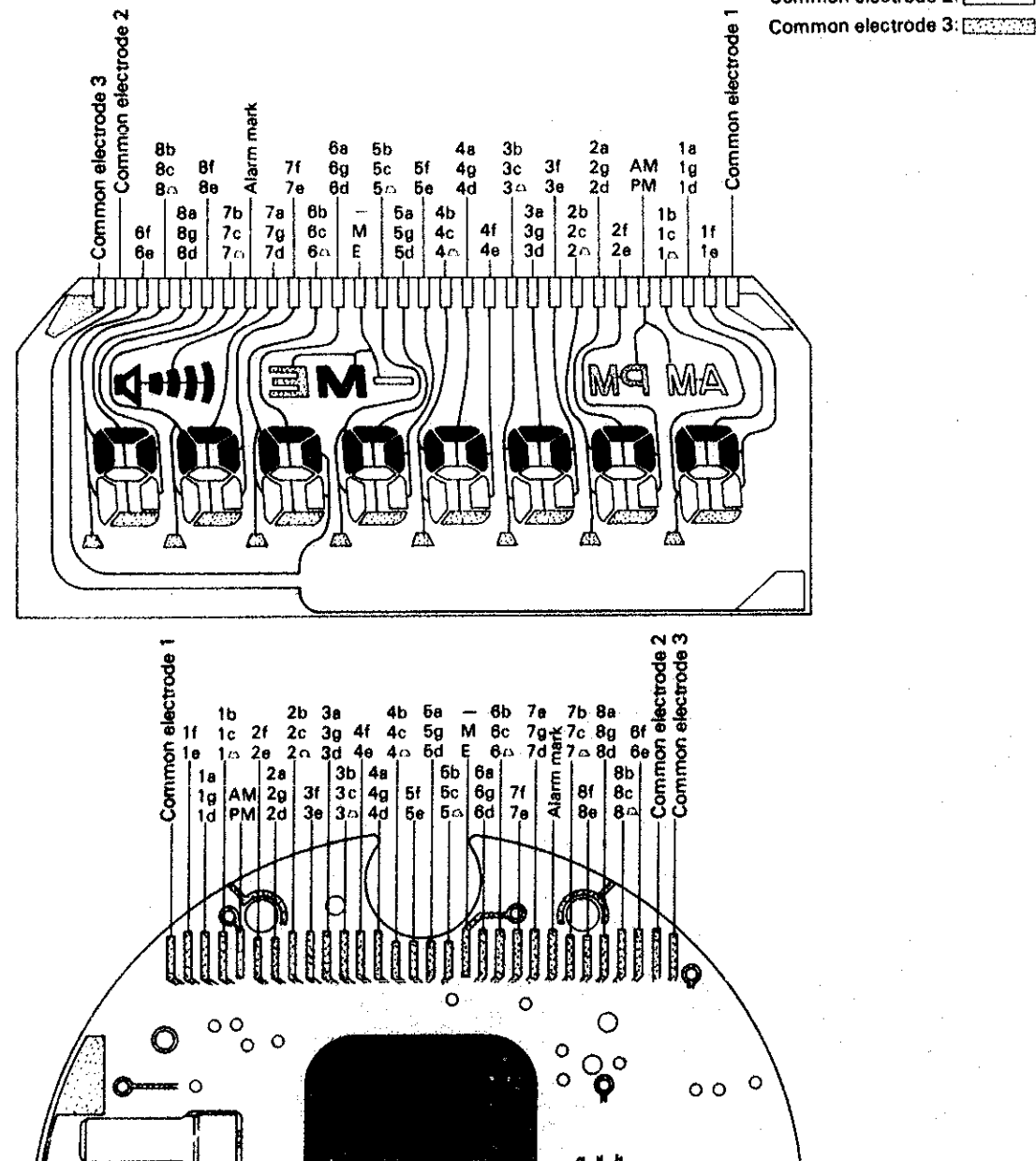

3. Procedures for checking and adjustment

| | Procedure | Result and repair |
|---|---|--|
| CHECK BATTERY VOLTAGE | <p>Check the battery voltage (Check both batteries).</p> <p>1) Set up the Volt-ohm-meter. Range to be used: DC 3V</p> <p>2) Measuring</p> <ul style="list-style-type: none"> ● Red probe..... Battery surface ⊕ ● Black probe..... Battery surface ⊖ <p>Note:</p> <ul style="list-style-type: none"> ● Always use bamboo or plastic tweezers for handling the batteries. ● When there is battery electrolyte leakage, refer to "HOW TO CHECK BATTERY ELECTROLYTE LEAKAGE AND REPAIR" below for repairing. | <p>1.5V or more Normal</p> <p>Less than 1.5V Defective</p> |
| HOW TO CHECK BATTERY ELECTROLYTE LEAKAGE AND REPAIR | <p>1. Remove the module from the case.</p> <p>2. Disassemble the module.</p> <p>3. Wipe off battery electrolyte on the circuit block.</p> <p>1) Wipe off battery electrolyte with a cloth moistened with distilled water. If distilled water is not available, use tap water.</p> <p>Note:</p> <ul style="list-style-type: none"> ● Do not expose the trimmer condenser to water or alcohol, which may result in a change in its capacity and eventually in the time accuracy. ● Do not use a cloth which gives off lint such as gauze, flannel, etc. <p>Take care to clean the connecting portions shown below.</p> <p>Battery side Liquid crystal panel side</p> <p>2) Wipe with a cloth moistened with alcohol. (If the cleaned portions remain wet with water, they will corrode with rust.)</p> <p>3) Dry with warm air by using a dryer.</p> <p>Note: Do not raise the temperature excessively.</p> <p>4) Clean the other parts (battery connections (+/-), circuit block holder, battery lead terminal) which come in contact with the electrolyte.</p> <p>a) Wipe off battery electrolyte on the other parts with a soft brush moistened with distilled water. (If distilled water is not available, use tap water.)</p> <p>b) Rinse with alcohol.</p> <p>c) Dry with warm air by using a dryer.</p> <p>5) Reassemble the module. Replace the batteries.</p> <p>6) Check the function and current consumption.</p> | |

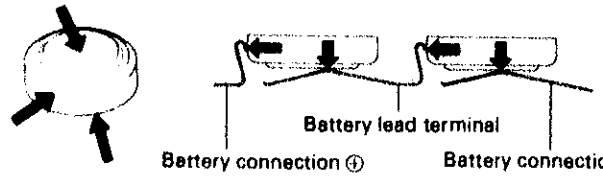
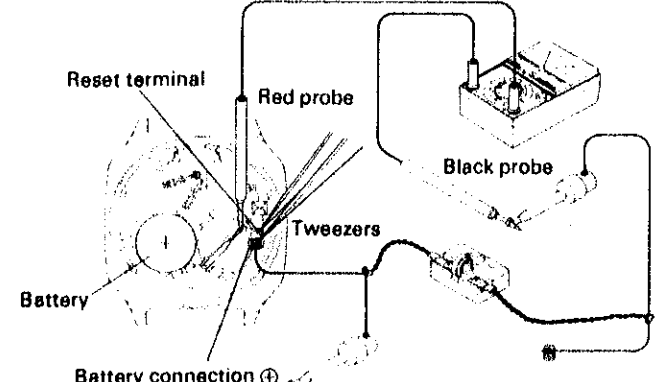
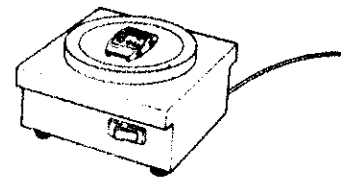
| | Procedure | Result and repair |
|----------------------------|--|---|
| CHECK BATTERY CONDUCTIVITY | <p>Check to see if battery power is supplied to the circuit. Check the batteries, battery connections (+/-) and battery lead terminal for contamination.</p>  <p>Note: Do not bend the battery connections.</p> | <p>No contamination Normal Contamination Defective - Clean -</p> |
| CHECK CURRENT CONSUMPTION | <p>Check to see if current consumption is normal. (1) Measure the total current consumption of the module.</p> <ol style="list-style-type: none"> 1) Set up the Volt-ohm-meter. Range to be used: DC 12μA 2) Measuring <ol style="list-style-type: none"> i) a) Set one battery. b) Connect the power supplier to the other battery connections as shown in the illustration below. c) Short-circuit the reset terminal and battery connection ⊕ with tweezers. This ensures that the circuit block functions when power is supplied.  <ol style="list-style-type: none"> ii) Place the battery in the other battery compartment and perform items a), b) and c). Compare the larger of the measured values with the specified value at right. <p>(2) Measure the current consumption of the circuit block. Remove the liquid crystal panel and check to see if the current consumption is normal. Follow the same current consumption measuring method in (1).</p> | <p>Less than 7.0 μA Normal Replace the batteries. More than 7.0 μA Defective Proceed to C 2.</p> <p>More than 6.0 μA Defective Proceed to Replace the circuit block. Less than 6.0 μA Functional Proceed to Replace the liquid crystal panel.</p> |
| CHECK WATER RESISTANCE | <p>Check for moisture in the watch.</p> <ol style="list-style-type: none"> 1) Place the watch on a hot plate from 35°C to 45°C (95°F to 113°F) and heat it for 15 minutes.  <ol style="list-style-type: none"> 2) Check to see that the glass does not collect moisture. | <p>Does not collect moisture Normal Proceed to [] Collects moisture Defective Repair</p> |

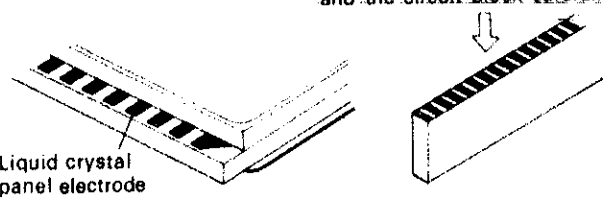
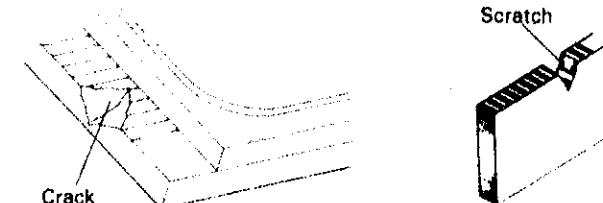
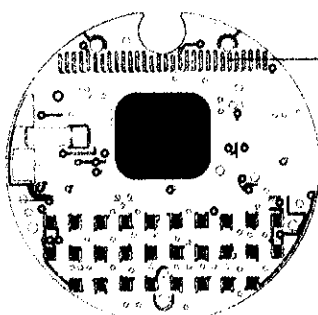
| | Procedure | Result and repair |
|---|--|---|
| CHECK CONTACT OF C-MOS-LSI ~ LIQUID CRYSTAL PANEL | <p>After removing the liquid crystal panel, check for poor conductivity of the liquid crystal panel, connector and C-MOS-LSI output terminal whose segments are found to be defective in "CHECK PATTERN SEGMENT CHECKING SYSTEM". (Refer to "Relationship between the segment and the C-MOS-LSI output terminal" on Page 14.) Use a microscope for checking.</p> <ol style="list-style-type: none"> (1) Check for dust, lint and other contamination on the liquid crystal panel electrode and connector. Be sure to check the connecting portion of the liquid crystal panel and the circuit block carefully.  <ol style="list-style-type: none"> (2) Check for scratches, cracks and breaks of the liquid crystal panel and connector.  <ol style="list-style-type: none"> (3) Check for dust, lint and other contamination on the output terminal of the circuit block.  | <p>Uncontaminated Normal Proceed to E (2). Contaminated Defective Wipe off any foreign matter.</p> <p>No scratches, cracks or breaks. Normal Proceed to E (3). Scratched, cracked or broken: Defective Replace the parts with new ones.</p> <p>Uncontaminated Normal Proceed to E. Contaminated Defective Wipe off any foreign matter</p> |
| CHECK LIQUID CRYSTAL PANEL AND CIRCUIT BLOCK | <p>Check to see if the liquid crystal panel and the circuit block function correctly. (Refer to "Relationship between the segment and the C-MOS-LSI output terminal on page 14.)</p> <ol style="list-style-type: none"> (1) Check liquid crystal panel. <ol style="list-style-type: none"> 1. Set up the Volt-ohm-meter. Range to be used: OHMS R × 1 ~ R × 1K <p>Note: Any range can be used if more than 3V is applied to the probes of the Volt-ohm-meter. If the output voltage of the Volt-ohm-meter is less than 3V, change the range to one which is higher in resistance (R × 10k).</p> <ol style="list-style-type: none"> 2. Remove the liquid crystal panel from the module and turn it to the reverse side. | |

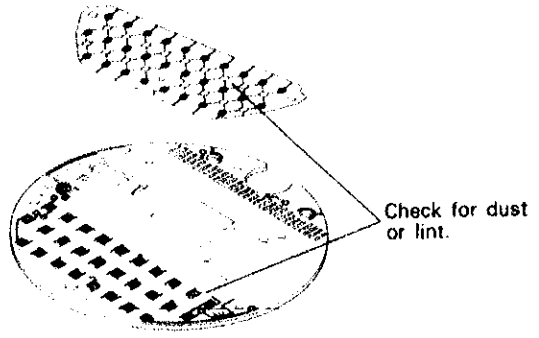
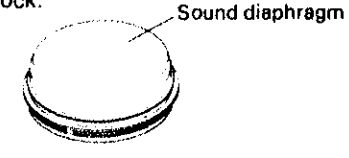
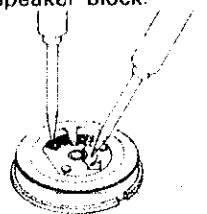
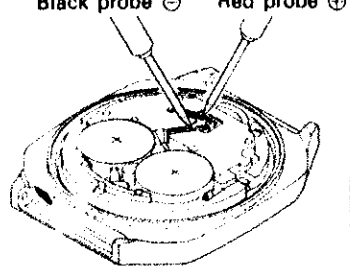
| | Procedure | Result and repair |
|------------------------------------|--|---|
| CHECK CONDUCTIVITY OF THE KEYBOARD | <p>1. Check the keyboard for dust or lint.</p> <p>2. Check the keyboard pattern of the keyboard switch board and circuit block.</p>  | <p>No dust or lint Normal The alarm does not sound → J No illumination → K</p> <p>Dust or lint Defective Wipe off any foreign matter lightly with a cloth moistened with cleaning solution.</p> |
| CHECK SPEAKER BLOCK | <p>Always use non-magnetic tweezers to handle the speaker block.</p> <p>(1) Check to see if the battery connections are securely in contact with the speaker lead terminals.</p> <p>(2) Check for any dust and scratches on the sound diaphragm of the speaker block.</p>  <p>(3) Check for any broken coil wire and short-circuit of the coil of the speaker block.</p> <p>1. Set up the Volt-ohm-meter. Range to be used: OHMS R × 1</p> <p>2. Measuring Apply the probes of the Volt-ohm-meter to the lead terminals of the speaker block.</p>  <p>(4) Check to see if the output signal of the circuit block is transmitted to operate the speaker block.</p> <p>1. Set up the Volt-ohm-meter. Range to be used: DC 3V</p> <p>2. Attach the electricity supplier to the module.</p> <p>3. Set the alarm and operate it.</p> <p>4. Measuring Apply the probes of the Volt-ohm-meter to the output terminals of speaker terminals A and B as shown in the illustration.</p>  <p>Note: Do not disengage the batteries.</p> | <p>No dust or lint Normal Proceed to K (2).</p> <p>Dust or lint Defective Clean with a cloth moistened with cleaning solution.</p> <p>Cracked Defective Replace the speaker block.</p> <p>30 ~ 150Ω Normal Proceed to K (3).</p> <p>Less than 30Ω or more than 150Ω Defective Replace the speaker block.</p> <p>Swings Normal Replace the speaker block.</p> <p>Does not swing Defective Replace the circuit block.</p> |

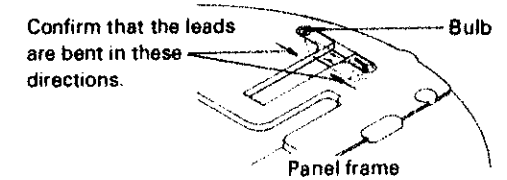
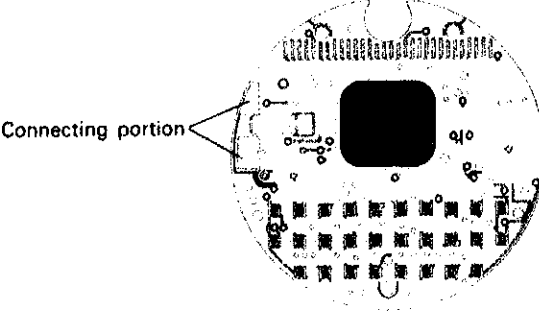
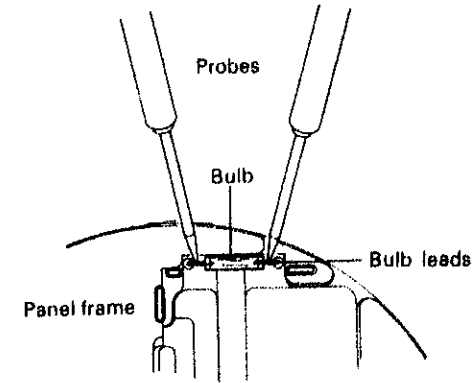
| | Procedure | Result |
|----------------------|--|--|
| CHECK BULB CONDITION | <p>Check bulb condition.</p> <p>(1) Remove the panel frame and confirm that the leads of the bulb are bent to the circuit block pattern side.</p>  <p>(2) Check for any contamination of the connecting portion between the bulb lead terminal and circuit block.</p>  <p>(3) Check to see if there is a broken filament in the bulb.</p> <p>1. Set up the Volt-ohm-meter. Range to be used: OHMS R × 1</p> <p>2. Measuring Apply the two probes of the Volt-ohm-meter to the bulb leads as shown in the illustration.</p>  | <p>Bent Normal Proceed to K (2).</p> <p>Unbent Defective -- Correct --</p> <p>No contamination Normal Proceed to K (3).</p> <p>Contamination Defective -- Clean --</p> <p>Bulb lights up Normal Replace the circuit block.</p> <p>Bulb does not light up Defective -- Replace --</p> |

All procedures of Disassembling and Reassembling and Adjustment are completed

VI. PARTS LIST OF MODULE

| Y739A | | | |
|----------|-------------------------------------|------------------|-----------------------------------|
| PART NO. | PART NAME | PART NO. | PART NAME |
| 4001 815 | Circuit block | 4510 600 | Liquid crystal panel |
| 4216 816 | Insulator | 4521 740 | Reflecting mirror |
| 4242 815 | Speaker lead terminal A | ☆ 4530 649 | Bulb |
| 4242 816 | Speaker lead terminal B | 4540 815 | Liquid crystal panel holder |
| 4242 817 | Plus terminal of battery connection | 4580 590 | Speaker block |
| 4242 818 | Battery connection ⊖ | 4991 590 | Gasket for speaker block |
| 4270 815 | Battery connection ⊕ | 022 340 | Liquid crystal panel holder screw |
| 4293 815 | Switch cock | 022 340 | Liquid crystal panel frame screw |
| 4313 815 | Connector | ☆ U.C.C. 389 | Silver oxide battery |
| 4398 815 | Liquid crystal panel frame | ☆ Maxell SR1130W | |
| 4398 816 | Speaker block frame | SEIZAIKEN | |
| 4410 615 | Circuit bridge plate | TR1130W | |

Remarks:

Bulb
 ☆ 4530 649 Bulb replacement requires soldering a new bulb to the circuit. After soldering the bulb pins in position, cut off any excess parts.

Battery
 ☆ U.C.C. 389
 ☆ Maxell SR1130W
 SEIKO SEIZAIKEN
 TR1130W
) An additional battery for this calibre might be added as a substitute in the future.

☆ ○ Please see remarks.