

TECHNICAL GUIDE

CAL. Y661A
CAL. Y662A

DIGITAL QUARTZ

CONTENTS

I. SPECIFICATIONS.....	1
II. CIRCUIT BLOCK SCHEMATIC.....	1
III. DISASSEMBLING, REASSEMBLING AND LUBRICATING OF CASE.....	2
IV. DISASSEMBLING AND REASSEMBLING.....	3
1. Liquid crystal panel.....	3
2. Switch component mechanism.....	4
V. CLEANING.....	5
VI. CHECKING AND ADJUSTMENT.....	7
1. Guide table for checking and adjustment.....	7
2. Procedure for checking and adjustment.....	8
A. Check battery voltage.....	8
B. Check conductivity of liquid crystal panel, circuit block and connector.....	8
C. Check circuit block.....	8
D. Check current consumption.....	9
E. Check accuracy.....	9
F. Check speaker block.....	9
G. Check conductivity of switch component.....	10
H. Check functioning.....	10
I. Others.....	11

I. SPECIFICATIONS

Item	Cal. No.	Y661A	Y662A
Display medium		Nematic Liquid Crystal, FEM (Field Effect Mode)	
Liquid crystal panel drive system		Multiplex	
Display system		● Time function	
		● Alarm function	
		● Stopwatch function	● Timer function
Additional mechanism		* Auto calendar (leap year system) * Sound demonstration * Time signal function	
Los/gain		Mean monthly rate at normal temperature range: Less than 20 seconds	
Casing diameter		φ 17.5 mm	
Height		4.4 mm (5.0 mm including battery)	
Regulation system		Trimmer condenser	
Quartz tester measuring gate		Any gate is available	
Battery		Silver oxide battery: MAXELL SR721W Battery life: Approx. 2 years Voltage: 1.55V	

II. CIRCUIT BLOCK SCHEMATIC

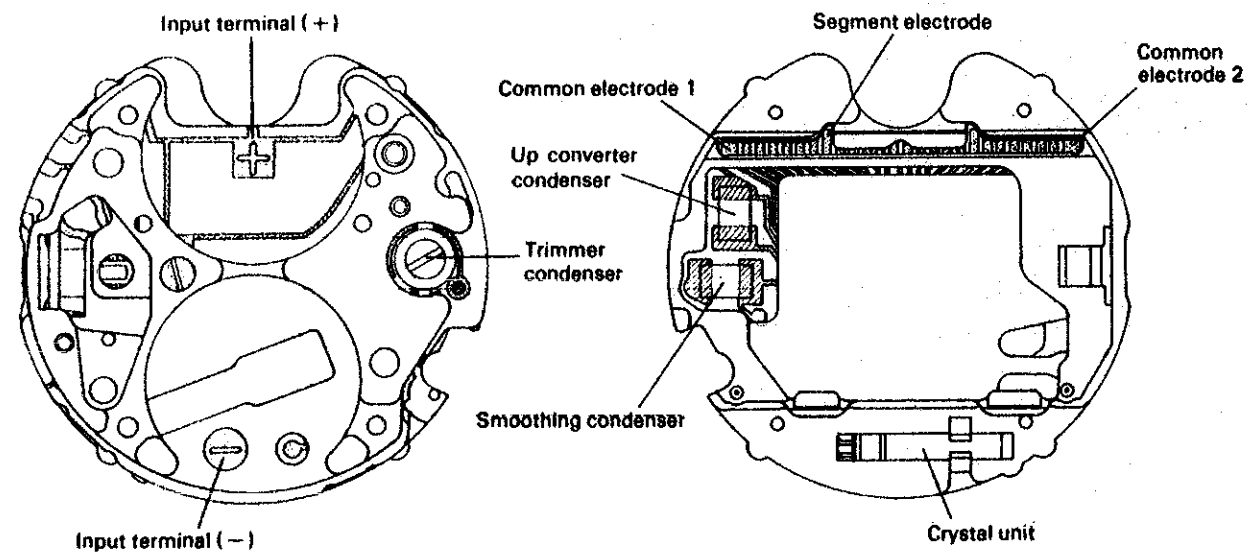

Described above is the circuit block of Y661A. The difference between Y661A and Y662A is the input terminal (+).

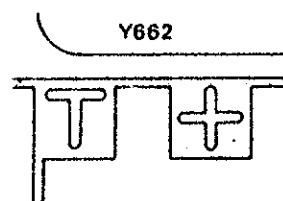

III. DISASSEMBLING REASSEMBLING AND LUBRICATING OF CASE

Disassembling procedures: Figs. ①→⑥
 Reassembling procedures: Figs. ⑥→①
 Lubricant: Moebius Synt-V-Lube
 Never Lubricate the portions marked ⊗
 Quantity: Standard quantity ●

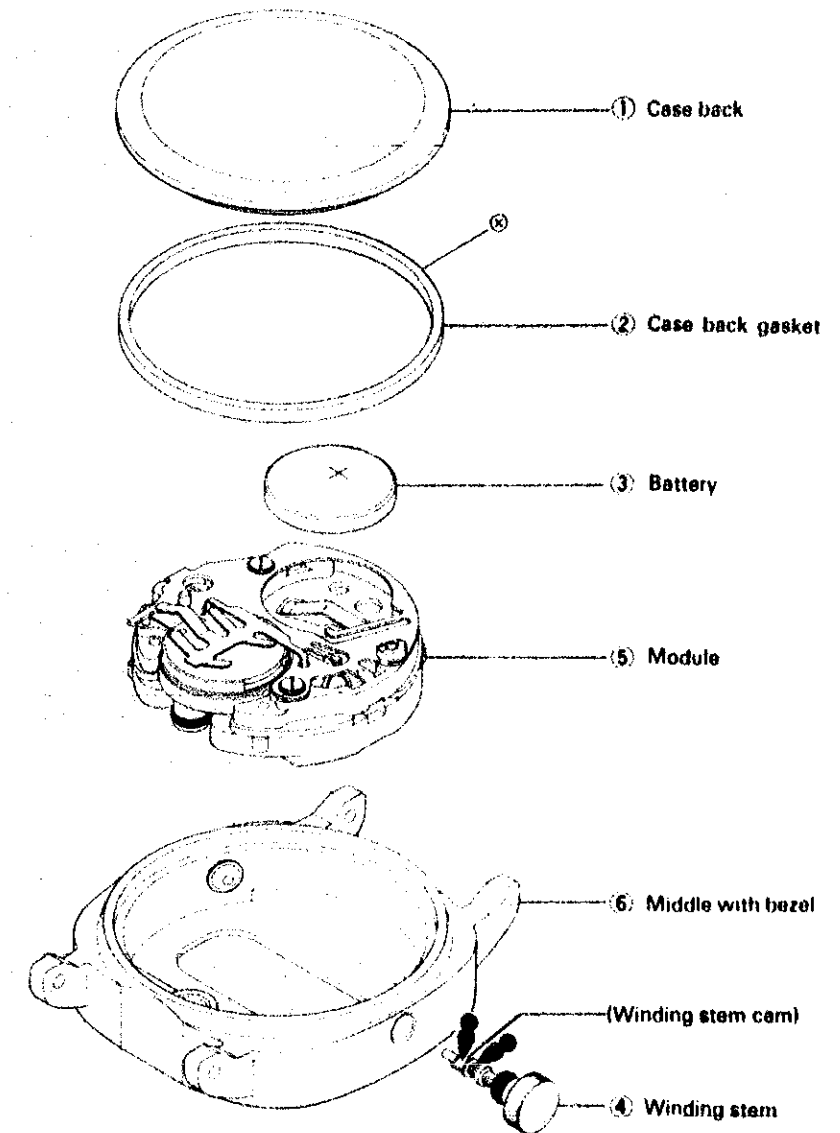

④ Winding Stem

When removing/installing winding stem, depress the punched part of the winding stem retainer downward with tweezers. The winding stem has a cam which activates the switch lever. Insert the winding stem so that the cam is placed horizontally.

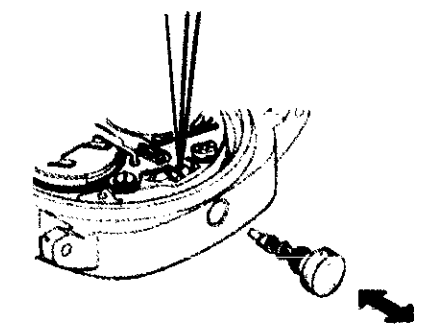
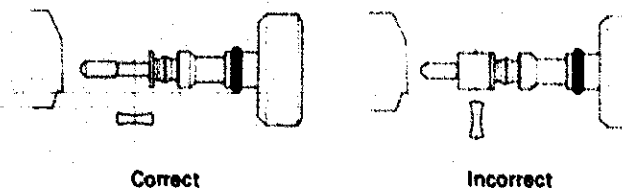

IV. DISASSEMBLING AND REASSEMBLING

Disassembling procedures: Figs. ①→⑩

Reassembling procedures: Figs. ⑩→①

1. Liquid crystal panel

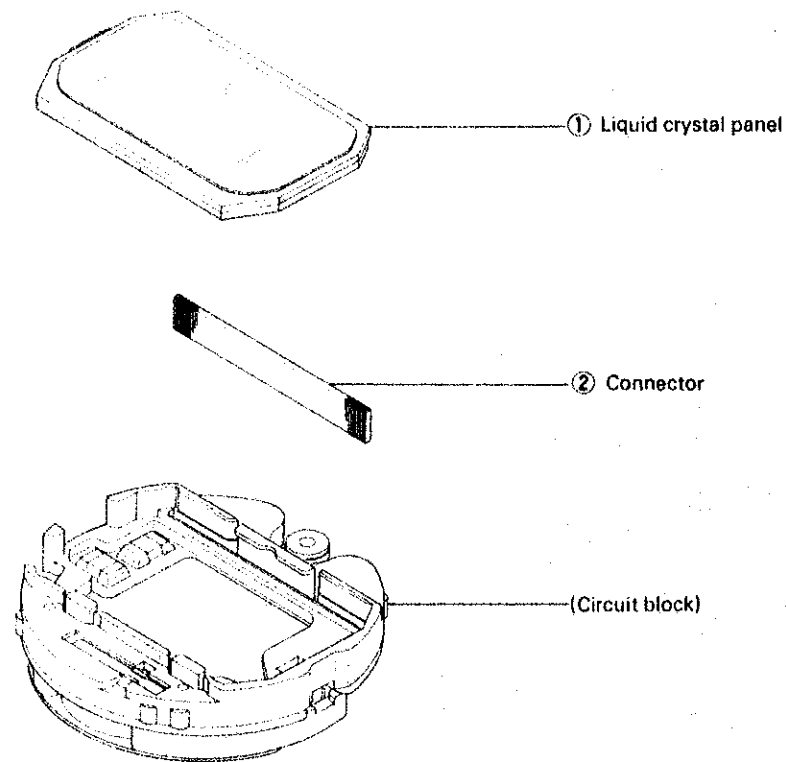

① Liquid crystal panel

* How to remove the liquid crystal panel

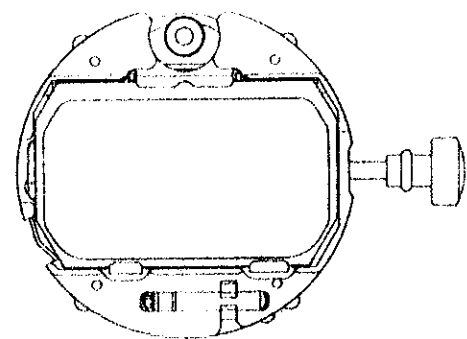

● Push the liquid crystal panel frame (arrowed portions ●) outward (in the arrowed direction ◻) with tweezers and remove the liquid crystal panel, being careful not to scratch it.

* How to install the liquid crystal panel

First, insert the end of the liquid crystal panel (6 o'clock position). Then, insert the other end of the liquid crystal panel (12 o'clock position).

After inserting the liquid crystal panel, depress the panel frame (arrowed portions ●) inward.

2. Switch component mechanism

③ Speaker block fixing spring
When removing/installing the speaker block fixing spring, always hold the bent portion with tweezers.

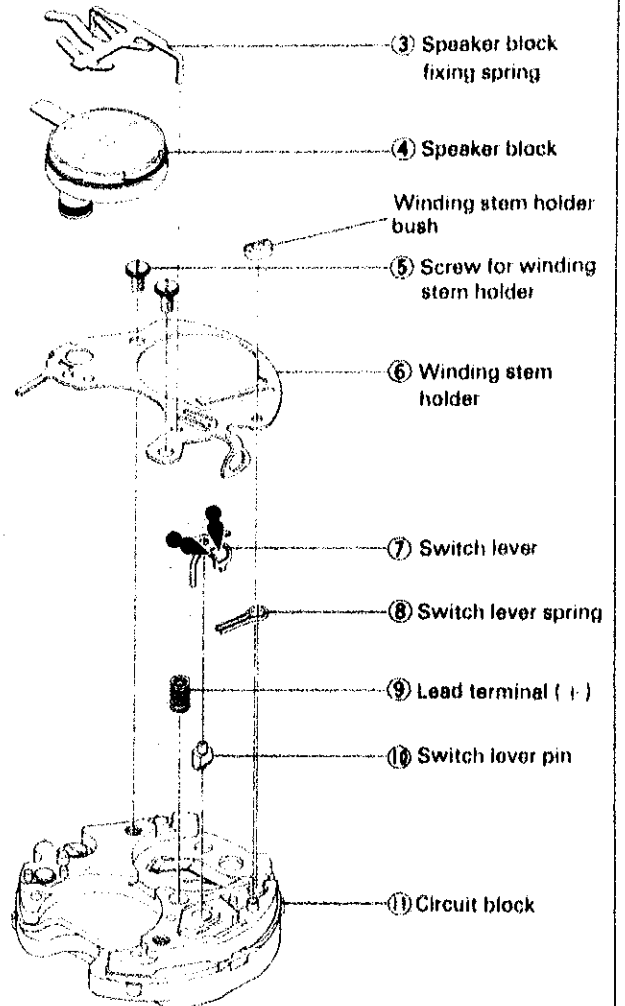

⑦ Switch lever
Install the switch lever as shown in the illustration below.

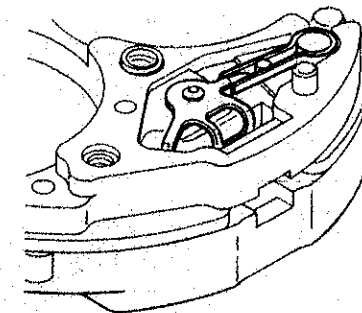

⑩ Switch lever pin
The switch lever pin has a flat portion. When installing the switch lever pin, align the flat portion of the switch lever pin with that of the circuit block.

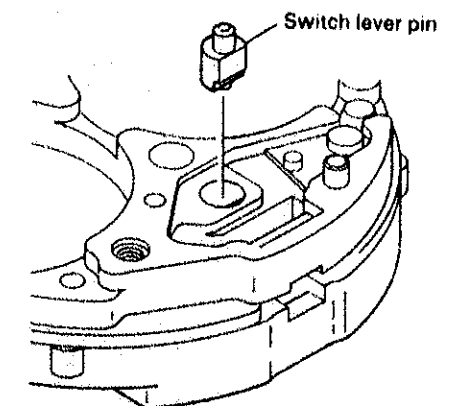

V. CLEANING

Clean the parts in accordance with the method shown in the table below.

1. How to clean

Name of Parts	Cleaning	Drying	Solution	Remarks
Connector	Rinse or wash with a soft brush	Warm air	Alcohol	<ul style="list-style-type: none"> ● Clean the contacting portion between the connector and liquid crystal panel and circuit block. ● Never use benzene or trichloroethylene as these will melt the parts.
Plastic parts	Rinse or wash with a soft brush	Warm air	Alcohol, or benzene	
Others (Except parts that must not be cleaned)	Rinse and wash with a cleaner or wash with soft brush.	Warm or hot air	Benzene, or alcohol	

2. Parts that must not be cleaned

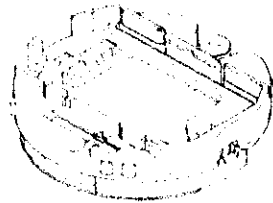

Circuit block



Liquid crystal panel

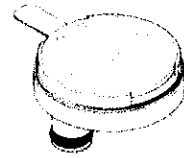

Speaker block



Battery

- Only the conductive portions should be wiped with a cloth moistened with benzene and dried with warm air.
- Remove dust and lint with a brush.
- Be careful not to scratch the front surface of the reflecting mirror.

VI. CHECKING AND ADJUSTMENT

1. Guide table for checking and adjustment

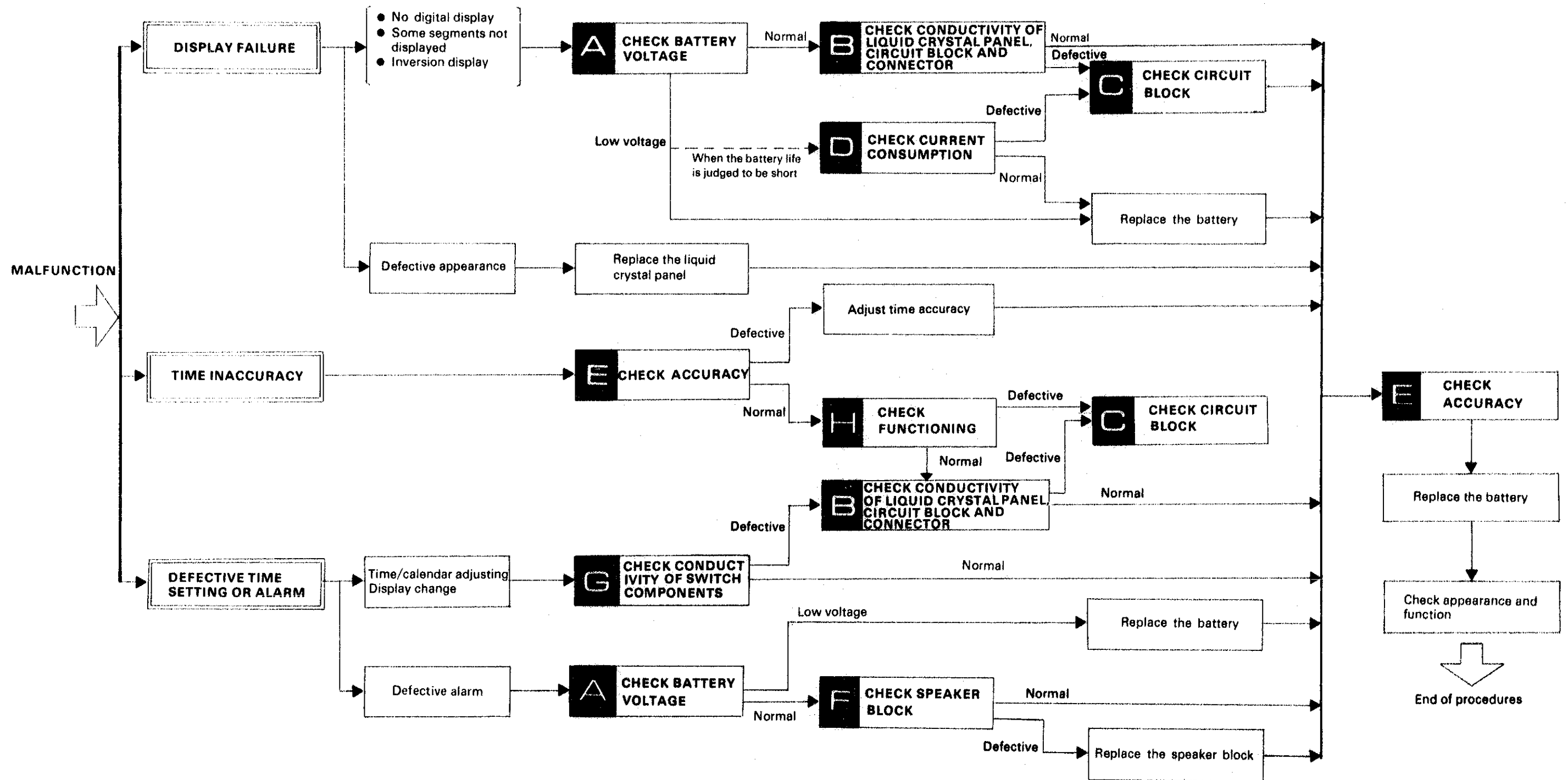

2. Procedure for checking and adjustment

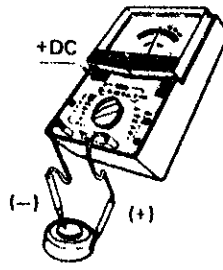
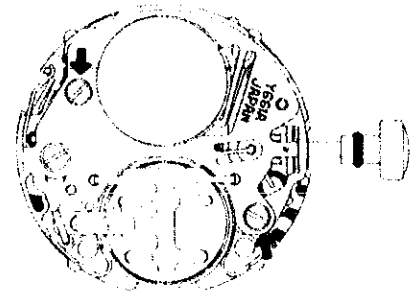
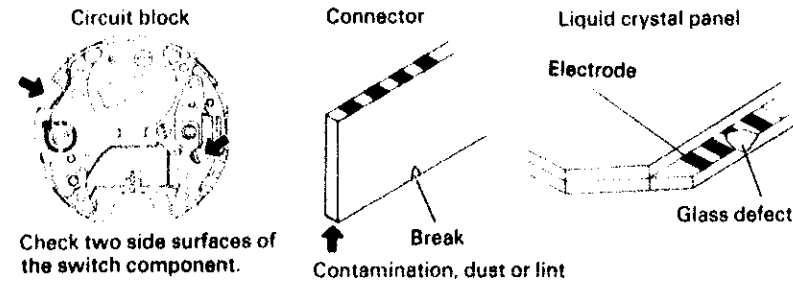
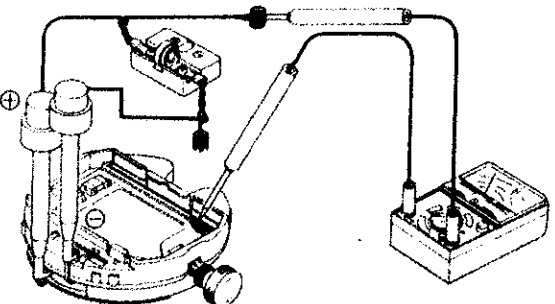
	Procedure	Result and repair
CHECK BATTERY VOLTAGE	<p>Use the following procedures to check battery voltage.</p> <ol style="list-style-type: none"> Set up the Volt-ohm-meter. Range to be used: DC3V Measuring Red probe ⊕..... Battery surface ⊕ Black probe ⊖..... Battery surface ⊖ 	<p>1.5V or more: Normal Less than 1.5V: Defective Replace the battery.</p>
CHECK CONDUCTIVITY OF LIQUID CRYSTAL PANEL, CIRCUIT BLOCK AND CONNECTOR	<ol style="list-style-type: none"> Check the screws for tightness.  Check for dust, lint, other contamination, scratches, cracks and breaks of the conductive portions.  	<p>No loose screws: Normal Loose screws: Defective Retighten the screws. Contaminated: Defective Wipe off any foreign matter.</p> <p>No scratches, cracks or breaks: Normal Scratched, cracked or broken: Defective Replace with a new one.</p>
CHECK CIRCUIT BLOCK	<p>Check that the electric signal flows into the connector from the circuit block correctly.</p> <ol style="list-style-type: none"> Remove the Liquid crystal panel, connector and speaker block from the module. Supply the voltage power. Set up the Volt-ohm-meter. Range to be used: DC3V Measuring Red probe ⊕..... Power supply ⊕ terminal Black probe ⊖..... Segment electrode 	<p>0.8V or more: Normal Less than 0.8V: Defective Replace the circuit block.</p>

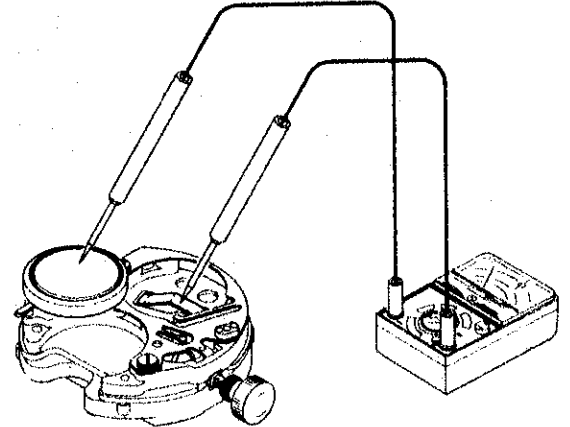
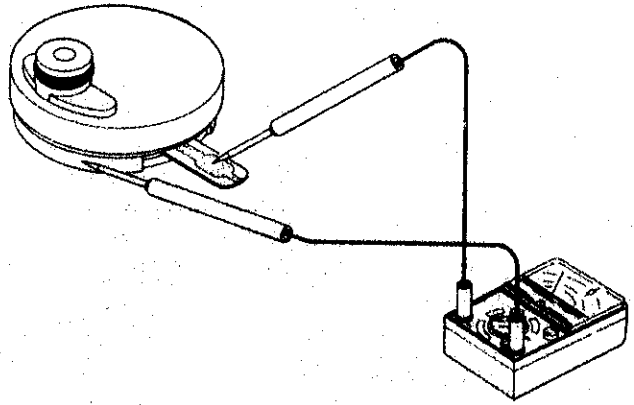
	Procedure	Result and repair
CHECK CURRENT CONSUMPTION	<p>Check that the current consumption is normal.</p> <ol style="list-style-type: none"> Set up the Volt-ohm-meter. Range to be used: DC12μA Measuring Red probe ⊕..... Battery connection ⊖ Black probe ⊖..... Battery surface ⊖  <p>*Checking method when the current consumption is large Measure the current consumption of only circuit block.</p>	<p>1.5μA or less: Normal More than 1.5 μA: Defective Replace circuit block or liquid crystal panel.</p> <p>1.3μA or less (Circuit block is normal.): Defective Replace the liquid crystal panel. More than 1.3μA (Circuit block is defective.): Defective Replace the circuit block.</p>
CHECK ACCURACY	<p>Check gain or loss of time.</p> <ol style="list-style-type: none"> Set up the Quartz tester. Use an electromagnetic field microphone for liquid crystal panel watch. Set the watch on the microphone and measure the accuracy. If the accuracy is not checked easily, change the watch function (stopwatch mode, etc.). 	<p>Does not gain or lose: Normal Gain or loses: Defective Adjust the time accuracy by turning the trimmer condenser.</p>
CHECK SPEAKER BLOCK	<p>Check the speaker block for short circuit or broken wire.</p> <ol style="list-style-type: none"> Set up the Volt-ohm-meter. Range to be used: OHMS R \times 1 Checking 	<p>120Ω ~ 140Ω: Normal 120Ω or less (Short circuit): Defective. More than 140Ω (Broken wire): Defective Replace the speaker block.</p>

Procedure

Check the conductivity between switch component and circuits.
Check with the case bezel installed.

- 1) Confirm that the winding stem holder comes into contact with the circuit block when the button is released and does not come into contact when the button is released.
- 2) Confirm that the click is heard and the switch lever moves right and left when the crown is rotated.

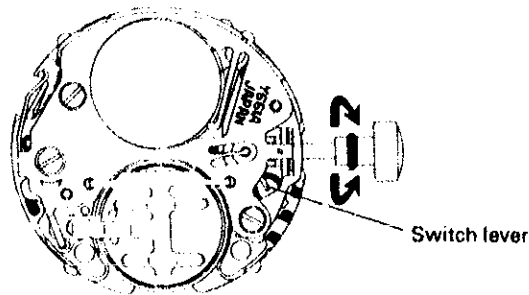

Result and repair

There is a clearance between switch component and circuit block: Normal
There is no clearance between switch component and circuit block: Defective
Replace the winding stem.
Clicks and the switch lever moves right and left: Normal
Does not click and the switch lever does not move right and left: Defective

[Y661]

Confirm that the display changes in the sequence of the arrow when the crown is rotated.

Confirm that the watch enters the reset mode from each mode when the crown is pulled and each mode can be reset when the crown is rotated.

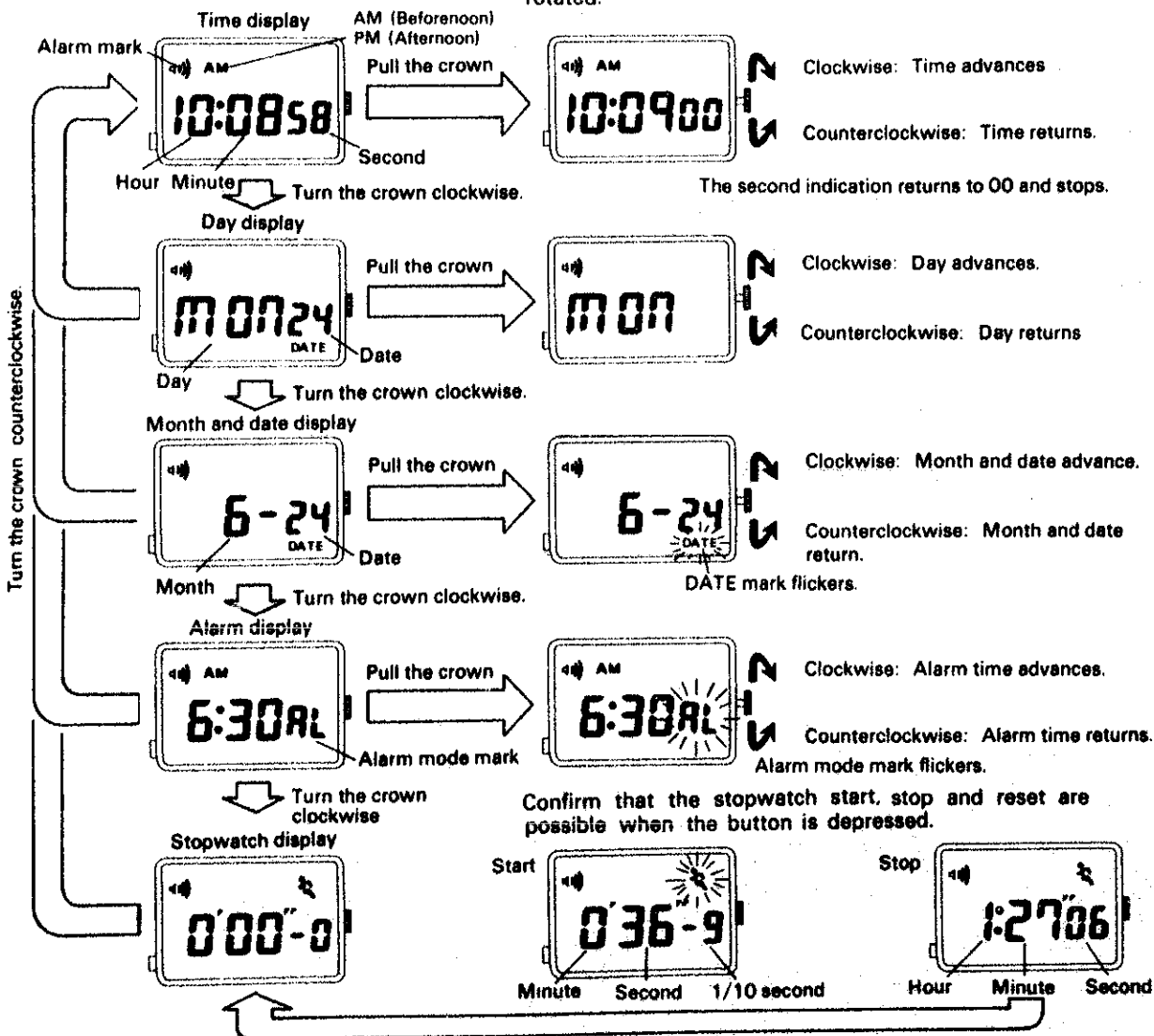

Procedure

[Y662]

Confirm that the display changes in the sequence of the arrow when the crown is rotated.

Confirm that the watch enters the reset mode from each mode when the crown is pulled and each mode can be reset when the crown is rotated.

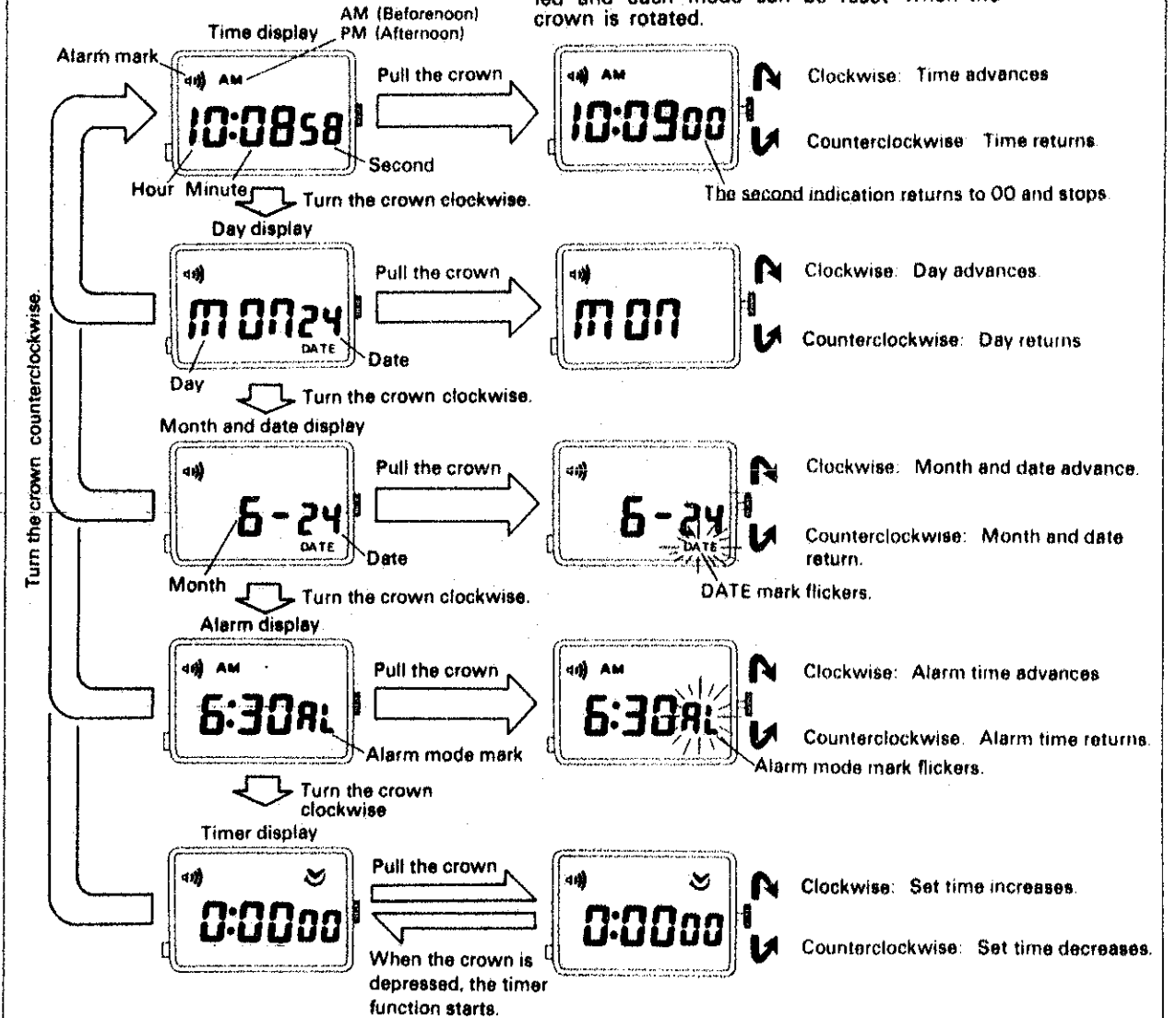

Countermeasure for all segment displayed condition

All segments sometimes displayed. At that time, open the case back and remove the battery. Short circuit the battery connection ⊖ and winding stem holder with tweezers.

PARTS LIST

CAL. Y661A & Y662A

Cal. Y661A		Cal. Y662A	
PART NO.	PART NAME	PART NO.	PART NAME
354 069	Winding stem	354 069	Winding stem
* 735 061	Winding stem holder	* 735 064	Winding stem holder
4001 204	Circuit block	4001 216	Circuit block
4238 001	Switch lever spring	4238 001	Switch lever spring
4246 015	Lead terminal ⊕	4246 015	Lead terminal ⊕
4247 008	Winding stem holder bush	4247 008	Winding stem holder bush
4256 008	Speaker block fixing spring	4256 008	Speaker block fixing spring
4313 036	Connector	4313 036	Connector
4398 213	Speaker frame	4398 213	Speaker frame
4450 010	Switch lever	4450 010	Switch lever
4510 036	Liquid crystal panel (Silver)	4510 066	Liquid crystal panel (Silver)
4510 037	Liquid crystal panel (Gold)	4510 067	Liquid crystal panel (Gold)
4580 062	Speaker block	4580 062	Speaker block
4991 152	Speaker gasket	4991 152	Speaker gasket
012 462	Winding stem holder screw	012 462	Winding stem holder screw
017 295	Tube for winding stem holder screw	017 295	Tube for winding stem holder screw
017 524	Switch lever pin	017 524	Switch lever pin
MAXELL SR721W	Silver oxide battery	MAXELL SR721W	Silver oxide battery

SEIZAIKEN TR721W

SEIZAIKEN TR721W

REMARKS:

*Winding stem holder for Pulsar Watches (Y661A)

735062 (Pulsar marking)

*Winding stem holder for Pulsar Watches (Y662A)

735065 (Pulsar marking)