

TECHNICAL GUIDE

CAL. Y48 Series

ANALOGUE QUARTZ

CONTENTS

I. SPECIFICATIONS	1
II. CIRCUIT BLOCK SCHEMATIC	2
III. DISASSEMBLING, REASSEMBLING AND LUBRICATING	3
Y480A, Y480B	3
Y481A, Y481B, Y482A	7
IV. CLEANING	11
V. CHECKING AND ADJUSTMENT	12
1. Guide table for checking and adjustment	12
2. Procedure for checking and adjustment	13
A. Check output signal	13
B. Check battery voltage	13
C. Check battery conductivity	13
D. Check circuit block conductivity	13
E. Check reset and train wheel setting condition	14
F. Check coil block	15
G. Check current consumption	15
H. Check accuracy	16
● Time adjustment	16
I. Time setting	17

I. SPECIFICATION

Item	Cal. No.	Y480A	Y480B	Y481A	Y481B	Y482A
Indication system		2 hands (hand moves at 30 sec intervals)	2 hands (hand moves at 30 sec intervals)	3 hands	3 hands	2 hands (hand moves at 1 sec intervals)
Additional mechanism	Hand stop device	-	-	○	○	○
	Automatic electronic-handsetting by crown (Turning the crown clockwise or counter-clockwise)	○	○	-	-	-
	Electronic reset switch	-	-	○	○	○
Loss/gain	Loss/gain at normal temperature range Monthly rate: Less than 20 seconds					
Size of panel frame	φ18.4 mm (6h - 12h: 18.4 mm, 3h - 9h: 15.3 mm)					
Casing diameter	φ17.8 mm					
Height (Including battery)	2.7 mm (2.8 mm)					
Regulation system	-					
Measuring gate	10-second					
Battery	Battery life is approximately 4 years for SEIZAIKEN TR621SW and 3 years for MAXELL SR621SW, TOSHIBA SR621SW or VARTA 531. Battery voltage: 1.55V		MAXELL SR621SW, TOSHIBA SR621SW, SEIZAIKEN TR621SW or VARTA531 Battery voltage: 1.55V Battery life: Approx. 2 years			
Jewels	2 Jewels					

○ Yes
- No

Difference between each caliber. (For details, refer to the parts list.)

Y480A, Y480B	The main plate, center wheel and pinion, hour wheel and circuit block differ.
Y481A, Y481B	The main plate, auxiliary plate, train wheel bridge, fourth wheel and pinion, center minute wheel, hour wheel and circuit block differ.
Y481A, Y482A	The fourth wheel and pinion, center minute wheel and circuit block differ.

II. CIRCUIT BLOCK SCHEMATIC

Y480A, Y480B

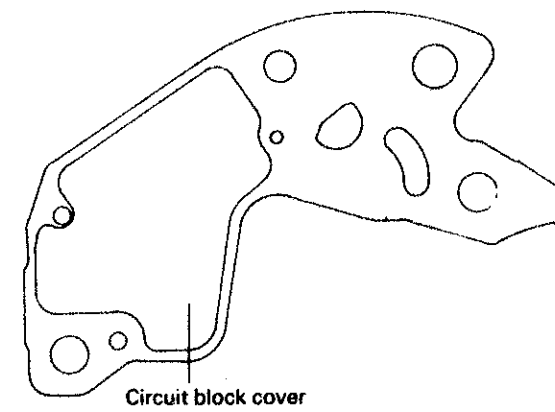

*The marking differs between Y480A and Y480B.

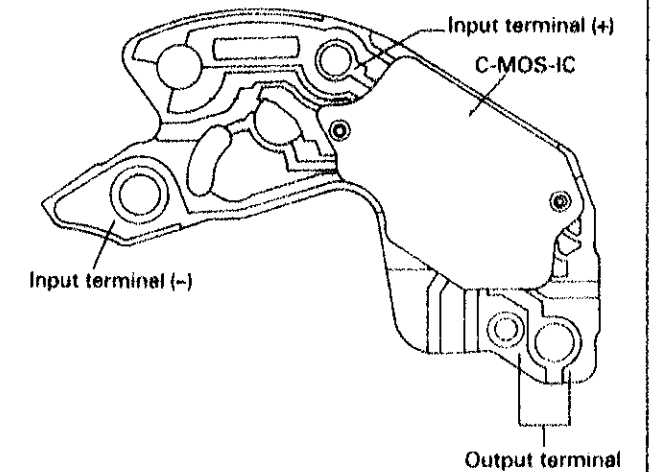

Y481A, Y481B, Y482A

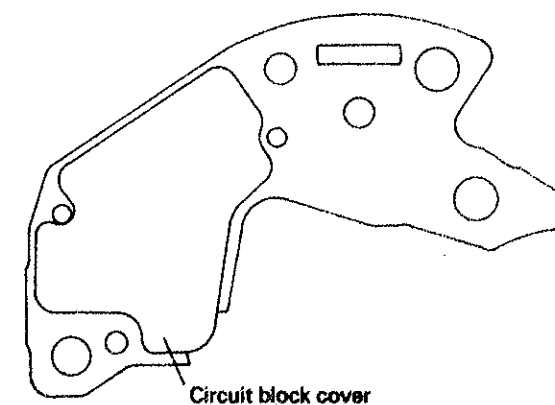

*The marking differs between Y481A, Y481B and Y482A.

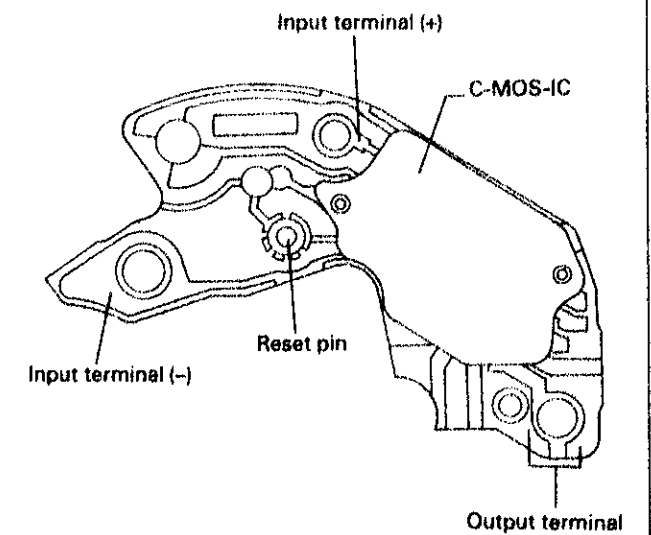

III. DISASSEMBLING, REASSEMBLING AND LUBRICATING (Y480A, Y480B)

Disassembling and reassembling

Disassembling procedures Figs. ① ~ ⑳
 Reassembling procedures Figs. ㉑ ~ ㉓

Lubricating

Types of oil Oil quantity
 ● Moebius A ● Liberal
 ○ Elgin oil ● Normal
 ● Extremely small

1. Indicating system

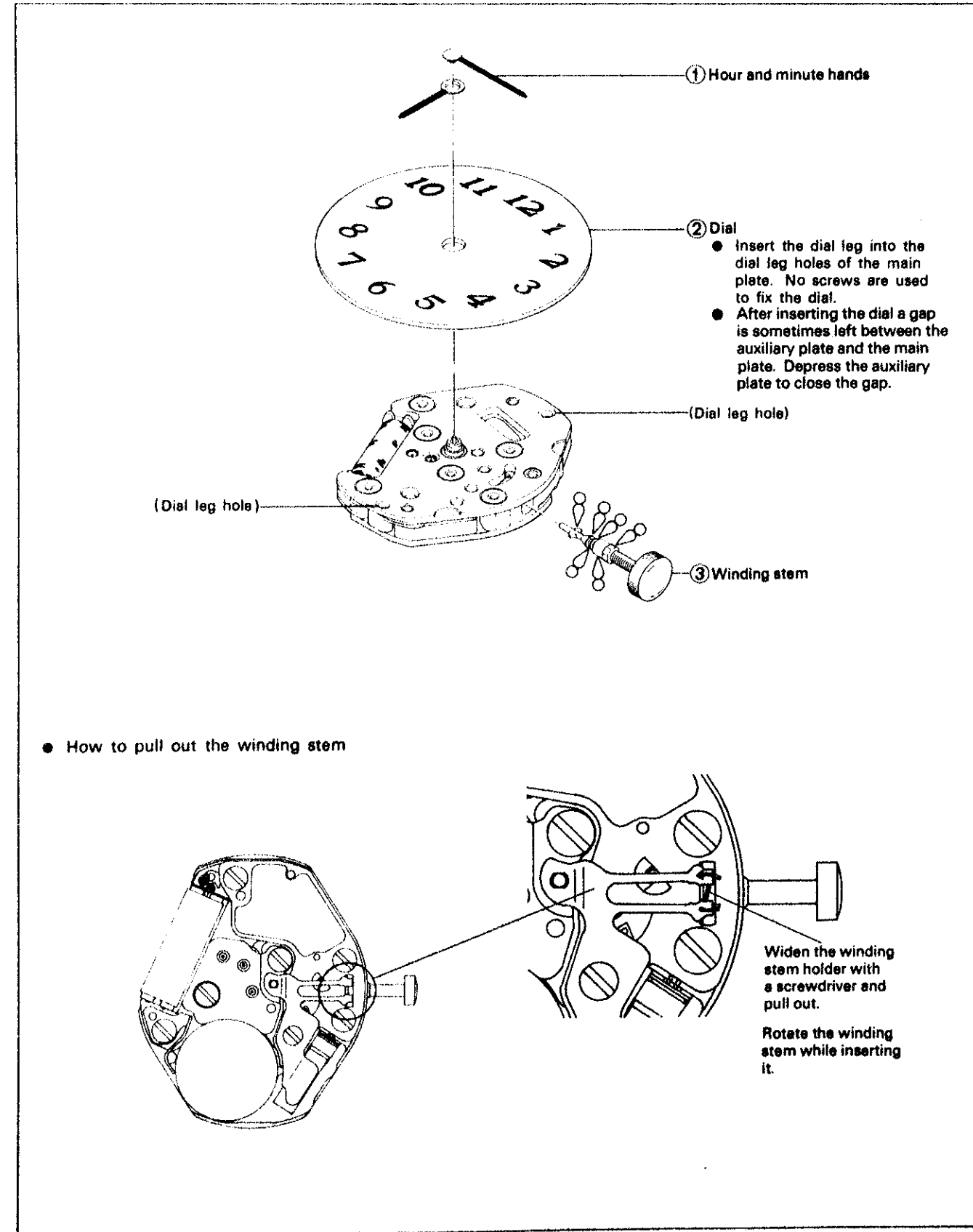

2. Electronic circuit

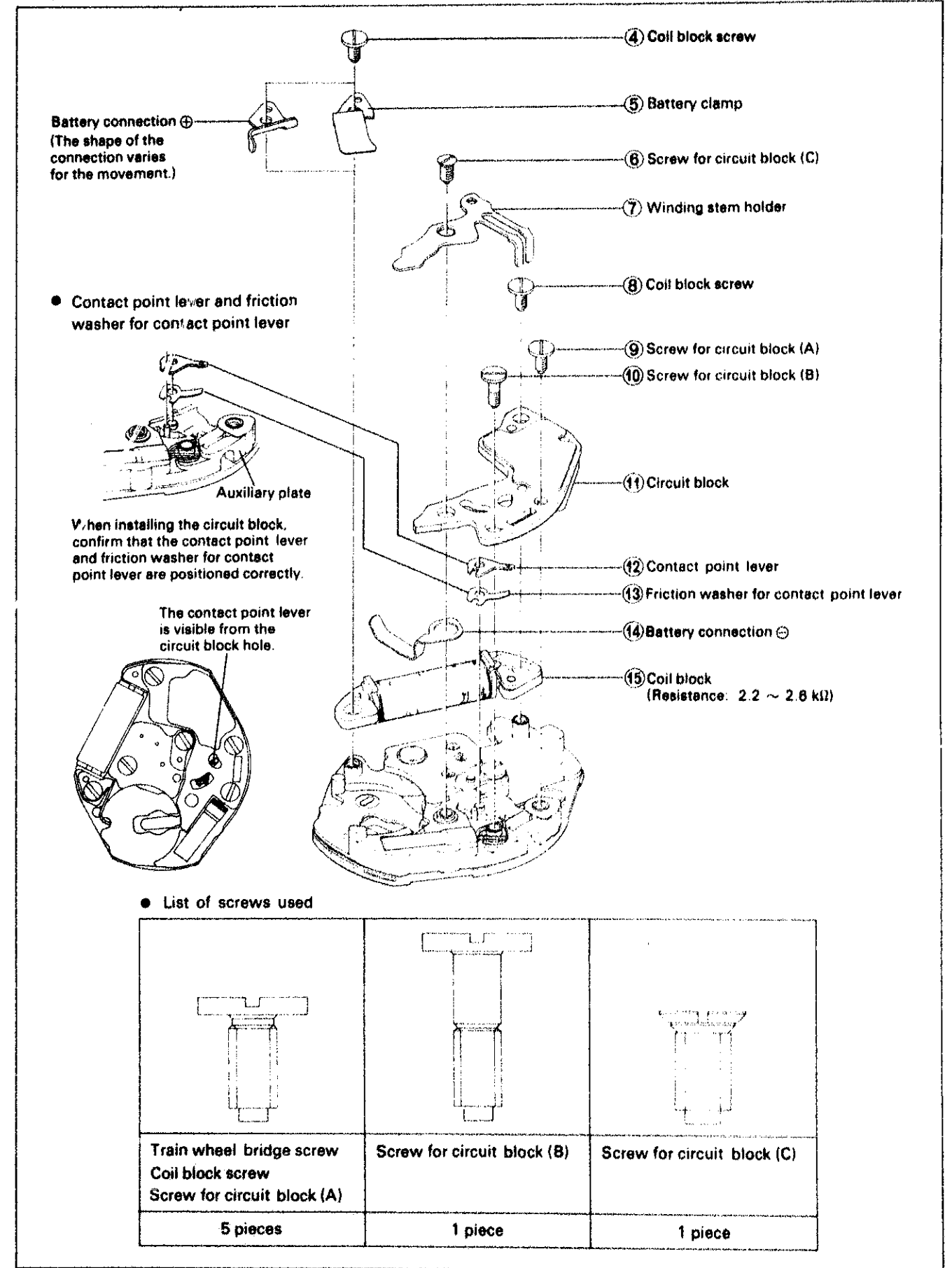

3. Gear train mechanism

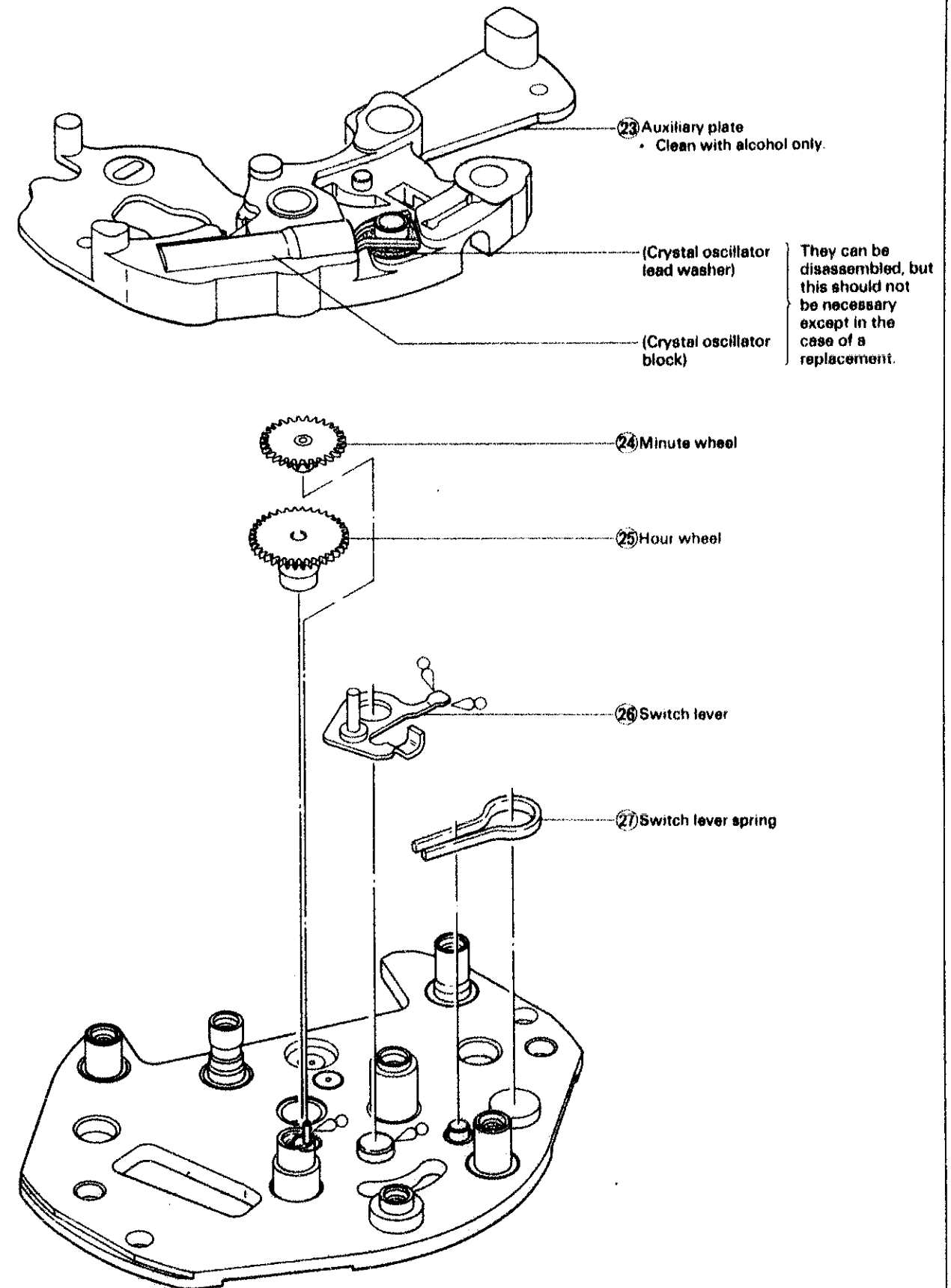
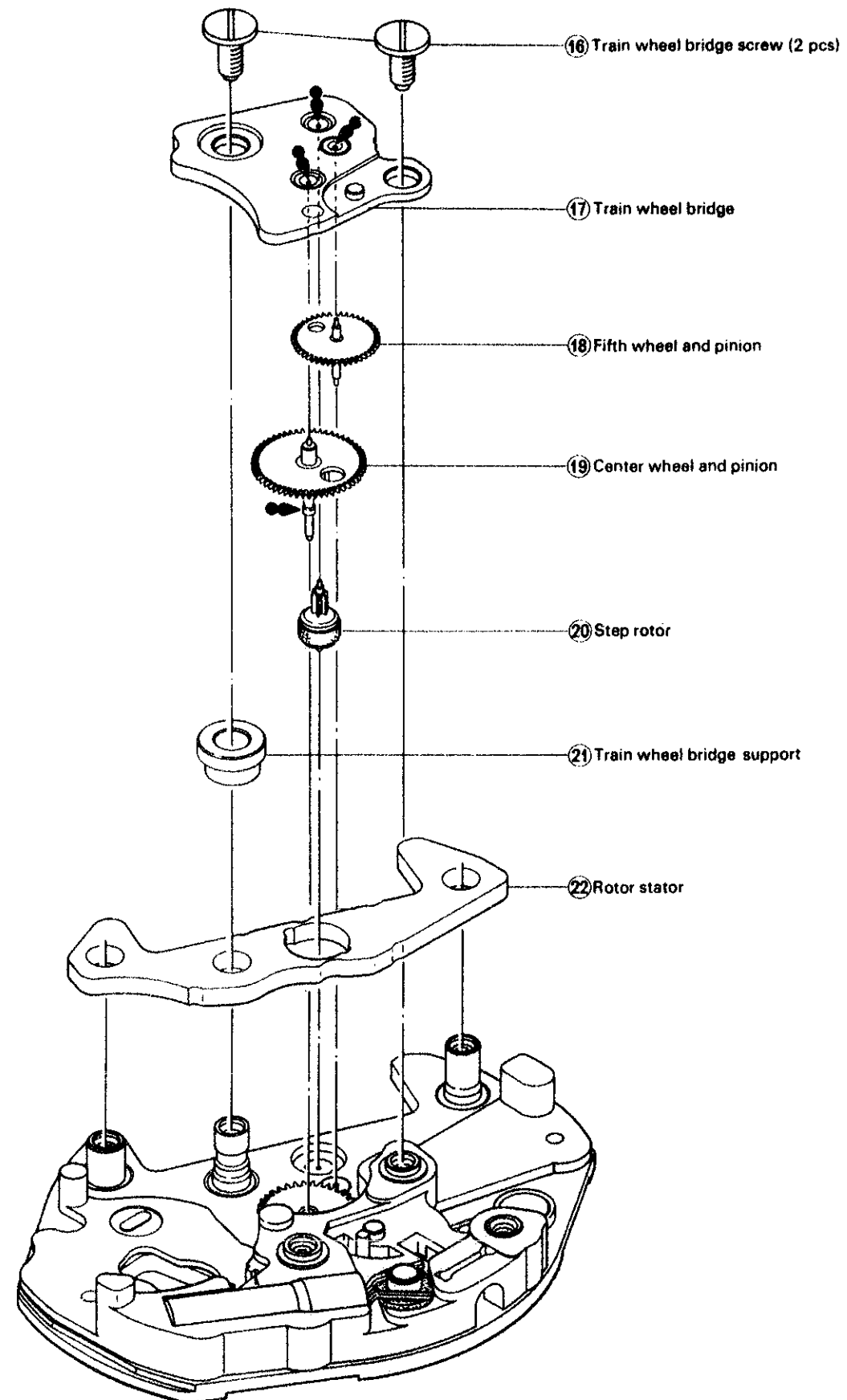

III. DISASSEMBLING, REASSEMBLING AND LUBRICATING (Y481A, Y481B, Y482A)

● The procedure is based on Y481A.

● Disassembling and reassembling

Disassembling procedures Figs. (1) ~ (30)
 Reassembling procedures Figs. (30) ~ (1)

● Lubricating

Types of oil Oil quantity
 ● Moebius A ● Liberal
 ○ Elgin oil ● Normal
 ● Extremely small

1. Indicating system

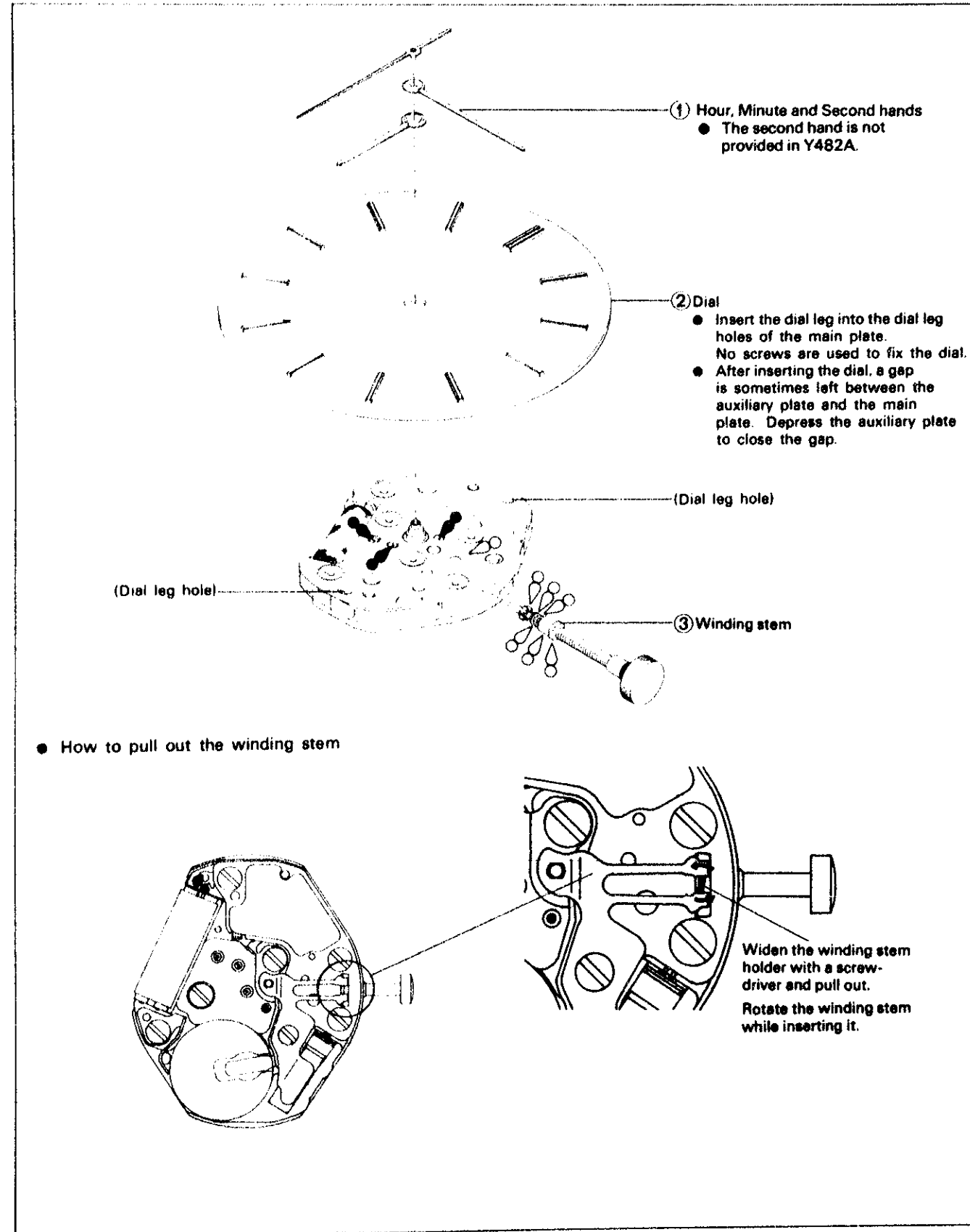

2. Electronic circuit

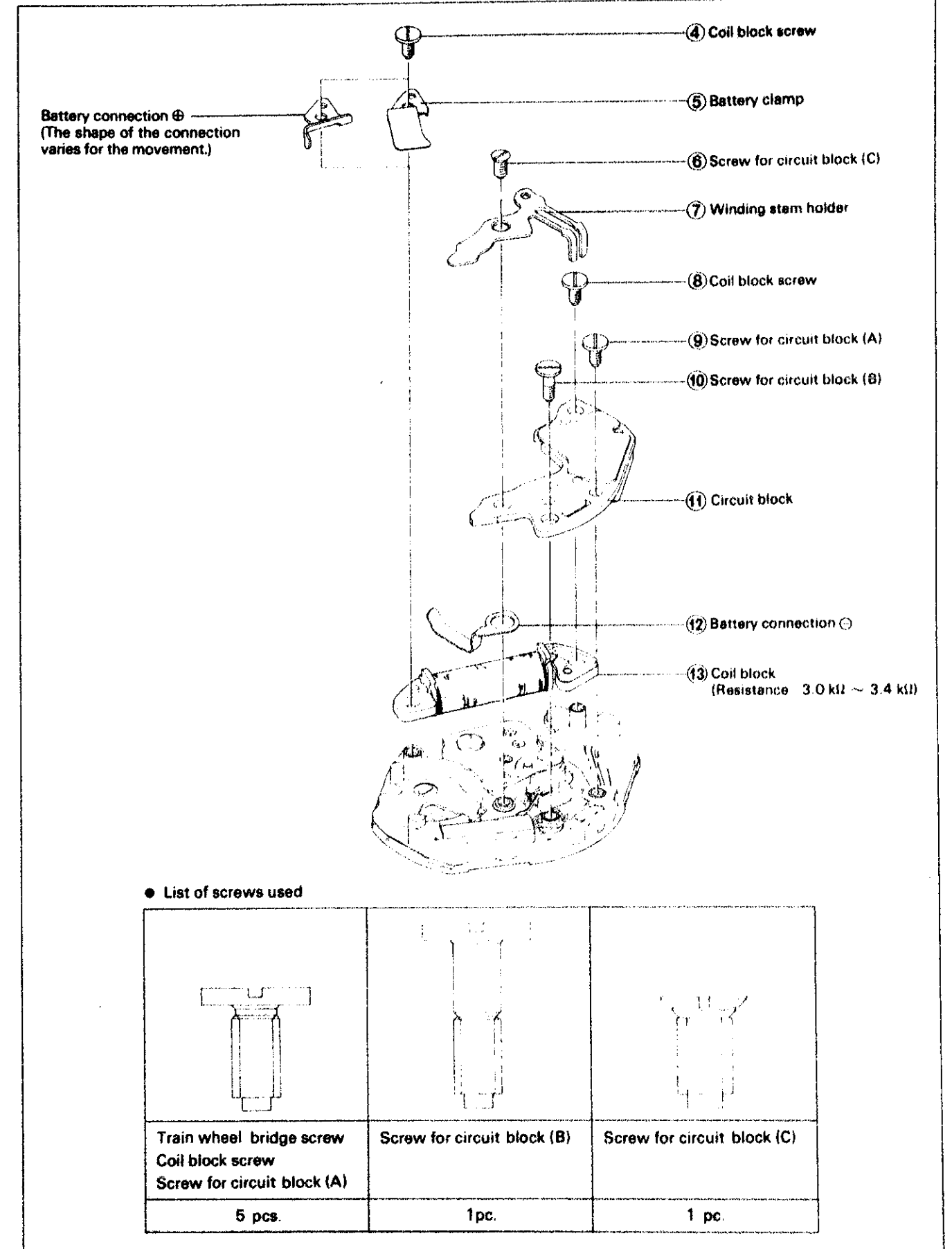

3. Gear train mechanism

Set position of train wheel setting lever, crystal oscillator block and reset lever

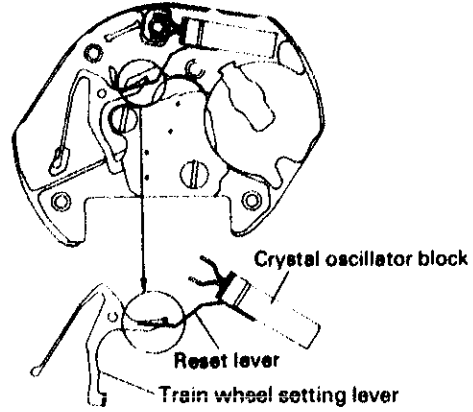

Set the train wheel setting lever and reset lever as shown in the above illustration.

• Set position of wheels

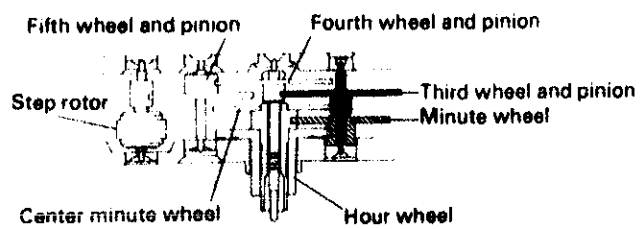
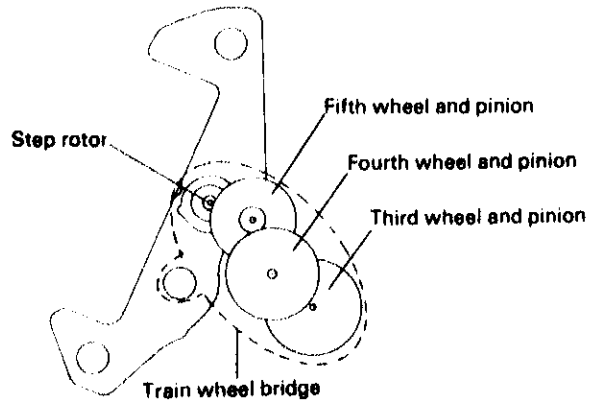

Set the third wheel and pinion in a minute wheel.

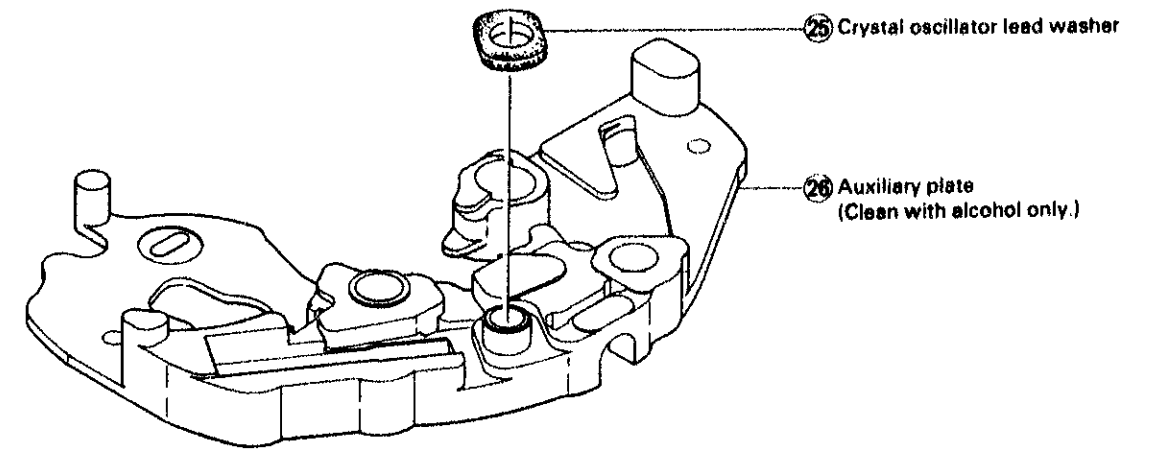
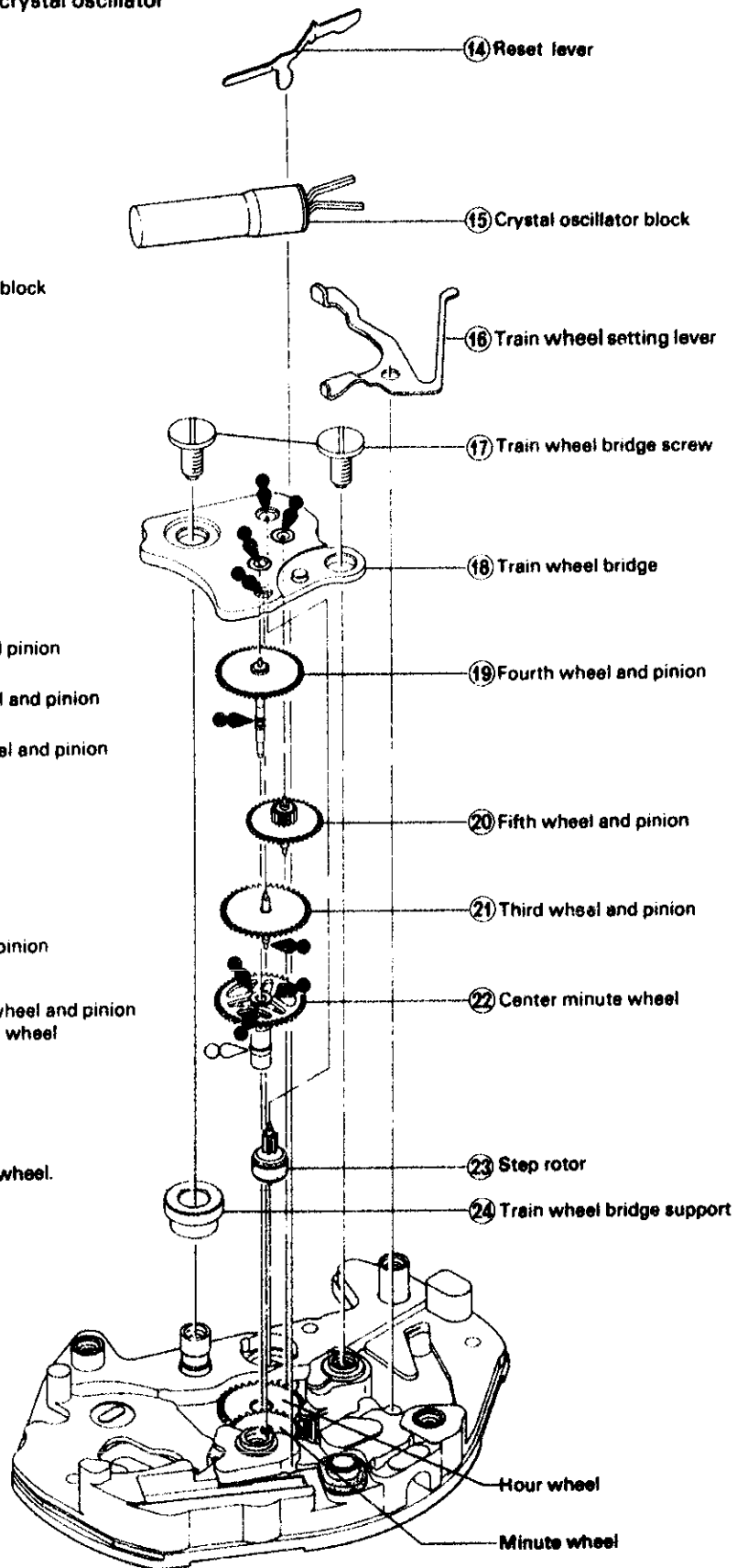

(Clean with alcohol only.)

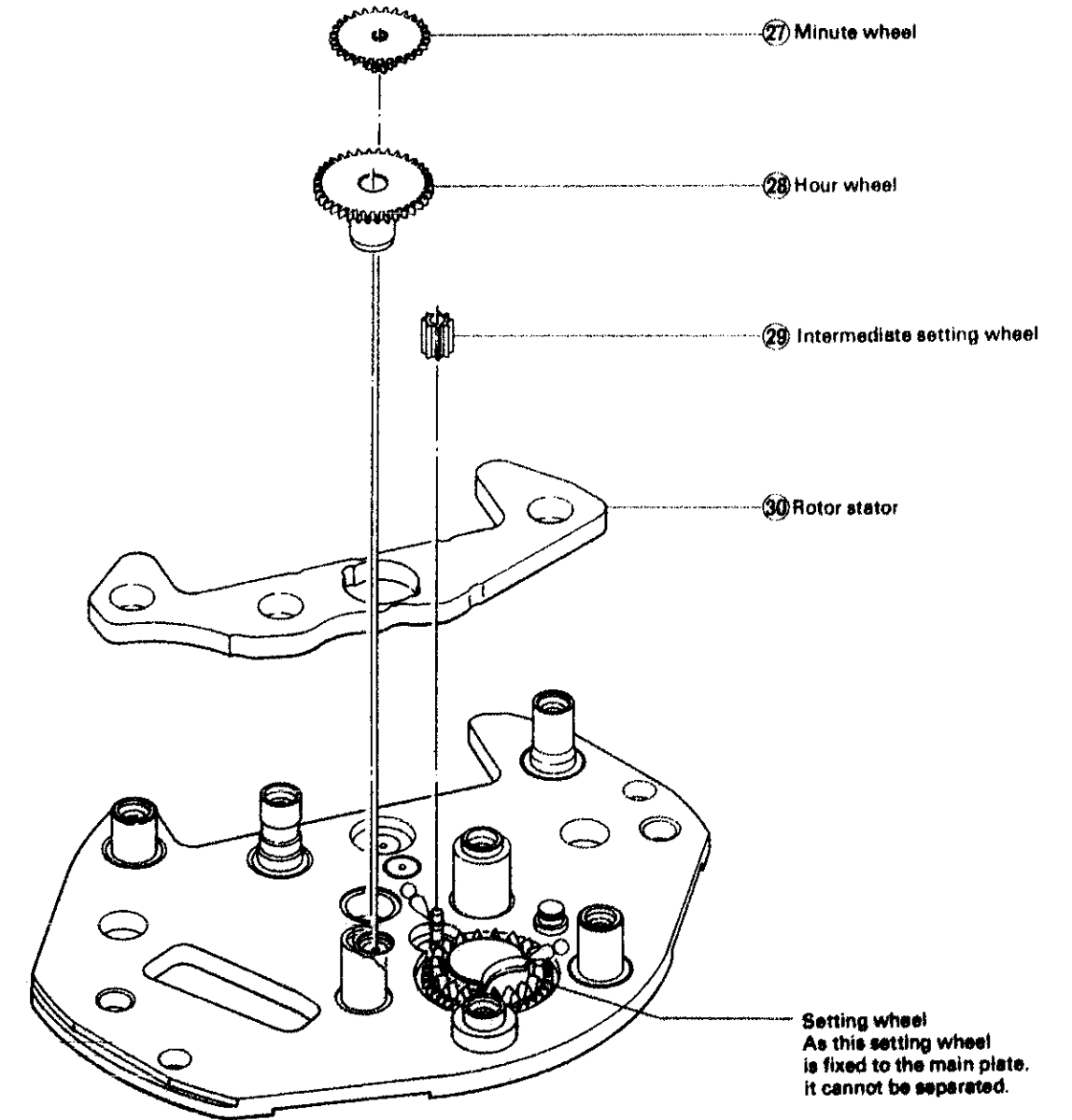



Setting wheel
As this setting wheel is fixed to the main plate, it cannot be separated.

IV. Cleaning

Use the following cleaning methods when cleaning.

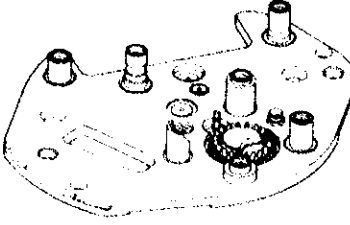
1) How to clean

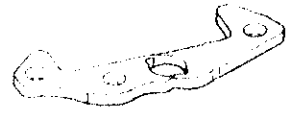
Name of parts	Cleaning	Drying	Solution	Remarks
Main plate 	Rinse or wash with a soft brush.	Warm air	Benzene	
Step rotor 				Use a clean solution as the step rotor is magnetized. Any foreign matter which cannot be removed by cleaning should be removed with rodico.
Rotor stator 				
Plastic parts (Auxiliary plate)	Rinse or wash with a soft brush	Warm air	Alcohol	
Others (excluding the parts that must not be cleaned)	Rinse and wash with a cleaner or wash with a soft brush	Warm or hot air	Benzene	

2) Parts that must not be cleaned.

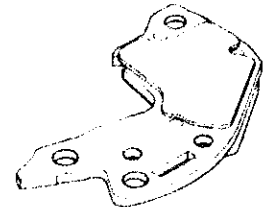

Circuit block

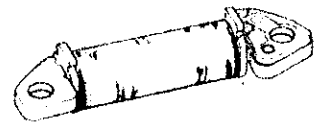

Coil block



Battery

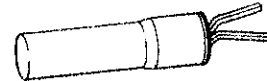

Crystal oscillator block

- Only the conductive portions should be wiped with a cloth moistened with benzene or alcohol and dried with warm air.

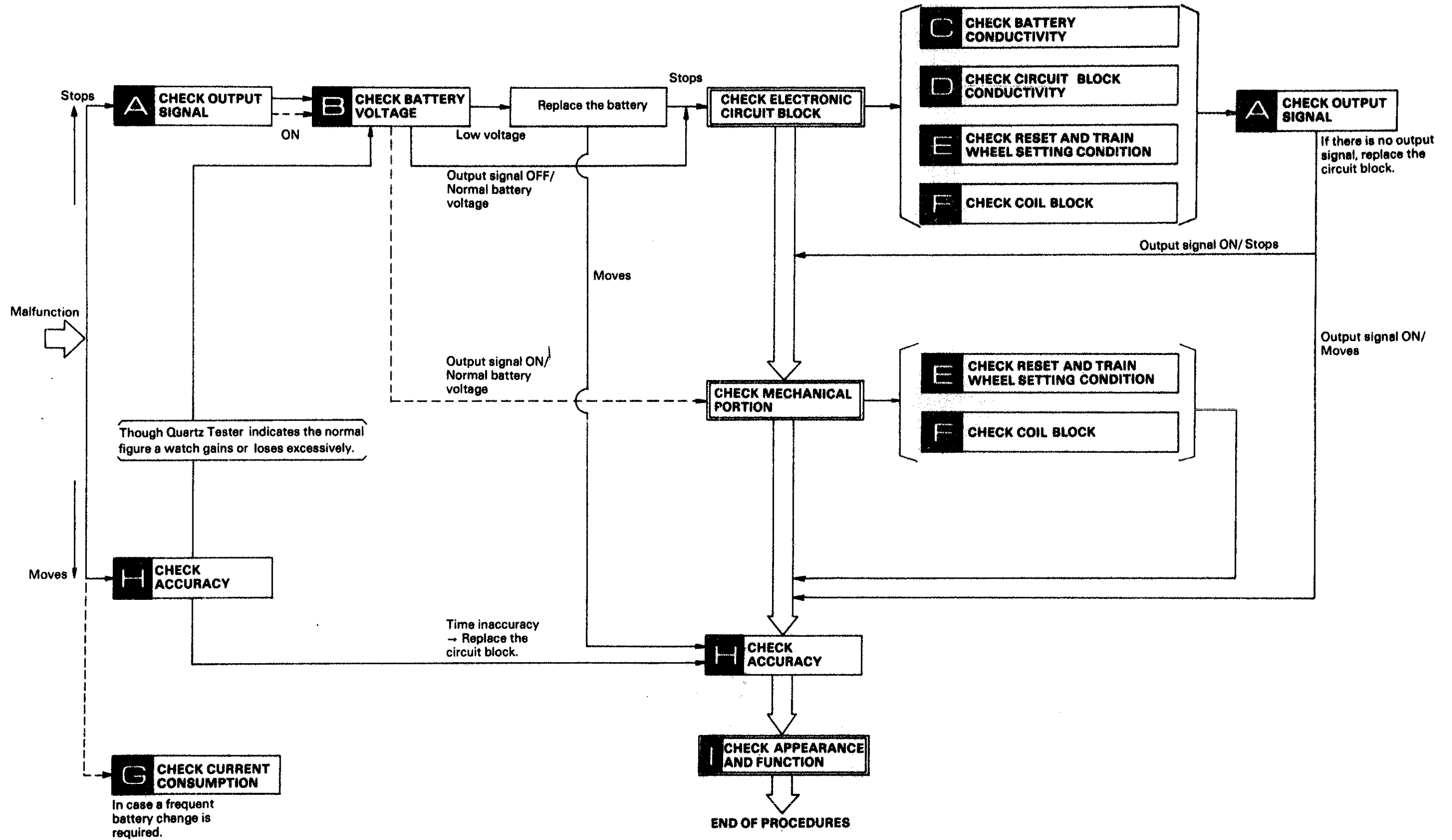

V. CHECKING AND ADJUSTMENT

1. Guide table for checking and adjustment

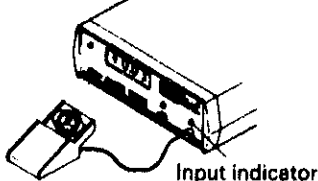
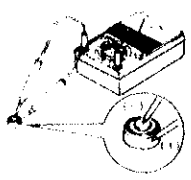

2. Procedure for checking and adjustment

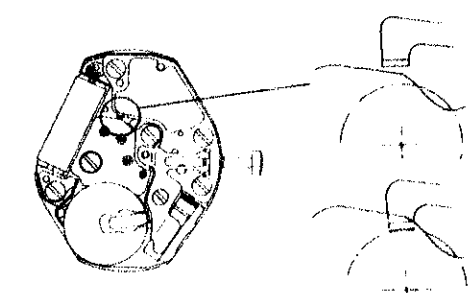
	Procedure	Result and repair
CHECK OUTPUT SIGNAL	<p>Check for output signal of the watch.</p> <ol style="list-style-type: none"> 1. Set up the Quartz Tester 2. Checking <p>Check for blinking input indicator light.</p>  <p style="text-align: center;">Input indicator</p>	<p>Y480 Flickers for 10 sec: Normal Not flickers: Defective</p> <p>Y481, Y482 Flickers for 1 sec: Normal Not flickers: Defective</p>
CHECK BATTERY VOLTAGE	<p>Check battery voltage</p> <p>Use the following procedures to check battery voltage</p> <ol style="list-style-type: none"> (1) Set up the Volt-ohm-meter. Range to be used: DC 3V (2) Measuring Probe Red (+): Battery surface (+) Probe Black (-): Battery surface (-) 	<p>1.5V or more: Normal Less than 1.5V: Defective Replace the battery with a new one.</p>
CHECK BATTERY CONDUCTIVITY	<p>Check battery conductivity</p> <ol style="list-style-type: none"> 1. Make sure that the circuit block screws are tightened firmly. 2. Check for any contamination on the connecting portion of battery, battery clamp and battery connection ⊖. 	<p>No loosened screws: Normal Proceed to 2</p> <p>Loosened screws: Defective Retighten the screws.</p> <p>Uncontaminated: Normal Proceed to 2</p> <p>Contaminated: Defective Wipe off carefully.</p>
CHECK CIRCUIT BLOCK CONDUCTIVITY	<p>Check circuit block conductivity</p> <ol style="list-style-type: none"> 1. Check to see if the screws for circuit block (A), (B) and (C) are tightened firmly. 2. Check the electrodes between the crystal oscillator block and circuit block, and the circuit block for any break in the welded portion, short circuit, pattern break and contamination. 	<p>No loosened screws: Normal Proceed to 2</p> <p>Loosened screws: Defective Retighten the screws.</p> <p>No break in the welded portion, short circuit, pattern break or contamination: Normal Proceed to 2</p> <p>Break in the welded portion, short circuit or pattern break: Defective Replace the circuit block.</p> <p>Contaminated: Defective Wipe off carefully.</p>

	Procedure	Result and repair
CHECK RESET AND TRAIN WHEEL SETTING CONDITION	<p>Y481, Y482</p> <ul style="list-style-type: none"> ● Check reset and train wheel setting condition: Check with the either following two procedures. <ol style="list-style-type: none"> 1. Check that the second hand stops immediately after the crown is pulled out and it starts promptly after on second when the crown is pushed in to the normal position. 2. Check with an output signal from a Quartz tester when the watch has been reassembled. <ol style="list-style-type: none"> (1) Check when the crown is in the normal position. (2) Check when the crown is pulled out 1 click. <ul style="list-style-type: none"> ● Check train wheel setting lever position: <ol style="list-style-type: none"> 1. With the crown at the normal position  <ol style="list-style-type: none"> 2. With the crown at the first click position  	<p>Stops completely and starts after one second: Normal Does not stop or moves irregularly: Defective</p> <p>Flickers for 1 sec: Normal Not flicker: Defective (Replace reset lever.)</p> <p>Flickers for 1 sec: Normal Not flicker: Defective (Replace the reset lever.)</p> <p>The train wheel setting lever is in the outside of train wheel bridge: Normal The train wheel setting lever is in the inside of train wheel bridge and regulates the fifth wheel and pinion: Defective (Replace the train wheel setting lever.)</p> <p>The train wheel setting lever is in the inside of train wheel bridge and regulates the fifth wheel and pinion: Normal The train wheel setting lever is in the outside of the train wheel bridge: Defective (Replace the train wheel setting lever.)</p>

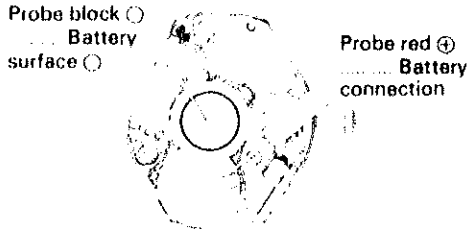
	Procedure	Result and repair
CHECK COIL BLOCK	<p>Check coil block</p> <ol style="list-style-type: none"> 1. Set up the Volt-ohm-meter. Range to be used: OHMS R x 100 2. Measuring Apply the two probes of the Volt-ohm-meter to the two lead terminals of the coil block as shown in the illustration. 	<p>Y480 2.2 kΩ ~ 2.6 kΩ: Normal Less than 2.2 kΩ (short circuit): Defective More than 2.6 kΩ (Broken wire): Defective (Replace the coil block.)</p> <p>Y481, Y482 3.0 kΩ ~ 3.4 kΩ: Normal Less than 3.0 kΩ (Short circuit): Defective More than 3.4 kΩ (Broken wire): Defective (Replace the coil block.)</p>
CHECK CURRENT CONSUMPTION	<p>Check current consumption</p>  <p>Y480</p> <ul style="list-style-type: none"> ● As this watch employs 30 sec hand movement system, the pointer of Volt-ohm-meter moves every 30 seconds during current consumption measurement. ● When the probes of the Volt-ohm-meter are connected to the movement, the pointer moves slightly to indicate that a current is supplied to the IC. After 30 seconds, the pointer moves to indicate that the motor drive current flows, as well as the IC current. ● Calculate the current consumption as follows. Where, IC current = 0.5 μA IC current + Motor drive current = 2.6 μA The current required for driving motor is 2.1 μA. This current consumption is in 30 sec hand movement. And, the value should be converted into that in 1 sec hand movement. When the current of 2.1 μA is divided by 30, the current consumption of the motor is 0.07 μA. Therefore, the current consumption of this watch is; 0.5 μA + 0.07 μA = 0.57 μA 	<p>Y48 series Less than 0.9 μA: Normal 0.9 μA or more: Defective (Check the electronic circuit.)</p>

	Procedure	Result and repair
CHECK ACCURACY	<p>Check accuracy</p> <ol style="list-style-type: none"> 1. Set up the Quartz tester. 2. Measuring <ul style="list-style-type: none"> ● For measuring Y48 series accuracy, always use the 10-second gate of Quartz tester. ● The Y480 employs 30 sec hand movement. However, hand movement pulse is output every 10 seconds. To measure the accuracy, use the 10-second gate of Quartz tester. ● Ultrasonic microphone cannot be used. If it is used, the indication is other than accuracy of the watch. 	
TIME ADJUSTMENT	<p>Time adjustment</p>	<ul style="list-style-type: none"> ● The Y48 series employs the variable dividing system which changes the dividing ratio according to the oscillation of crystal. The accuracy is obtained by adjusting both the crystal block and circuit block. ● The trimmer condenser is not used. If the watch losses/gains excessively, replace the circuit block (with crystal block).

Procedure

Y480

Instructions for setting the time on Cal. Y480 quartz timepiece with electronic setting

This quartz timepiece contains an electronic time setting device which electronically turns the hands to set the correct time. With this new technology, you set the time by turning the crown in a series of small clicks rather than the conventional method of a free turning crown to turn the hands.

Once the correct time is set, quartz precision accuracy requires only rare fractional time adjustments. The normal exception is when hourly time adjustments are made when changing from standard time to daylight savings time and back, and when travelling from one time zone to another. This electronic setting device was developed to take care of these adjustments with maximum precision.

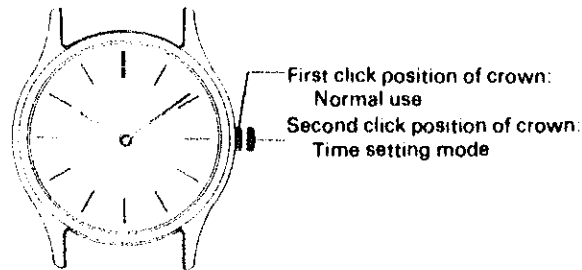

How to set the time

By following the instructions below the correct time can be set. Pull the crown out into the time setting position as with any ordinary timepiece.

Setting the hours – Turning the crown 2 clicks in rapid succession (within 1/2 second) will rotate the hands exactly one hour. The hands will rotate forward or backwards depending on the direction the crown is turned. To advance the hands, turn the crown clockwise (away from you). To move the hands backwards, turn the crown counterclockwise (towards you). Keep repeating the procedure until the correct hour is reached.

Setting any portion of the hour – The hands can be stopped at any point of its hourly rotation cycle by tuning the crown one (1) click in either direction. Stop the hands when the minute hand reaches the correct time. If the hands are stopped within a few minutes of the correct time, follow the procedure below for setting the minutes to arrive at the exact time.

Setting the minutes – Turn the crown a single click and the minute hand will either advance or move backwards 30 seconds depending upon the direction the crown is turned. Repeat the procedure until the exact time is set. Push the crown in when time adjustments have been completed.

Y481, Y482

Check that the time can be set correctly.

Result and repair

All procedures of Disassembling, Reassembling, Checking and Adjustment are completed.

IV. PARTS LIST

Cal. Y480A			
PART NO.	PART NAME	PART NO.	PART NAME
102 480	Auxiliary plate	4408 021	Friction washer for contact point lever
125 480	Train wheel bridge	4408 022	Crystal oscillator lead washer
☆ 221 480	Center wheel and pinion (3.70 mm)	4450 480	Switch lever
☆ 221 481	Center wheel and pinion (3.90 mm)	011 541	Upper hole jewel for step rotor
261 480	Minute wheel	011 541	Lower hole jewel for step rotor
☆ 271 430	Hour wheel (1.71 mm)	012 168	Train wheel bridge screw
☆ 271 481	Hour wheel (1.91 mm)	012 168	Coil block screw
☆ 351 480	Winding stem (10.13 mm)	012 168	Screw for circuit block (A)
☆ 351 482	Winding stem (13.95 mm)	012 169	Screw for circuit block (B)
426 480	Train wheel bridge support	012 169	Screw for circuit block (C)
701 480	Fifth wheel and pinion	012 785	Screw for circuit block (C)
735 480	Winding stem holder	017 199	Tube for coil block screw (A)
4001 478	Circuit block	017 200	Tube for coil block screw (B)
4002 480	Coil block	017 201	Tube for circuit block
4146 480	Step rotor	017 202	Tube for circuit block screw (A)
4225 480	Holding spring for battery	017 203	Tube for train wheel bridge (A)
4238 480	Switch lever spring	017 206	Tube for train wheel bridge (B)
4239 480	Rotor stator	017 334	Tube for circuit block screw (B)
4270 480	Battery connection ⊖	☆ TR621SW	Silver oxide battery
4271 480	Battery connection ⊕	☆ Maxell SR621SW	
4282 480	Contact point lever		

Remarks:

Center wheel and pinion, Hour wheel.
There are two different types as specified below.

Combination:

Type	Center wheel and pinion	Hour wheel
a	 ☆ 221 480	 Silver ☆ 271 480
b	 ☆ 221 481	 Silver ☆ 271 481

Winding stem

- ☆ 351 480..... Short winding stem (10.13 mm, Threaded)
- ☆ 351 482..... Long winding stem (13.95 mm, Threaded)
- ☆ 351 483..... Short winding stem (13.00 mm, Unthreaded)
- ☆ 351 485..... Long winding stem (14.37 mm, Unthreaded)

Battery

- ☆ TR621SW
 - ☆ Maxell SR621SW
- The applied battery for this calibre might be added the substitutive in the future.

☆ ⊖ Please see remarks.