

TECHNICAL GUIDE AND PARTS LIST

CAL. V247A
CAL. V248A

ANALOGUE QUARTZ

CONTENTS

I. SPECIFICATIONS	1
II. DISASSEMBLING, REASSEMBLING AND LUBRICATING	2
III. CHECKING AND ADJUSTMENT	6
1. Structure of circuit block.....	6
2. Procedure for checking and adjustment.....	6
IV. PARTS LIST.....	9

I. SPECIFICATIONS

Cal. No.		V247A	V248A
Item			
Indication system		Three hands	
Additional mechanism	Date	○	○
	Day	-	○
	Date quick resetting device	○	○
	Day quick resetting device	-	○
	Second setting device	○	○
	Electronic reset switch	○	○
Loss/gain		Monthly rate: Less than 20 seconds at normal temperature range	
Movement size	Size of main plate	φ18.4 mm (6H - 12H 18.4 mm, 3H - 9H 15.3 mm)	
	Casing diameter	φ18.1 mm	
	Height (including battery)	2.7 mm	3.1 mm
Regulation system		-	
Measuring gate		10-second gate	
Battery		SEIZAIKEN TR621SW or MAXELL SR621SW Voltage: 1.55V Battery life: TR621SW..... approx. 2 years SR621SW..... approx. 1.5 years	
Jewels		2 jewels	

○..... Yes
-..... No

II. DISASSEMBLING, REASSEMBLING AND LUBRICATING

Disassembling procedures: Figs ① ~ ④
Reassembling procedures: Figs ④ ~ ①

Lubricating

Types of oil	Oil quantity
Moebius A	Small \sphericalangle
Seiko watch oil S-6	Standard \sphericalangle
	Large \sphericalangle

● Hands ~ Holding ring for dial

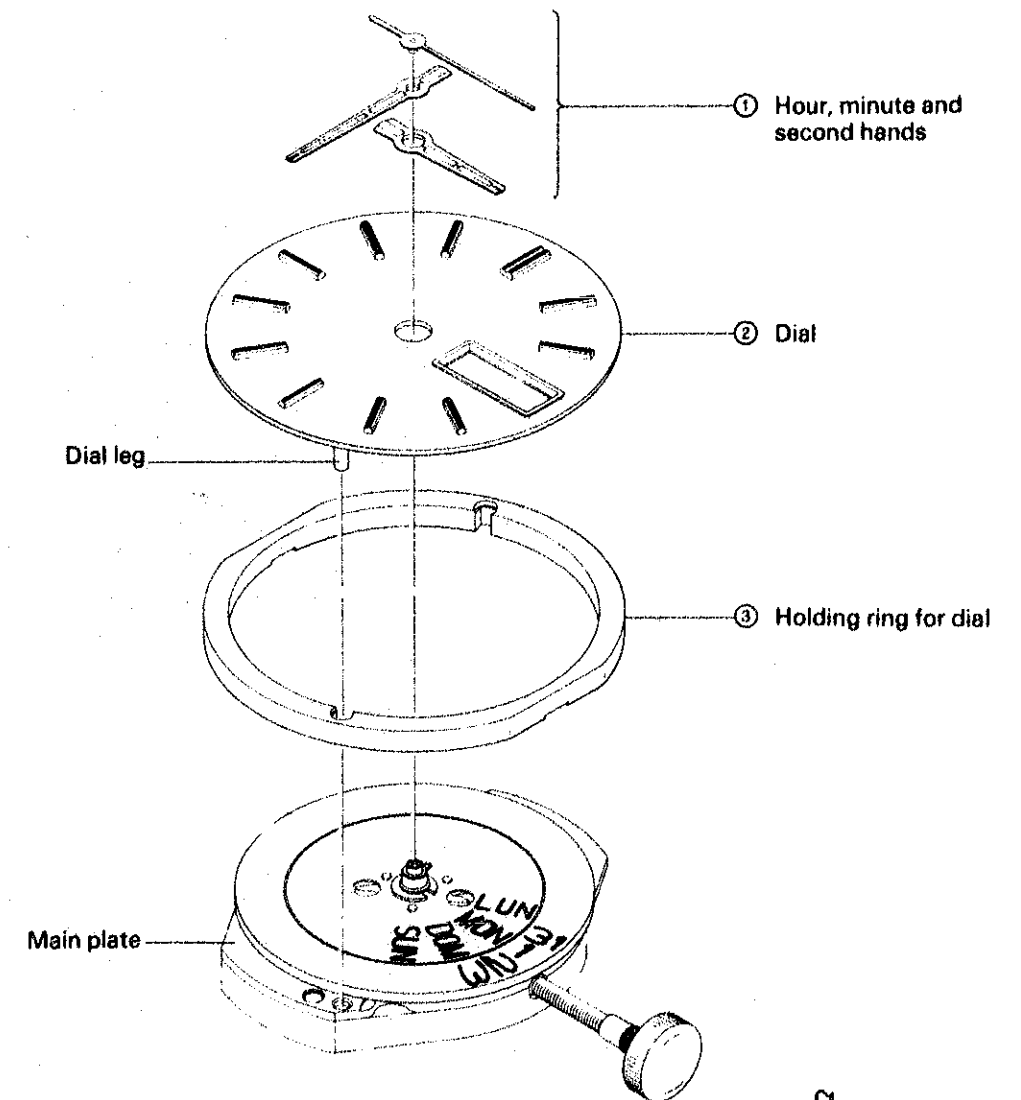

② Dial

In some models, dial leg holders are used to fix the dial. To remove the dial, shift the dial leg holders in the directions of arrows.

When the dial leg holders are not used, insert a screwdriver between the holding ring for dial and main plate and pry out the dial.

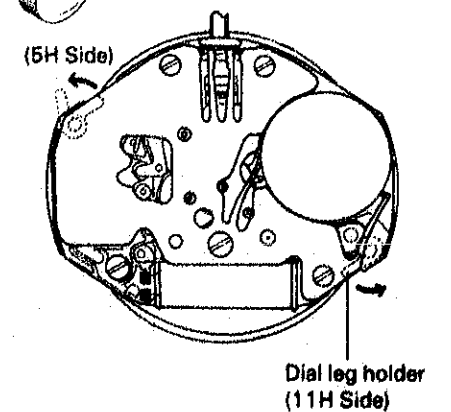

● Battery ~ Winding stem holder support

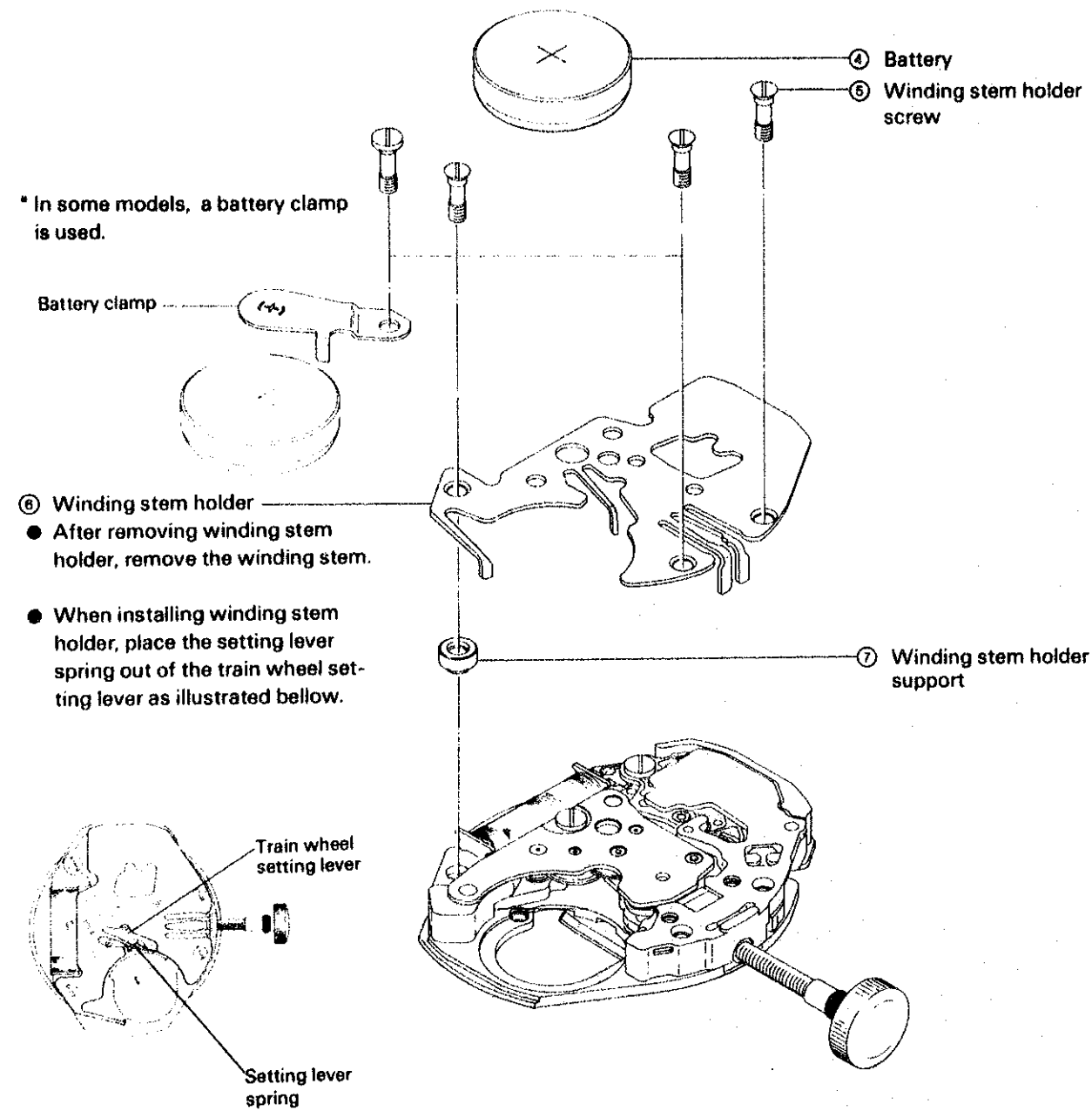

● Snap for day star with dial disk ~ Date driving wheel

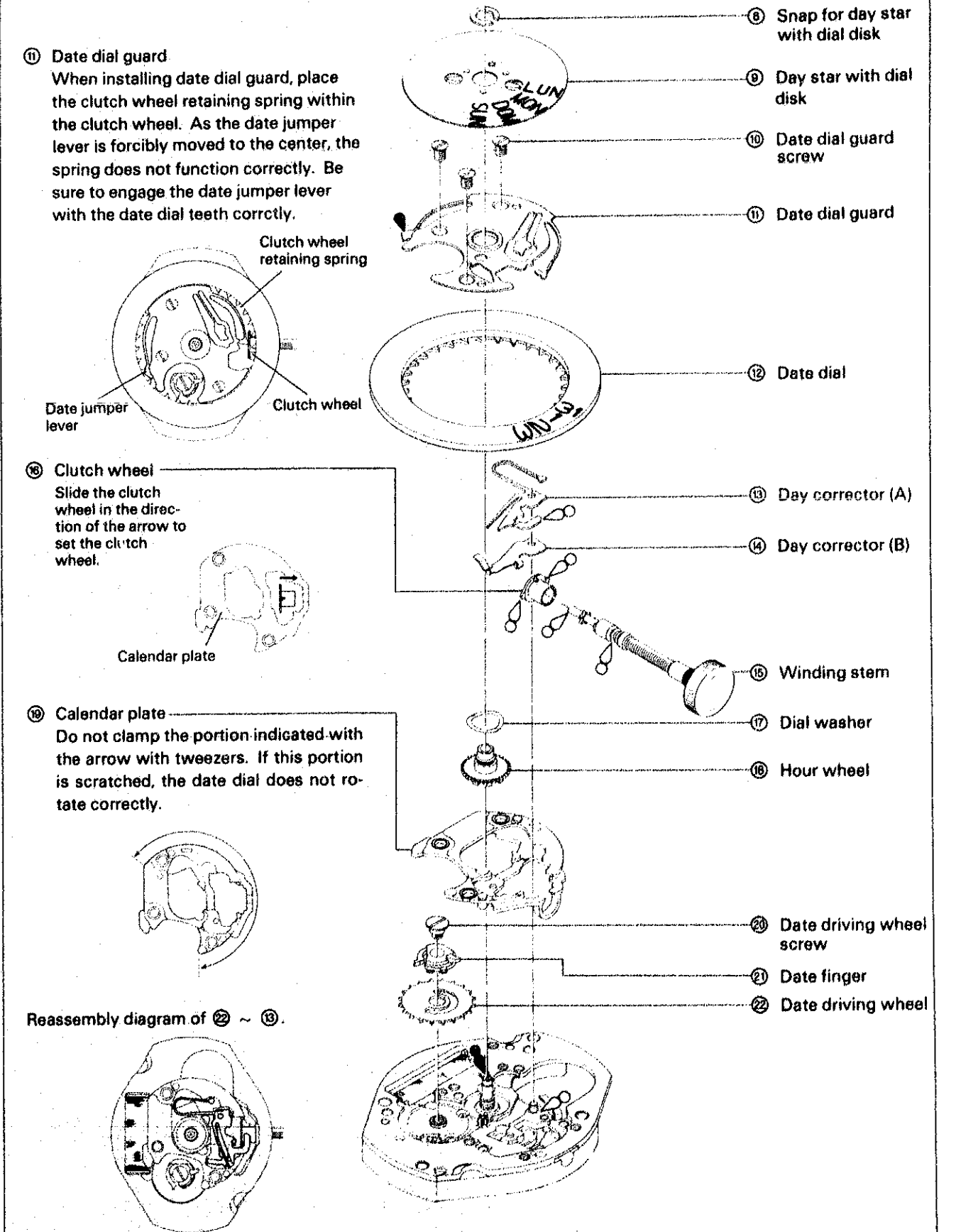

● Train wheel bridge screw ~ Main plate

Reassembly diagram of wheels (cross sectional view)

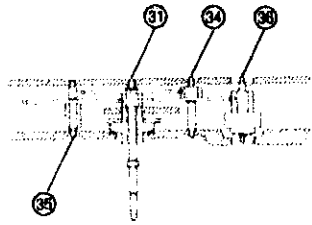

Reassembly diagram of 42 ~ 20

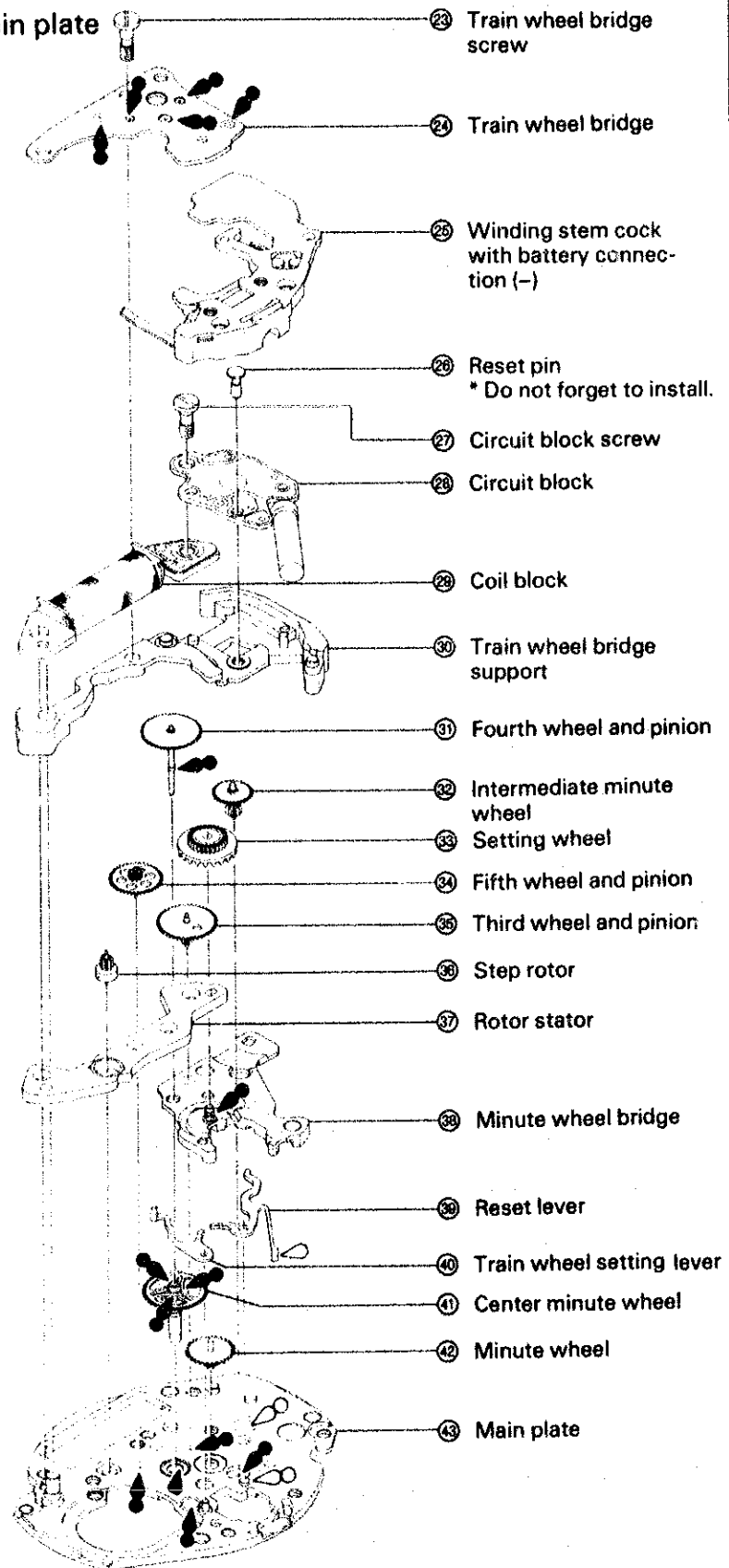
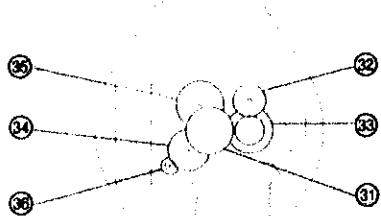

III. CHECKING AND ADJUSTMENT

1. Structure of circuit block

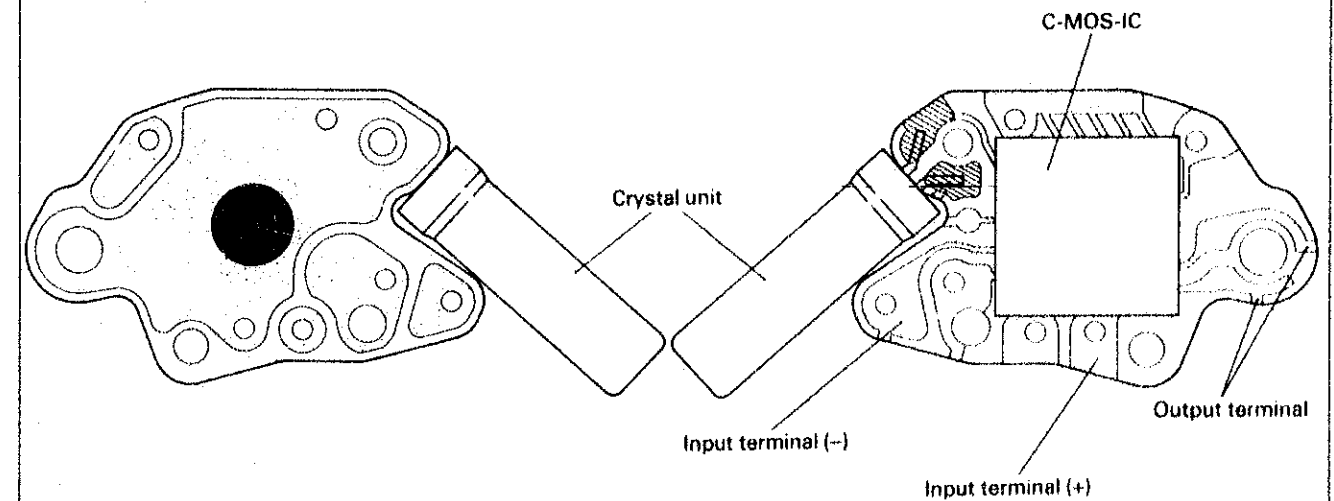

2. Procedure for checking and adjustment

- This section only gives the checking and adjustment procedure which is exclusive for this watch.
- For the normal checking and adjustment, refer to the "TECHNICAL GUIDE GENERAL INSTRUCTION, Analogue Quartz".
- The page numbers in the item correspond to those in the "TECHNICAL GUIDE GENERAL INSTRUCTION, Analogue Quartz".

CHECK OUTPUT SIGNAL p.6

Result:
Output signal: Normal
No output signal: Defective

BATTERY VOLTAGE p.7

Use the Digital Multi Tester S-840A.
Range to be used: DC V

Result:
1.5V or more: Normal
Less than 1.5V: Defective
Replace the battery.

NOTE:

Before measuring, short circuit the probes and confirm that the tester reads AUTO 00.0 mV or AUTO 00.1 mV.

BATTERY CONDUCTIVITY p.9

Check that the battery voltage is correctly applied to the circuit.

CIRCUIT BLOCK CONDUCTIVITY p.9

Check for short circuit and defective conductivity of the conductive portions of the circuit block.

COIL BLOCK p.10

Check the coil block for broken wire and short circuit.
Use the Digital Multi Tester S-840 A.
Range to be used: Ω

NOTE:

- Before measuring, short circuit the probes and check to see if the tester sounds and reads from AUTO 00.2 Ω to AUTO 00.4 Ω . The actual resistance can be obtained by subtracting the initial value (00.2 - 00.4) from the measured value.
- When measuring, take care not to break the coil block leads.

Result:
2.4 ~ 2.8 k Ω : Normal
Less than 2.4 k Ω (Short circuit):
More than 2.8 k Ω (Broken wire):
Defective
Replace the coil block.

FRONT GEAR TRAIN MECHANISM p.11

Check the front gear train mechanism for play of rotor and wheels and pinions, mis-installation, dust, lint, foreign matter, lubrication, etc.

BACK GEAR TRAIN MECHANISM p.11

Check the back gear train mechanism for lubrication leakage, play, dust, lint, etc.

RESET CONDITION

With the movement installed, check that the reset condition is normal.

1. Check the clearance between the train wheel setting lever and fourth wheel and pinion.

(1) Check the clearance with the crown at normal position.

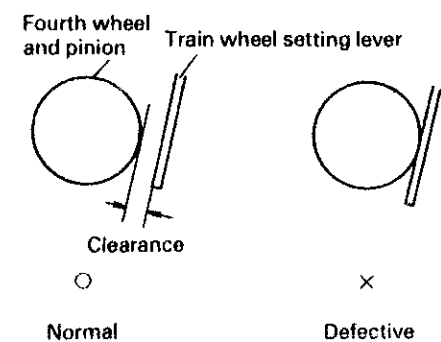

Result:
Clearance: Normal
No clearance: Defective
Replace the train wheel setting lever.

(2) Check the clearance with the crown at second click position.

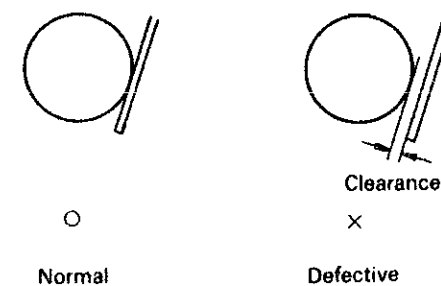

Result:
No clearance: Normal
Clearance: Defective
Replace the train wheel setting lever.

2. Check the output signal with the battery installed.

(1) Check the output signal with the crown at normal position.

Result:
Output signal: Normal
No output signal: Defective
Replace the reset lever

(2) Check the output signal with the crown at second click position.

Result:
No output signal: Normal
Output signal: Defective
Replace the reset lever.

ACCURACY p.13

Use an electromagnetic microphone.

CURRENT CONSUMPTION

1. Use the Digital Multi Tester S-840A and Multi Adapter MA-40.

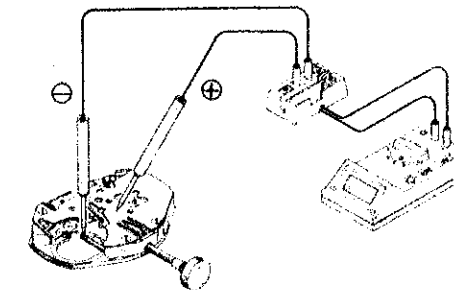

Result:
1.2 μ A or less: Normal

More than 1.2 μ A: Defective
Proceed to 2

NOTE:

Press the reset switch to read 00.0 μ A and measure the current consumption.

Red probe → Winding stem holder
Black probe → Battery connection (-)

When measuring the current consumption under the incandescent lamp, cover the movement with black cloth. Otherwise the measured value sometimes becomes higher than the actual value.

2. Check the current consumption of the circuit block.

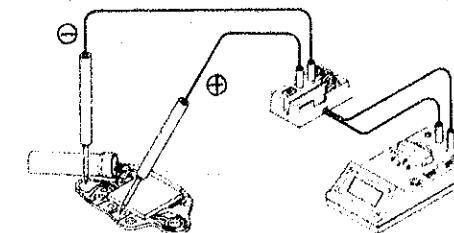

Result:
0.3 μ A or less: Circuit block is normal.

Check the gear train mechanism.
More than 0.3 μ A: Circuit block is defective.
Replace the circuit block.

CHECK WATER RESISTANCE p.15

CHECK APPEARANCE AND FUNCTION p.15

PARTS LIST

CAL. V247A·B & V248A·B

Cal. V247A	Cal. V247B (Jewels: 1j)	Cal. V248A	Cal. V248B (Jewels: 1j)	PARTS NAME
125 234	125 234	125 234	125 234	Train wheel bridge
-	-	*170	*170	Day star with dial disk
195 230	195 230	195 230	195 230	Calendar plate
197 233	197 233	197 233	197 233	Winding stem cock with battery connection (-)
231 233	231 233	231 233	231 233	Third wheel & pinion
-	*241 108	*241 109	*241 109	Fourth wheel & pinion
*241 233	*241 233	*241 231	*241 231	Fourth wheel & pinion
*241 234	*241 234	*241 232	*241 232	Fourth wheel & pinion
261 233	261 233	261 233	261 233	Minute wheel
-	*270 108	*270 109	*270 109	Center minute wheel
*270 243	*270 243	*270 241	*270 241	Center minute wheel
*270 244	*270 244	*270 242	*270 242	Center minute wheel
*271 093	*271 093	*271 091	*271 091	Hour wheel
*271 094	*271 094	*271 092	*271 092	Hour wheel
-	*271 108	*271 109	*271 109	Hour wheel
281 233	281 233	281 233	281 233	Setting wheel
282 233	282 233	282 232	282 232	Clutch wheel
*354 232	*354 232	*354 232	*354 232	Winding stem
*354 233	*354 233	-	-	Winding stem
*354 234	*354 234	*354 234	*354 234	Winding stem
387 234	387 234	387 234	387 234	Minute wheel bridge
391 230	391 230	391 230	391 230	Train wheel setting lever
426 230	426 230	426 230	426 230	Train wheel bridge support
491 233	491 233	491 233	491 233	Dial washer
540 230	540 230	540 230	540 230	Dial leg holder
556 231	556 231	556 230	556 230	Date finger
701 236	701 236	701 236	701 236	Fifth wheel
-	-	719 230	719 230	Day corrector (A)
-	-	719 231	719 231	Day corrector (B)
* 735 236	* 735 255	*735 233	*735 251	Winding stem holder
766 230	766 230	766 230	766 230	Intermediate minute wheel
*801 130	*801 130	*801 128	*801 128	Date dial
*801 131	*801 131	*801 317	*801 317	Date dial
*801 315	*801 315	-	-	Date dial
*801 324	*801 324	-	-	Date dial
802 230	802 230	802 230	802 230	Date driving wheel
808 231	808 231	808 230	808 230	Date dial guard
884 231	884 231	884 230	884 230	Holding ring for dial
-	-	963 230	963 230	Snap for day star with dial disk
4000 220	4000 220	4000 220	4000 220	Circuit block
4002 240	4002 240	4002 240	4002 240	Coil block
4146 236	4146 236	4146 236	4146 236	Step rotor
4225 233	4225 233	4225 233	4225 233	Battery clamp
4239 233	4239 233	4239 233	4239 233	Rotor stator
4408 235	4408 235	4408 235	4408 235	Winding stem holder support
4455 233	4455 233	4455 233	4455 233	Reset lever
011 334	011 334	011 334	011 334	Upper hole jewel for step rotor
011 334	-	011 334	-	Lower hole jewel for step rotor
012 019	012 019	012 019	012 019	Circuit block screw
012 020	012 020	012 020	012 020	Train wheel bridge screw
-	-	012 022	012 022	Date driving wheel screw
012 023	012 023	012 023	012 023	Battery clamp screw
012 825	012 825	012 825	012 825	Winding stem holder screw
012 826	012 826	012 826	012 826	Date dial guard screw
033 019	033 019	033 019	033 019	Reset pin
SEIKO (SEIZAIKEN) TR621SW MAXELL SR621SW U.C.C. 364 SONY EVEREADY 364	SEIKO (SEIZAIKEN) TR621SW MAXELL SR621SW U.C.C. 364 SONY EVEREADY 364	SEIKO (SEIZAIKEN) TR621SW MAXELL SR621SW U.C.C. 364 SONY EVEREADY 364	SEIKO (SEIZAIKEN) TR621SW MAXELL SR621SW U.C.C.364 SONY EVEREADY 364	Battery

REMARKS:

WINDING STEM HOLDER FOR PULSAR WATCHES

V247A 735237 (Pulsar marking) V248A 735234 (Pulsar marking)
V247B 735256 (Pulsar marking) V248B 735252 (Pulsar marking)

Remarks:

★ Day star with dial disk (V248)

Parts No.	Combination of language	Ground color	Figure color
170147	English + Spanish	White	Black
170137	English + Spanish	Black	White
170148	English + French	White	Black
170138	English + French	Black	White
170150	English + Italian	White	Black
170140	English + Italian	Black	White
170014	English + Japanese	White	Black
170136	English + Japanese	Black	White
170155	English + Roman Numeral	White	Black
170145	English + Roman Numeral	Black	White
170153	English + Arabic	White	Black
170143	English + Arabic	Black	White
170149	English + German	White	Black
170139	English + German	Black	White
170154	English + Persian	White	Black
170144	English + Persian	Black	White
170152	English + Chinese	White	Black
170142	English + Chinese	Black	White
170151	English + Portuguese	White	Black
170141	English + Portuguese	Black	White

Used for both crown and calendar frame at 3 o'clock position.

If any other type of day star with dial disk is required, specify the number printed on the disk.

★ Fourth wheel & pinion, Center minute wheel, Hour wheel
There are three different types as specified below.

Combination:

Cal.	Type	Fourth wheel & pinion	Center minute wheel	Hour wheel
V247A, B	M	241 233	270 243	271 093
	L	241 234	270 244	271 094
	LL	241 108	270 108	271 108
V248A, B	M	241 231	270 241	271 091
	L	241 232	270 242	271 092
	LL	241 109	270 109	271 109

* Abbreviation M..... Standard type
(Movement type) L..... Long type
LL..... Super long type

★ Winding stem

The type of winding stem is determined based on the design of case. Check the case number and refer to "Casing Parts Catalogue" to choose a corresponding winding stem.

★ Date dial

801 128 (Black figures on white background)
801 130 (Black figures on white background)
801 315 (White figures on black background)
801 317 (White figures on black background)

Used when both the crown and the calendar frame are located at 3 o'clock position.

801 131 (Black figures on white background)
801 324 (White figures on black background)

Used when the crown is located at 3 o'clock and the calendar frame is at 6 o'clock position.

If any other type of date dial is required, specify ① Cal. No. ② Jewels ③ The crown position ④ The calendar frame position and ⑤ Dial No.