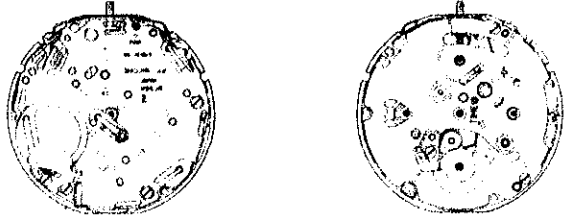

PARTS CATALOGUE/TECHNICAL GUIDE

Cal. N94JA

[SPECIFICATIONS]

Cal. No.		N94JA		
Item				
Movement		 <p style="text-align: right;">(x 1.0)</p>		
Movement size	Outside diameter	ø27.0 mm 26.0 mm between 3 o'clock and 9 o'clock sides		
	Casing diameter	ø26.0 mm		
	Height	3.62 mm (Including the battery portion)		
Time indication		Main time	Chronograph	World time
		Hour hand Minute hand Date indicator	1/10 seconds Seconds Minutes Hour	Time zone indicator Minute hand Hour hand
Driving system		Step motor, 3 pieces		
Additional mechanism		<ul style="list-style-type: none"> • Alarm function (24-hour indication system) • Stopwatch function (Up to 12-hours in 1/10 seconds) • World time function (Selection among 24 cities in different time zones) • Hands 0-reset adjustment function • Alarm test system 		
Loss/gain		Monthly rate at normal temperature range: less than 20 seconds		
Regulation system		Nil		
Measuring gate by quartz tester		Use 10-second gate.		
Battery		SEIKO SR927W, Maxell SR927W, SONY SR927W, EVEREADY 399 Battery life is approximately 3 years. Voltage: 1.55V		
Jewels		0 jewel		

SEIKO CORPORATION





PARTS CATALOGUE

Cal. N94JA

Disassembling procedure Figs. : ① → ⑥⑥

Reassembling procedure Figs. : ⑥⑥ → ①

Lubricating: Types of oil Oil quantity

 Moebius A  Normal quantity
 Silicone Oil 500,000 c.s.  Extremely small

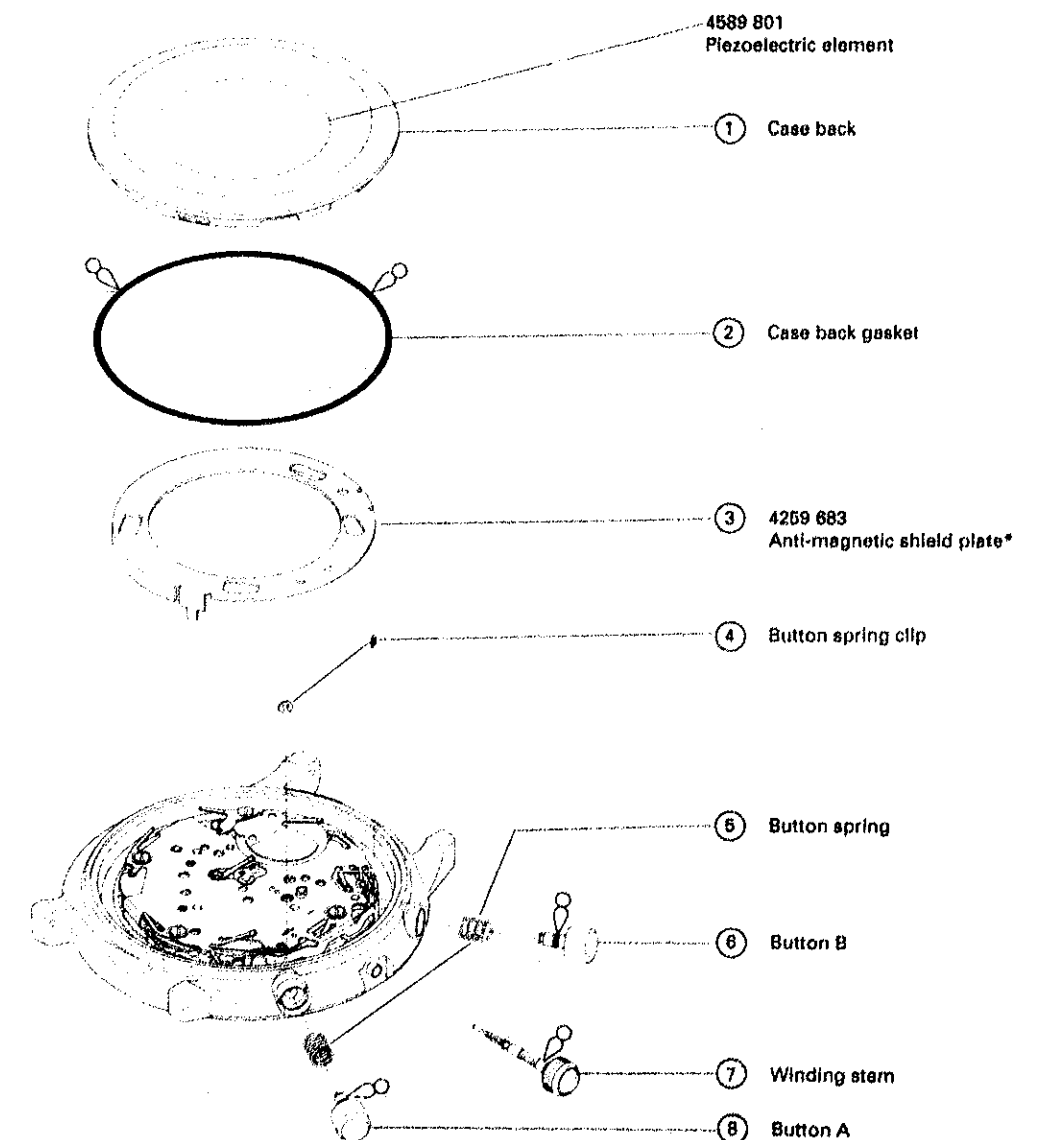

* Anti-magnetic shield plate may or may not be used depending on models.

 Please see the remarks on the following pages.

PARTS CATALOGUE

Cal. N94JA

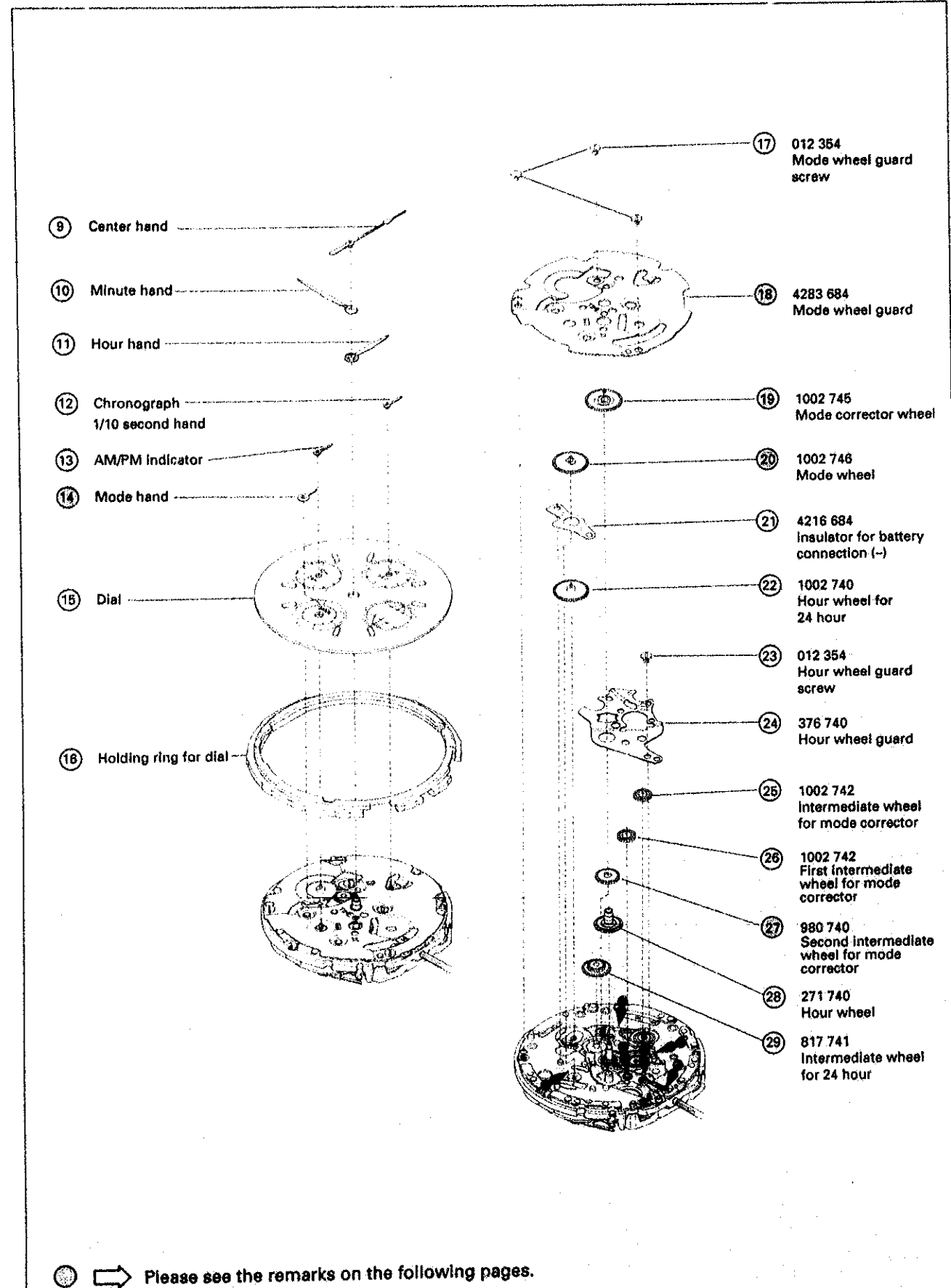

PARTS CATALOGUE

Cal. N94JA

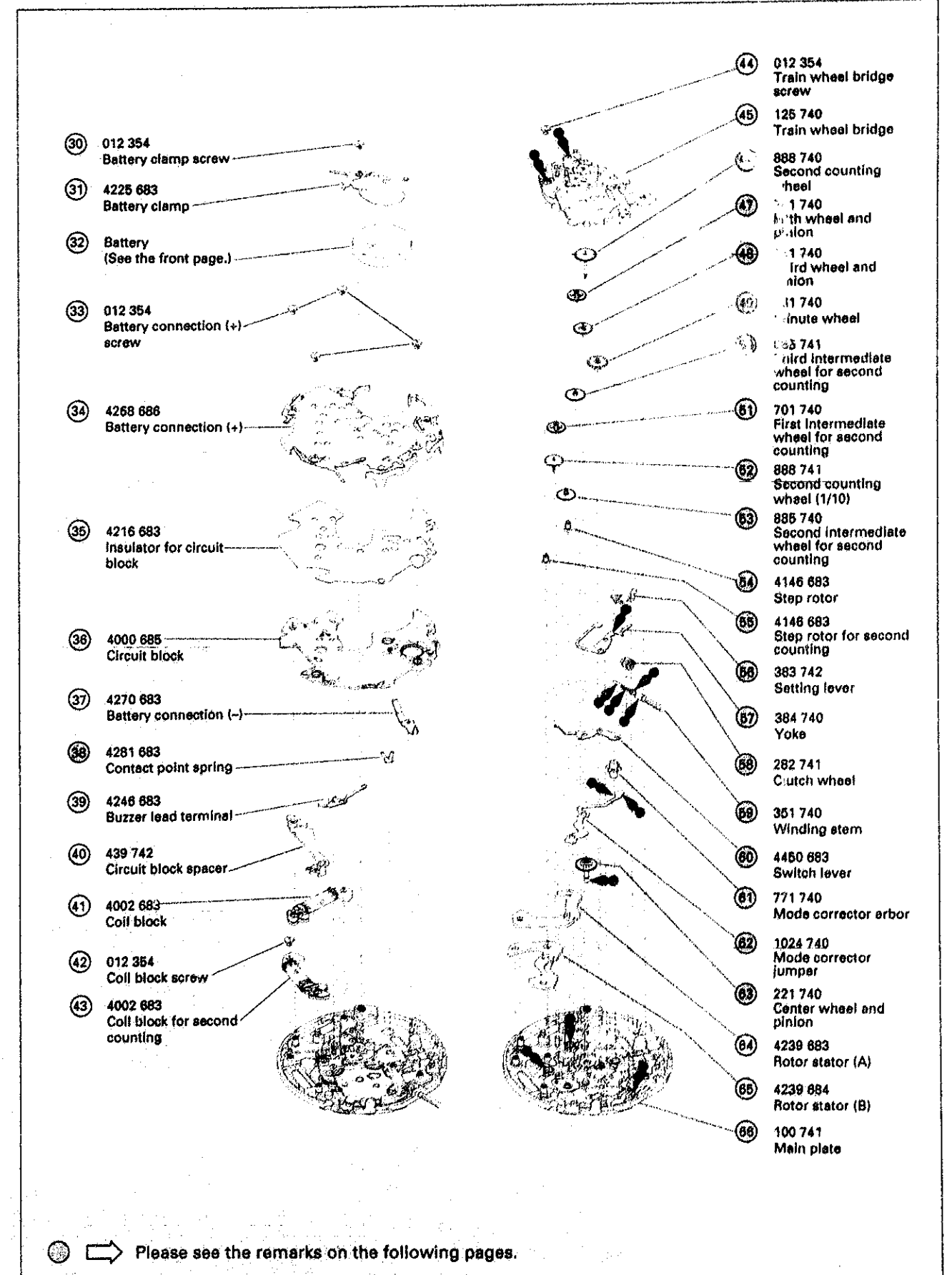

TECHNICAL GUIDE

Cal. N94JA

- The explanation here is only for the particular points of Cal. N94JA.
- For repairing, checking and measuring procedures, refer to the "TECHNICAL GUIDE, GENERAL INSTRUCTIONS".

I. STRUCTURE OF THE CIRCUIT BLOCK

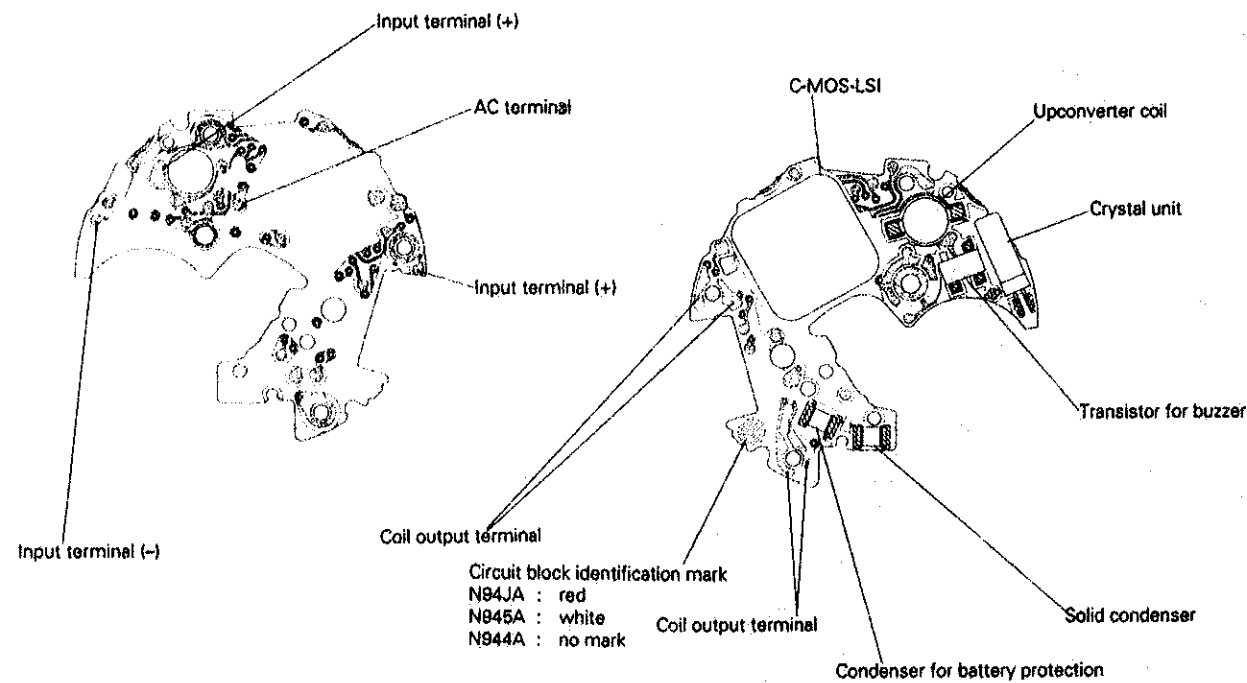

II. REMARKS ON INSTALLING THE BATTERY

- A necessary step after installing the battery
- After the battery is replaced with a new one, or after the battery is removed and re-installed following the repairing procedure, be sure to short-circuit the AC terminal and the battery connection (+) with conductive tweezers as shown in the illustration below to reset the circuit.

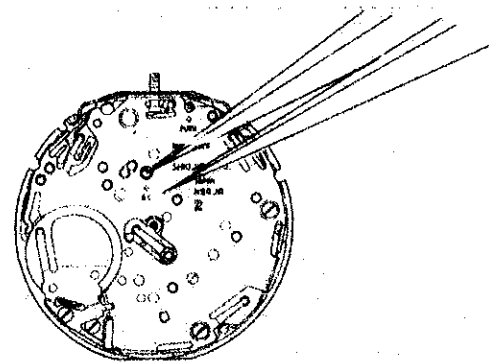

TECHNICAL GUIDE

Cal. N94JA

- After resetting the circuit, adjust the hand position.

- Pressing button "A" turns the hands clockwise.
- Pressing button "B" turns the hands counterclockwise.

1. Turn the crown to set the mode hand to "→ ∅ ←".

Pull out the crown to the first click and reset the 1/10 second and center hands to the 12 o'clock position.

Pull out the crown to the second click and reset the hour and minute hands to the 12 o'clock position.

Push the crown back in to the normal position.

2. Turn the crown to set the mode hand to "W.T."

To show the regular time

Pull out the crown to the second click and set the center hand to the city representing your time zone.

Push the crown back in to the normal position.

To show the daylight saving time

Pull out the crown to the second click, set the center hand to the city representing your time zone, and then press button "A" to turn the center hand clockwise by one time zone.

Push the crown back in to the normal position.

3. Turn the crown to set the mode hand to "TIME".

Pull out the crown to the first click and set the center hand to the current date of your local area.

Pull out the crown to the second click and set the hour and minute hands to the current time of your local area.

* When setting the hour hand, check that the AM/PM indicator is correctly set.

TECHNICAL GUIDE

Cal. N94JA

III. REMARKS ON DISASSEMBLING AND REASSEMBLING

14 Mode hand

Face the cut surface of the mode wheel's shaft toward the 6 o'clock position, and then install the mode hand so that it points to "TIME".

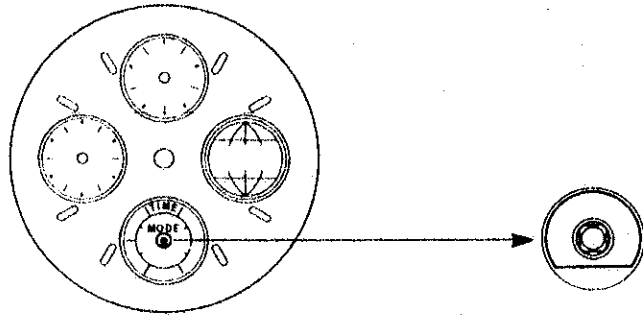

18 Mode wheel guard

19 Mode corrector wheel

20 Mode wheel

Before installing the mode wheel guard, be sure to check the following:

1. The hole on the mode corrector wheel is positioned toward the center of the movement.
2. The cut surface of the mode wheel's shaft faces toward the 6 o'clock position, and is in line with the straight edge of the insulator for battery connection (-).

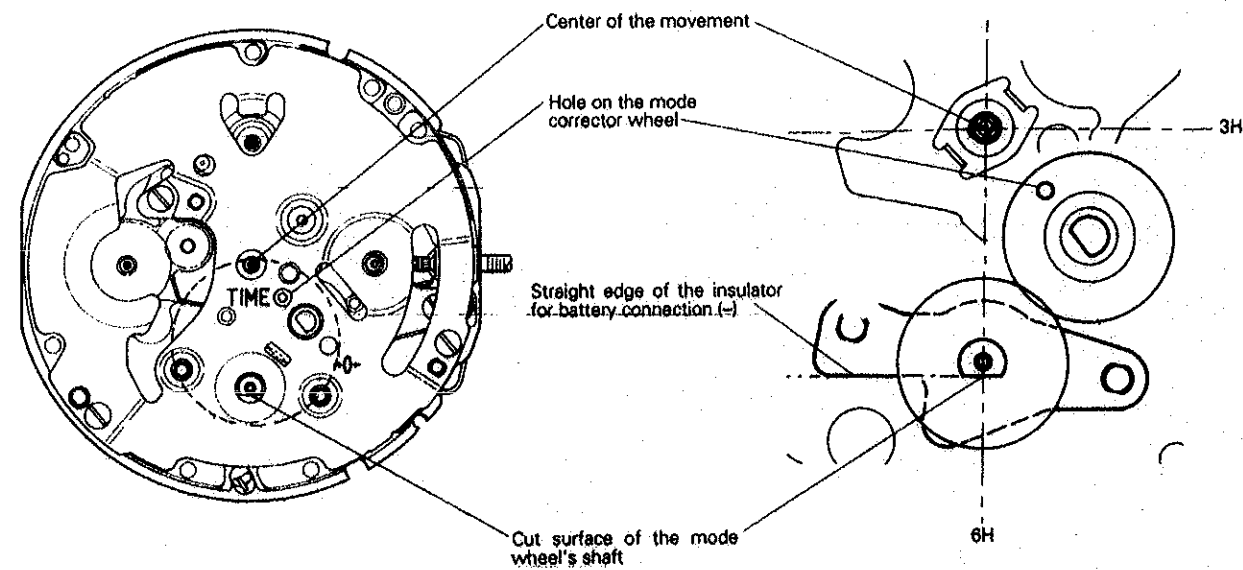

TECHNICAL GUIDE

Cal. N94JA

27 Second intermediate wheel for mode corrector

Set the second intermediate wheel for mode corrector to the mode corrector arbor so that they fit together.

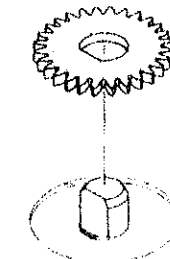

38 Contact point spring

Set the contact point spring to the mode corrector wheel so that they fit together.

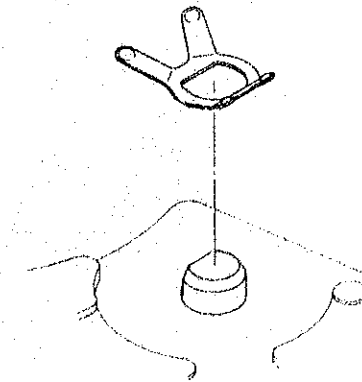

46 Second counting wheel ~ 63 Center wheel and pinion

• Setting position of the train wheel

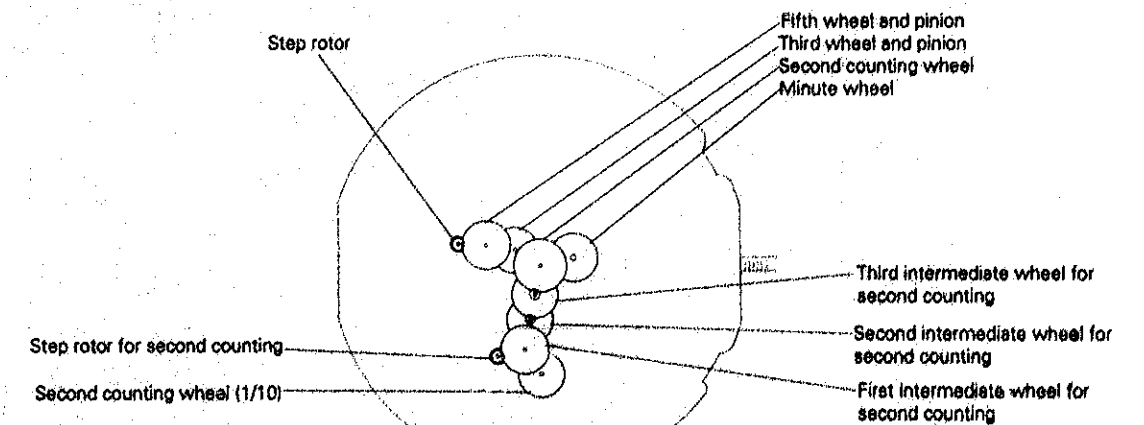

TECHNICAL GUIDE

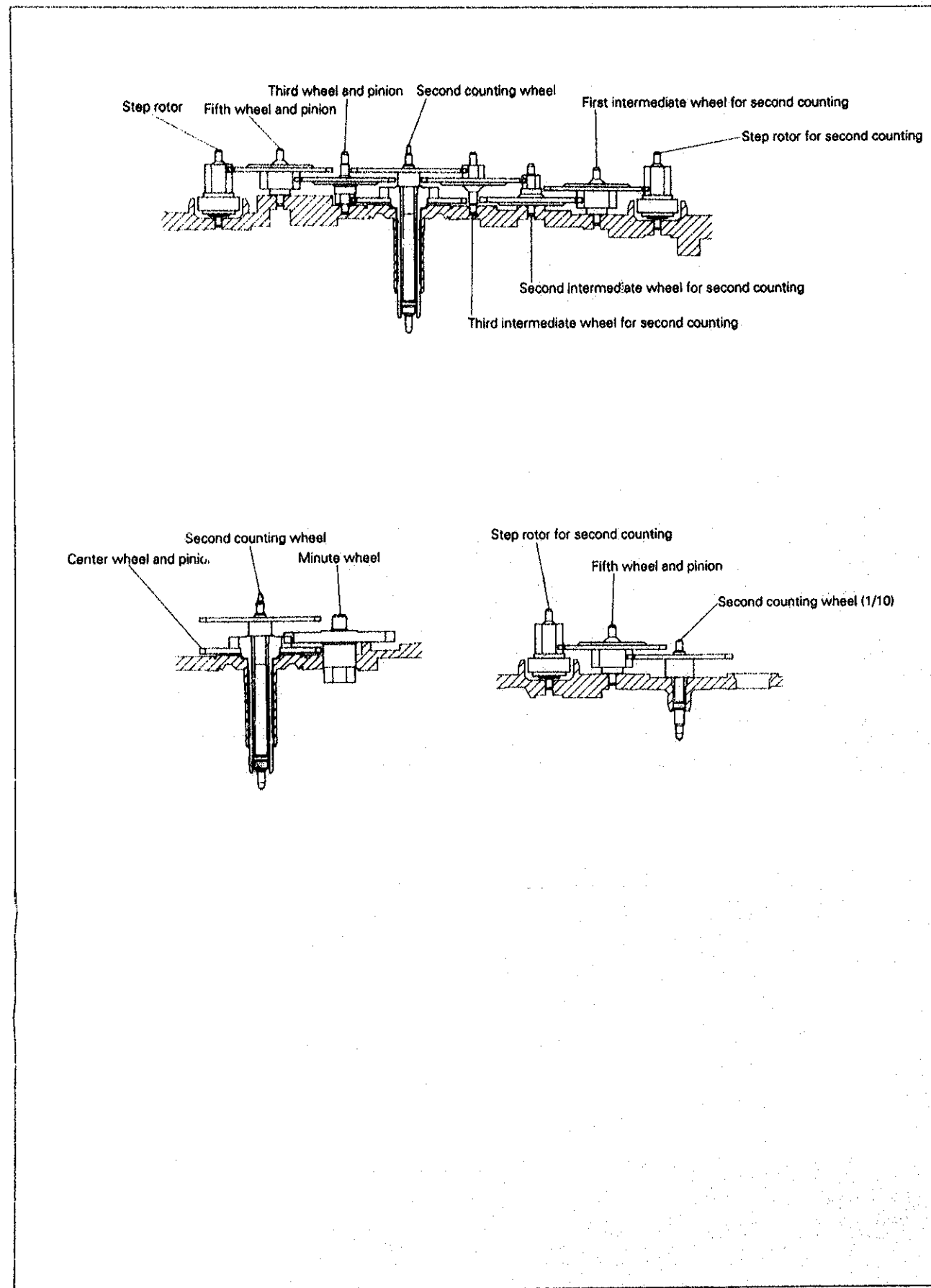

Cal. N94JA



TECHNICAL GUIDE

Cal. N94JA

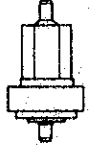
• Distinction of the wheels

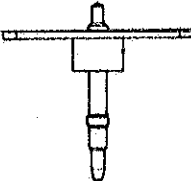
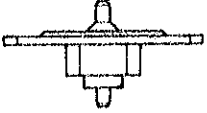
Name	Step rotor Step rotor for second counting	Second intermediate wheel for second counting	Second counting wheel (1/10 second)	Fifth wheel and pinion First intermediate wheel for second counting
Shape	 4146 683	 885 740	 888 741	 701 740
Distinctive feature		• Color : White • Identification mark	Material : Metal	• Color : White • Identification mark

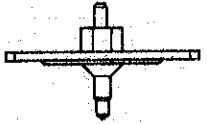
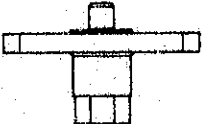
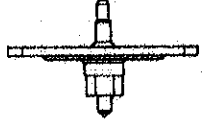
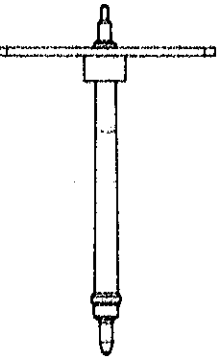
Name	Third intermediate wheel for second counting	Minute wheel	Third wheel and pinion	Second counting wheel
Shape	 885 741	 261 740	 231 740	 888 740
Distinctive feature	• Color : White • Identification mark	• Color : White	• Color : Uncolored (Gray) • Identification mark	Material : Metal

TECHNICAL GUIDE

Cal. N94JA

- ⑥⑥ Setting lever
- ⑥⑦ Yoke
- ⑥⑧ Clutch wheel
- ⑥⑨ Winding stem
- ⑥⑩ Switch lever

▼ **Setting position of the mode changing parts**

Set the mode changing parts so that the tube of the setting lever is positioned in the hole of the switch lever.

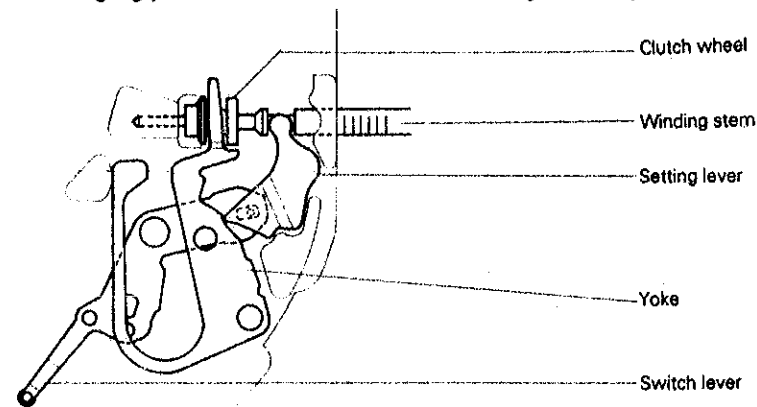

- ⑥① Mode corrector arbor
- ⑥② Mode corrector jumper

- To set the mode corrector arbor, face its cut surface toward the battery portion of the main plate.
- First, press down securely to set the two holes ① and ② of the mode corrector jumper to the pins of the movement in order. Then, engage the end portion of the mode corrector jumper with the teeth of the mode corrector arbor.

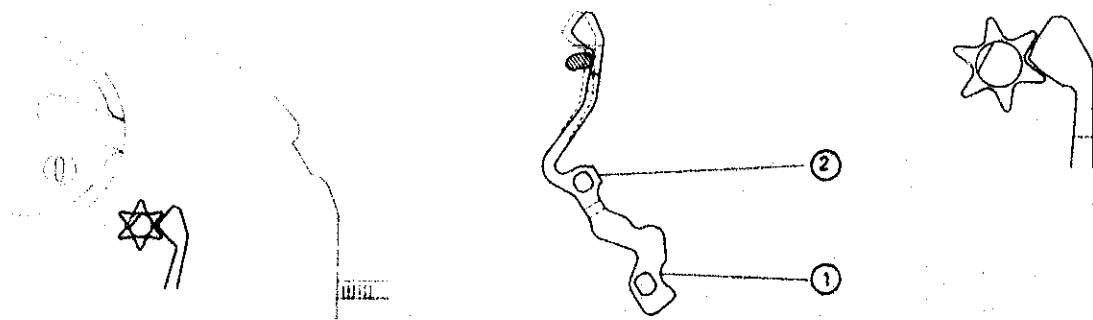

TECHNICAL GUIDE

Cal. N94JA

IV. VALUE CHECKING

• **Coil block resistance**

1.2K Ω ~ 1.8K Ω

• **Upconverter coil resistance**

110 Ω ~ 140 Ω

• **Current consumption**

For the whole of the movement: less than 1.2 μ A
 For the circuit block alone : less than 0.9 μ A

* To measure the current consumption for the whole of the movement, set the mode to "TIME". After power is supplied, be sure to reset the circuit before measuring current consumption.