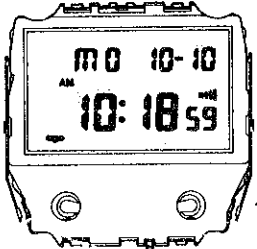
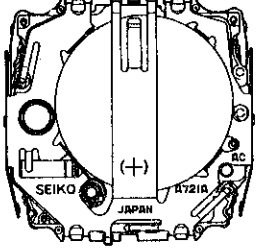

PARTS CATALOGUE / TECHNICAL GUIDE

Cal. A721A

[SPECIFICATIONS]

Item		Cal. No.	A721A
Module			  <p style="text-align: center;">(x 1.2)</p>
Module size	Outside diameter		27.5mm between 6 o'clock and 12 o'clock sides 27.5mm between 3 o'clock and 9 o'clock sides
	Casing diameter		--
	Height		5.0mm including the battery portion
Display medium			Nematic Liquid Crystal, FEM (Field Effect Mode)
Liquid crystal driving system			1/4 multiplex driving system
Display system			<ul style="list-style-type: none"> • Time/calendar display (12- or 24-hour indication) • Stopwatch display (up to 10 hours) <ul style="list-style-type: none"> • Split time measurement • Lap time measurement • Alarm display
Additional mechanism			<ul style="list-style-type: none"> • Memory function (up to 100 measurements) • Alarm test system • Confirmation sound for watch operation • Illuminating light
Loss/gain			Monthly rate at normal temperature range: less than 20 seconds
Regulation system			Nil
Measuring gate by quartz tester			Any gate can be used.
Battery			SEIKO CR2016, Maxell CR2016, Sanyo CR2016, Matsushita CR2016, EVEREADY CR2016 Battery life is approximately 2 years. Voltage: 3.0V

PARTS CATALOGUE

Cal. A721A

Disassembling procedures Figs. : ① → ⑪

Reassembling procedures Figs. : ⑪ → ①

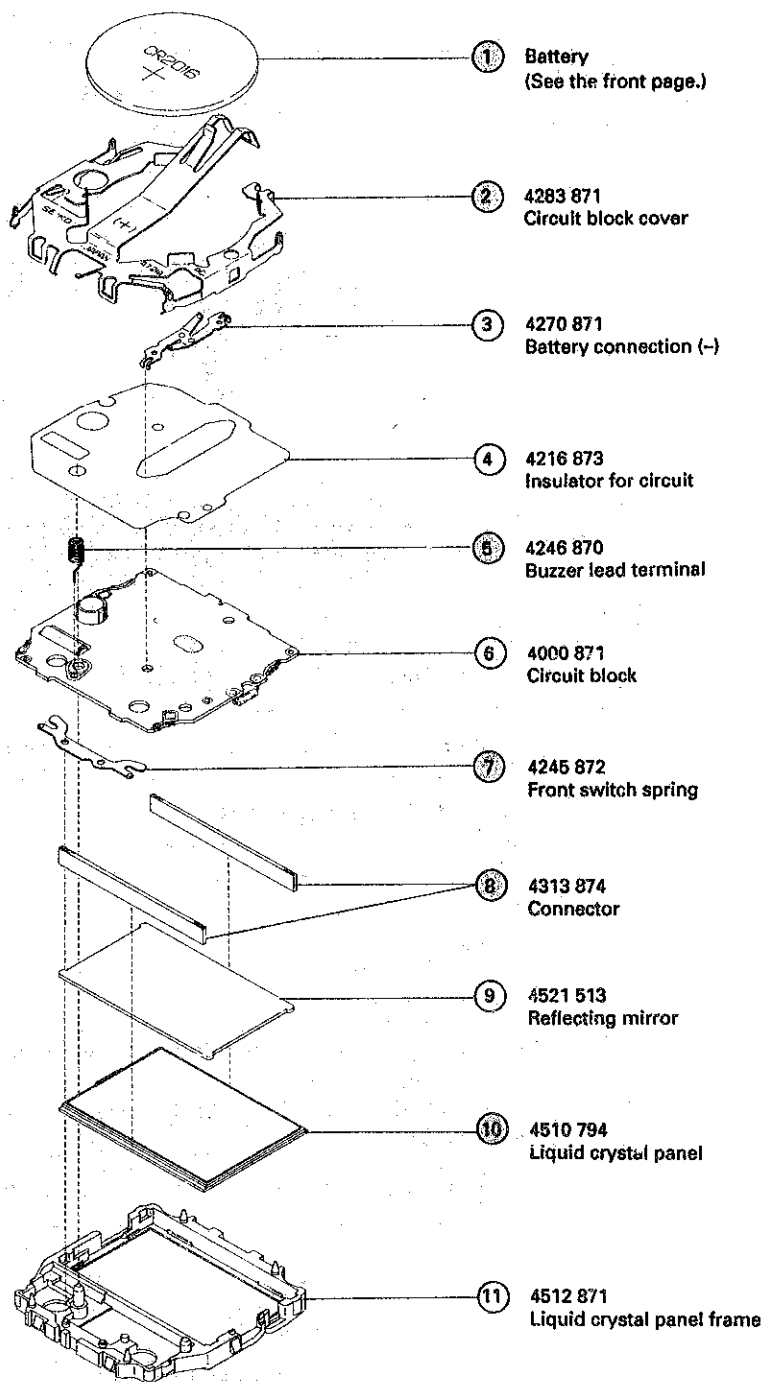

- Other parts
- Piezoelectric element 4589 650
- Adhesive tape for buzzer 4216 534

⊙ ⇨ Please see the remarks on the following pages.

- The explanation here is only for the particular points of Cal. A721A.
- For the repairing, checking and measuring procedures, refer to the "TECHNICAL GUIDE, GENERAL INSTRUCTIONS".

I. STRUCTURE OF THE CIRCUIT BLOCK

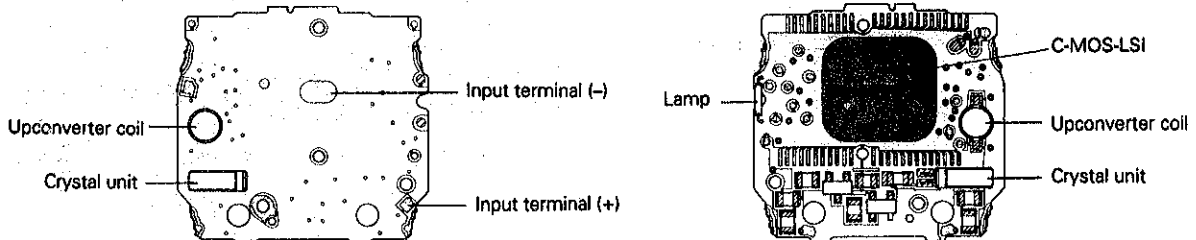

II. REMARKS ON INSTALLING THE BATTERY

After the battery is replaced with a new one, or after the battery is re-installed following the repairing procedures, be sure to short-circuit the AC terminal of the circuit block and the circuit block cover with conductive tweezers as illustrated at right to reset the circuit.

When the circuit reset is completed, "12:00" appears on the display and flashes for 2 to 3 minutes.

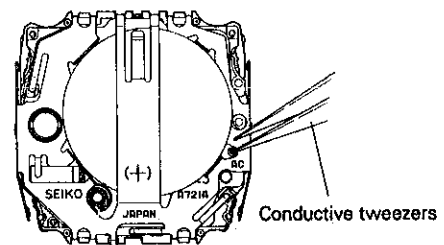

III. REMARKS ON DISASSEMBLING AND REASSEMBLING

Use the universal movement holder for disassembling and reassembling.

- **Note on installing the module to the case**
Before installing the module to the case, be sure to push out the buttons "A", "B", "C" and "D" toward outside the case as shown in the illustration.

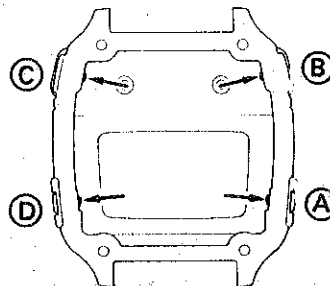

① Battery

• How to remove

Detach the hooking portion A of the circuit block cover and remove the battery.

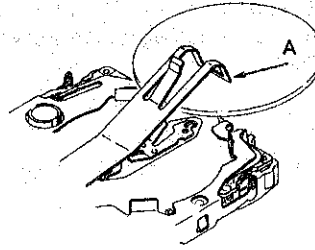

• How to install

While installing the battery, keep it level to avoid short circuit.

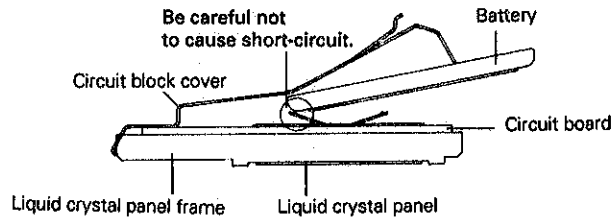

② Circuit block cover

Set all the hooking portions securely.

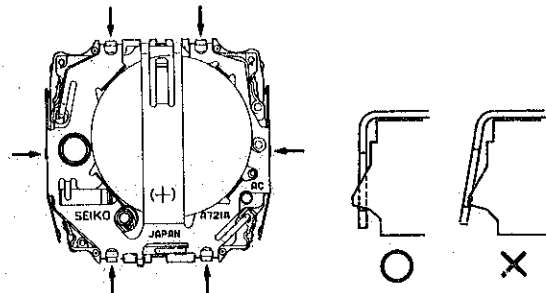

⑤ Buzzer lead terminal

Set the buzzer lead terminal as shown in the illustration.

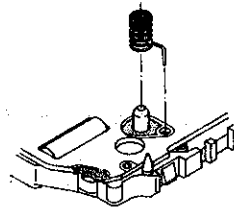

⑦ Front switch spring

• How to install

Set the front switch spring with the (A) portions up as shown in the illustration. (Check that the notched portion is on the lower right side.)

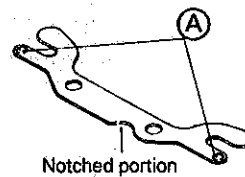

⑧ Connector

Set the two connectors as shown in the illustration.

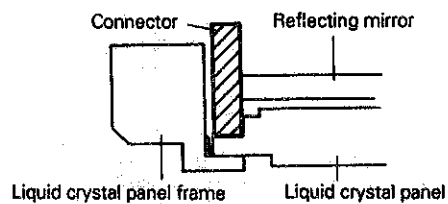

⑩ Liquid crystal panel

• **Setting position**

Set the liquid crystal panel with its sealing part on the left-hand side.

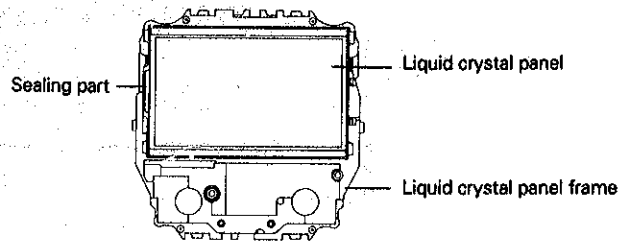

IV. VALUE CHECKING

• **Current consumption**

For the whole of the module: less than 1.8 μ A
 For the circuit block alone : less than 1.5 μ A

• **Upconverter coil resistance**

80 Ω ~ 120 Ω

• **Time accuracy**

To measure accuracy, light up all the segments of the display.
 Note that the time accuracy cannot be adjusted even if it is found defective.

• **All the segments lit up**

- (1) Press button "A" to show the TIME/CALENDAR display.
- (2) Press "B" to show the TIME SETTING display.
- (3) Press buttons "A", "C" and "D" at the same time.
- (4) Check that all the segments light up as shown in the illustration below.

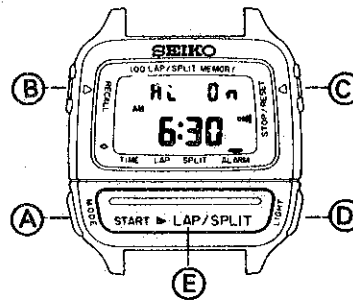
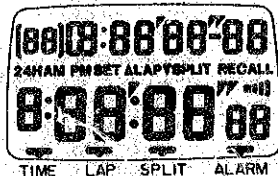

- (5) To return to the TIME/CALENDAR display, press any one of "A", "B", "C", "D" and "E".

• **Alarm test**

- (1) Press button "A" to show the ALARM display.
- (2) The alarm rings if button "C" is pressed for more than 2 seconds.

• **Illuminating light**

- (1) Press button "D" and check that the light illuminates the display. (The display remains illuminated for 3 to 4 seconds after the button is released.)

TECHNICAL GUIDE

Cal. A721A

• Display change in the TIME/CALENDAR display

- (1) Press "A" to show the TIME/CALENDAR display.
- (2) Check if the display changes alternately between the 12- and 24-hour indications, with each press of button "C".
- (3) Check if the display changes as follows with each press of button "B".

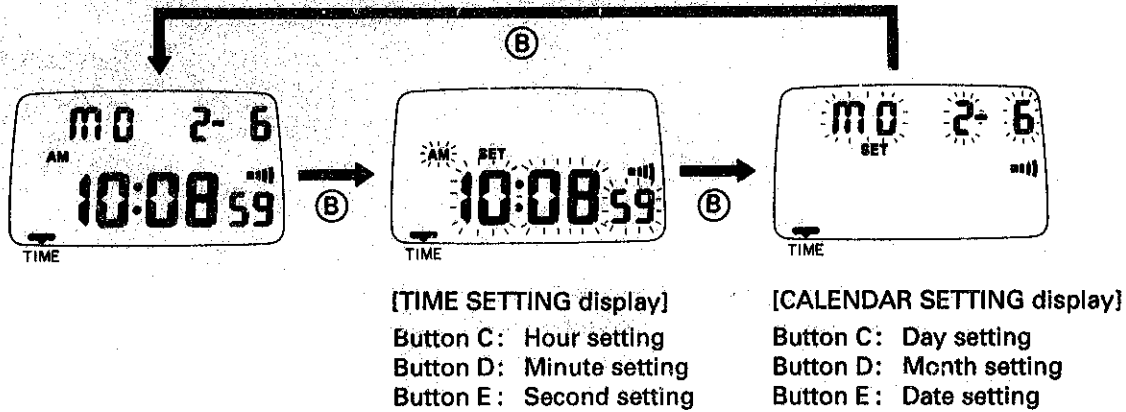

Note: If the watch is left untouched in the TIME SETTING or CALENDAR SETTING display, the display will automatically return to the TIME/CALENDAR in 1 to 2 minutes.

• Stopwatch measurement

- (1) Press button "A" to show the SPLIT TIME display.
(The checking procedure in the LAP TIME display is the same as that in the SPLIT TIME display.)
- (2) Press "C" to reset the digits to "0". (When the stopwatch is measuring, press button "C" twice to reset it to "0".)

The stopwatch has been reset to "0".

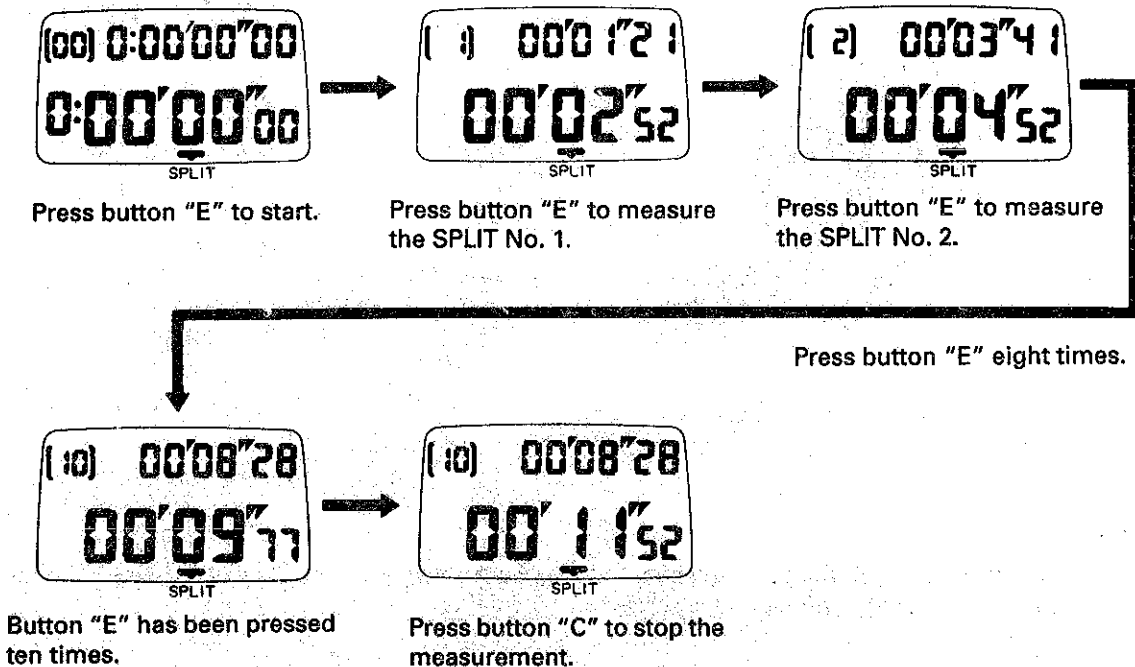

- (3) Press button "B" to activate the memory recall function.
 - (4) The stored data are displayed one by one with each press of button "E".
 - (5) To make a new measurement, first press button "C" to reset the stopwatch to "0".
- *When a new measurement is started by pressing button "E", all the stored data will be erased.

• Alarm time setting and alarm engagement/disengagement

- (1) Press button "A" to show the ALARM display.
- (2) Check that "AL ON" (alarm engaged) and "AL OFF" (alarm disengaged) marks appear alternately with each press of button "C".
- (3) Press "B" in the ALARM display to check that the digits start flashing.

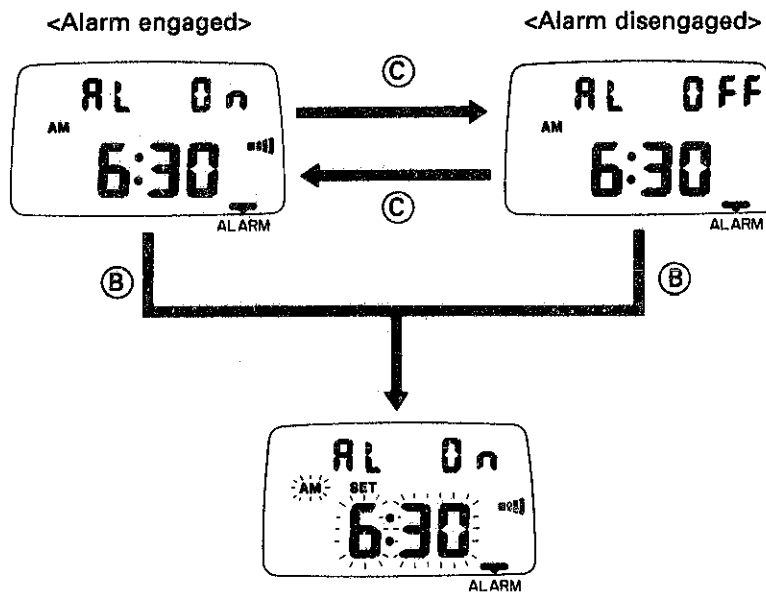

[ALARM SETTING display]

Button C: Hour setting
 Button D: Minute setting

Notes:

- 1. The alarm rings at the designated time for 20 seconds.
- 2. The alarm can be stopped by pressing any one of "A", "B", "C", "D" and "E".
- 3. If the watch is left untouched in the ALARM or ALARM SETTING display, it will automatically return to the TIME/CALENDAR display in 1 to 2 minutes.