

SEIKO

DIGITAL QUARTZ

Cal. A239A

PARTS LIST

Cal. A239A

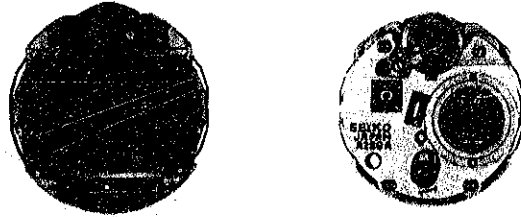

4001 234



4216 230



4216 231



4242 230



4242 231



4242 232



4245 230



4245 231



4270 230

4313 230

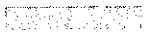

4313 234



4398 241

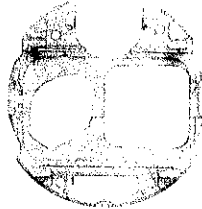

4398 244

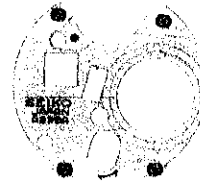

4398 245



4446 230

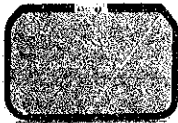

☆ 4510 183

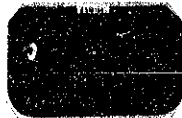

☆ 4510 184

4521 230



4530 230



4540 233



4540 234



4580 231



4991 231



☆ SEIKO TR926W



012 158



012 458



017 144



017 145

3/1

Cal. A239A

Characteristics

Casing diameter : ϕ 28.0 mm
 Maximum height : 6.0 mm without battery
 Frequency of quartz crystal oscillator : 32,768 Hz (Hz = Hertz Cycles per second)
 Home time and calendar display : Digital Display System showing hour, minute, second, AM, PM., day of the week, date and month.
 World time and calendar display : Digital Display System showing hour, minute, AM./PM., time zone indicator and time zone.
 At the push of a button, the calendar (month, date and day of the week) will be displayed for any of the available world times.
 Alarm display : It can be set to operate at any desired hour and minute in either the home time or the selected world time.
 Dual alarm tim mechanism : The alarm time set in the home time alarm function is changed to the alarm time in the selected world alarm time function.
 Display medium : Nematic Liquid Crystal, FE-Mode
 Regulation system : Trimmer condenser
 Time signal : It can be set to ring every hour on the hour.
 Illuminating light : Illuminates the display in the dark.

PART NO.	PART NAME	PART NO.	PART NAME
4001 234	Circuit block	017 145	Tube for speaker block lead terminal screw B
4216 230	Insulator for circuit	☆SEIKO TR926W	Silver peroxide battery
4216 231	Insulator for battery		
4242 230	Plus terminal of battery connection		
4242 231	Speaker block lead terminal A		
4242 232	Speaker block lead terminal B		
4245 230	Switch spring A		
4245 231	Switch spring B		
4270 230	Battery connection		
4313 230	Connector A		
4313 234	Connector B		
4398 241	Speaker block frame		
4398 244	Liquid crystal panel frame		
4398 245	Battery guard		
4446 230	Insulating seat		
☆4510 183	Liquid crystal panel (Black)		
☆4510 184	Liquid crystal panel (Red)		
☆4510 185	Liquid crystal panel (Green)		
☆4510 186	Liquid crystal panel (Black)		
4521 230	Reflecting mirror		
4530 230	Bulb		
4540 233	Liquid crystal panel frame A		
4540 234	Liquid crystal panel frame B		
4580 231	Speaker block		
4991 231	Gasket for speaker block		
012 158	Screw for speaker block lead terminal B		
012 458	Liquid crystal panel holder screw		
017 144	Tube for liquid crystal panel holder screw A		

Remarks :

Liquid crystal panel

- ☆4510 183.....Used for the time and calendar display.
- ☆4510 184 }
- ☆4510 185 }Used for the world map display.
- ☆4510 186 }

Be sure that the combination between the design of the case and liquid crystal panel should be matched according to the "SEIKO Quartz Casing Parts List".

Battery

- ☆SEIKO TR926W.....The applied battery for this calibre might be added the substitutive in the future. In that case, please refer to separate "BATTERIES FOR SEIKO QUARTZ WATCHES".

☆⇨Please see remarks.

Part numbers in light letters are not shown in photos.

TECHNICAL GUIDE

SEIKO DIGITAL QUARTZ

CAL. A239A

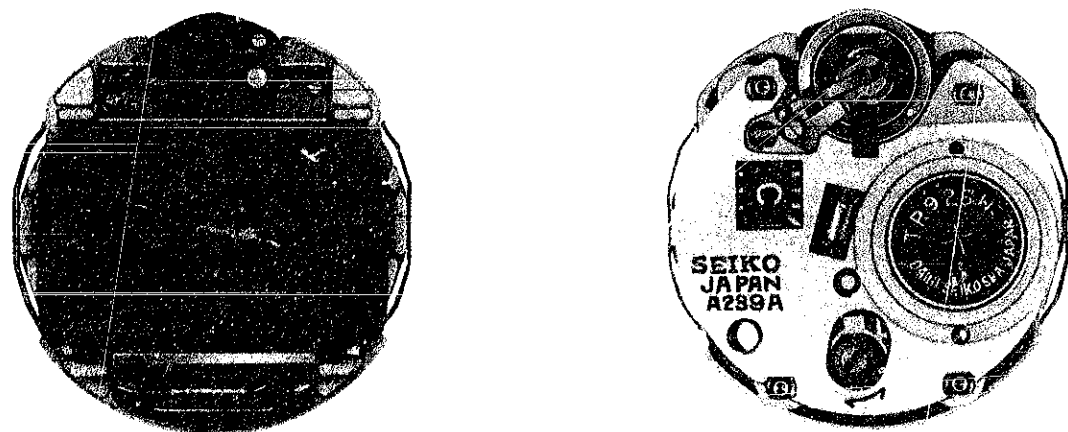

CONTENTS

I. SPECIFICATIONS	1
II. STRUCTURE OF THE CIRCUIT BLOCK	2
III. DISPLAY FUNCTION	3
IV. DISASSEMBLING, REASSEMBLING AND LUBRICATING OF THE CASE	4
V. DISASSEMBLING AND REASSEMBLING OF THE MODULE	6
1. Liquid crystal panel side	6
2. Switch mechanism	8
3. Segment (Liquid crystal panel electrode)	10
VI. CHECKING AND ADJUSTMENT	12
1. Check battery voltage	12
2. Check pattern segment checking system	12
3. Check conductivity of liquid crystal panel, circuit block and connectors	12
4. Check liquid crystal panel and circuit block	13
5. Check current consumption	13
6. Check accuracy	14
7. Check functioning and adjustment	14
8. Check conductivity of switch components	14

I. SPECIFICATIONS

Item	Cal. No.	A239A
Display medium		Nematic Liquid Crystal, FEM (Field Effect Mode)
Liquid crystal driving system		Multiplex driving system
Display system		2-layer liquid crystal panel <ul style="list-style-type: none"> • Home time and calendar display • Home time alarm display • World time display • World time alarm display • World time calendar display
Additional mechanism		<ul style="list-style-type: none"> • Alarm test system • Time signal: It can be set to ring every hour on the hour. • Illuminating light
Loss/gain		Loss/gain at normal temperature range Monthly rate: less than 15 seconds (Annual rate: less than 3 minutes)
Casing diameter		∅28.0 mm
Height		6.0 mm without battery
Operational temperature range		-10°C ~ +60°C (14°F ~ 140°F)
Regulation system		Trimmer condenser
Measuring gate by Quartz Tester		Any gate is available.
Battery		SEIKO TR926W Battery life is approximately 1 year (if the light is used for 5 seconds or less per day and the home time alarm or world time alarm is used for 15 seconds or less per day). Voltage: 1.55 V

II. STRUCTURE OF THE CIRCUIT BLOCK

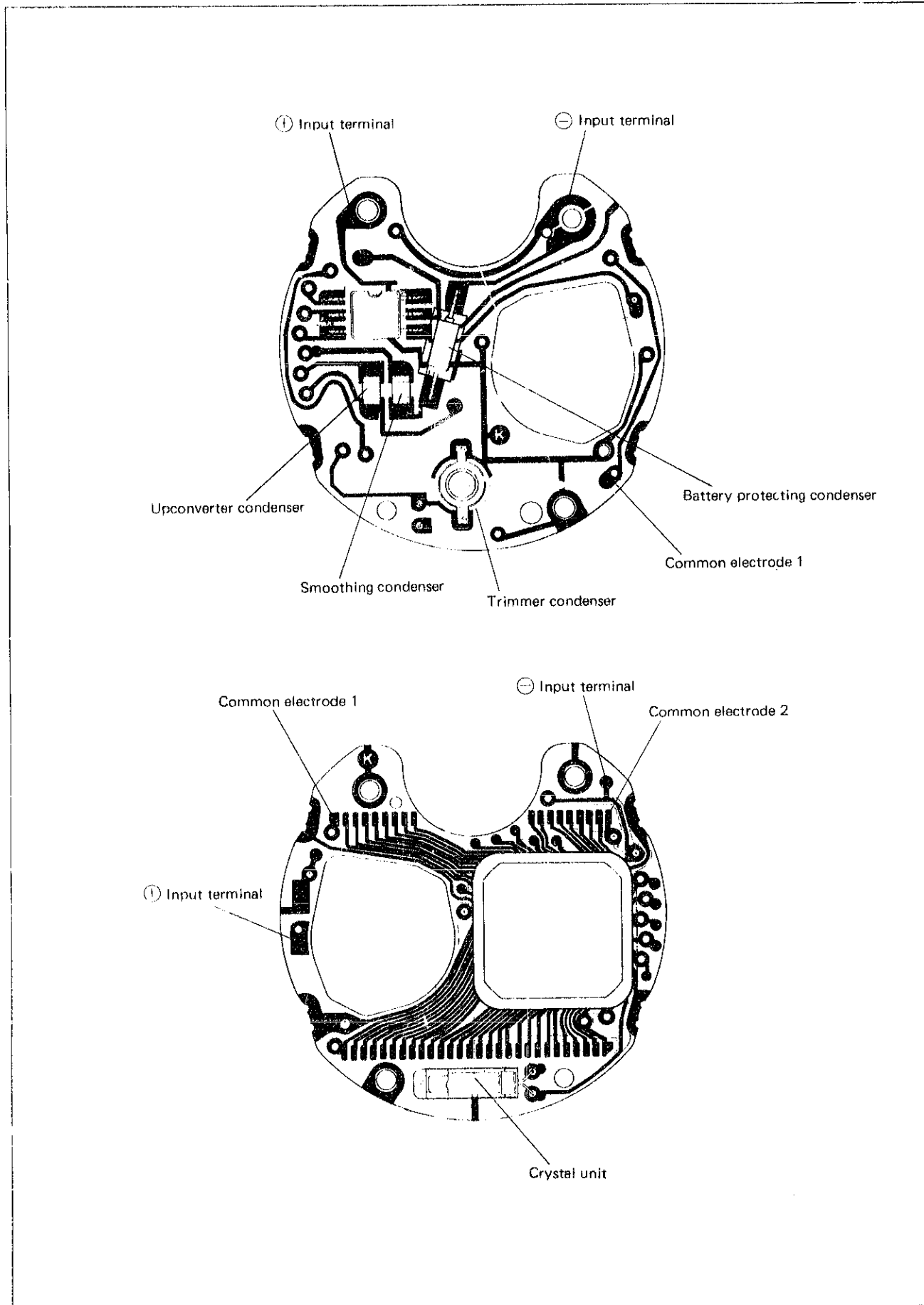

III. DISPLAY FUNCTION

[Home time display]

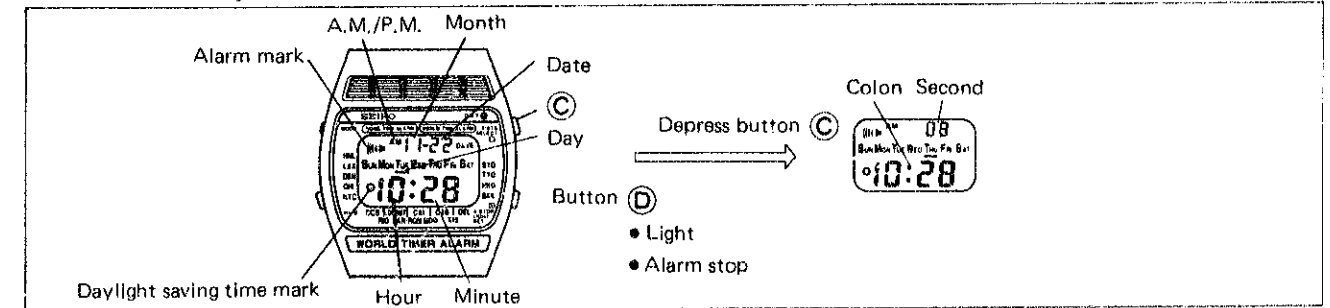

[Home time alarm display]

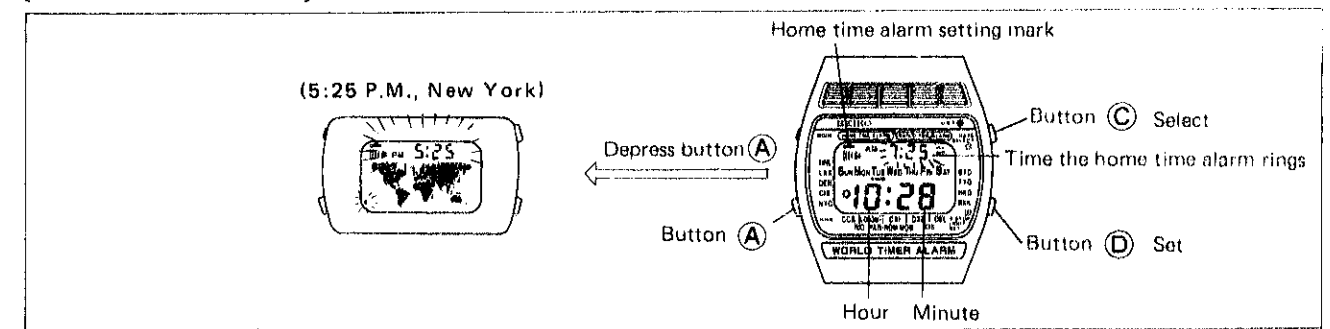

[World time display]

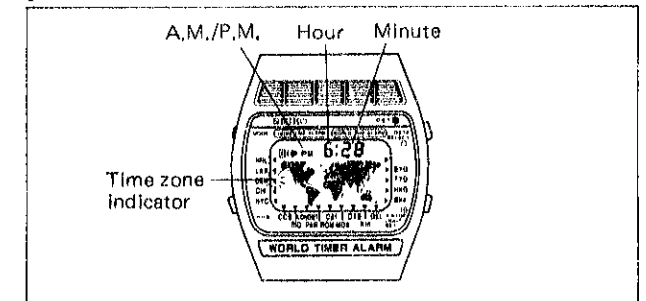

[World time alarm display]

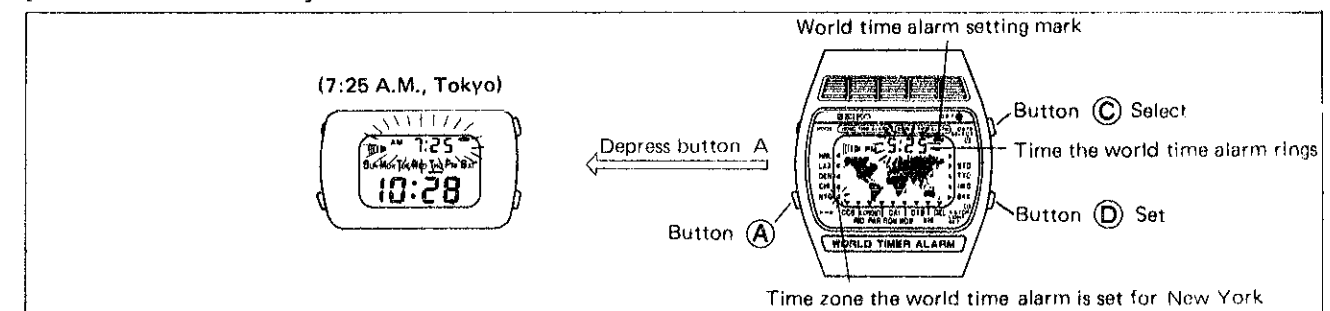

[World time calendar display]

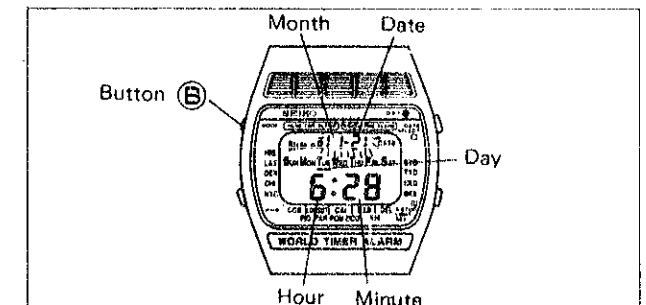

IV. DISASSEMBLING, REASSEMBLING AND LUBRICATING OF THE CASE

Disassembling procedures Figs.: ① → ⑫

Reassembling procedures Figs.: ⑫ → ①

- Lubricating Silicone grease 500,000 c.s.
Normal quantity

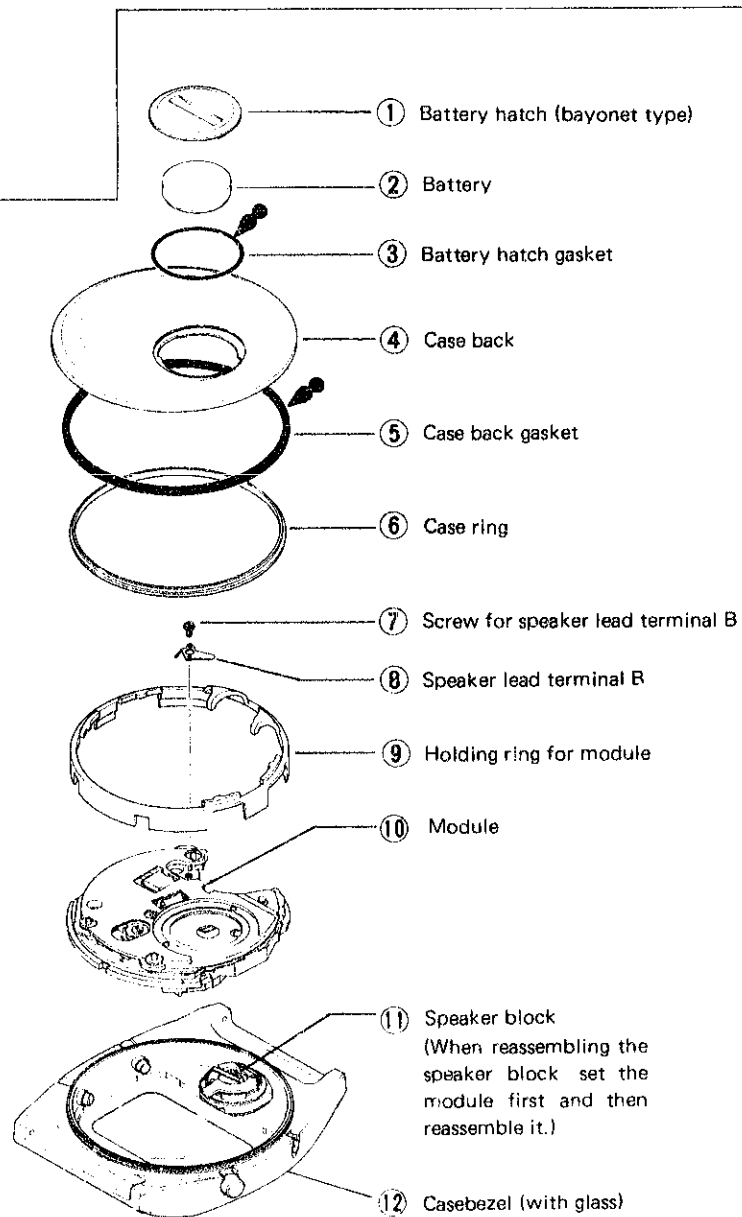

● How to set the case back

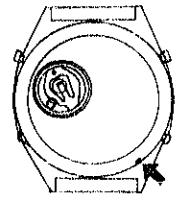

Set the case back in the casebezel so that the notch of the case back lines up to the punch mark on the casebezel. Be careful that the case back gasket does not come out.

● How to disassemble the glass and the buttons

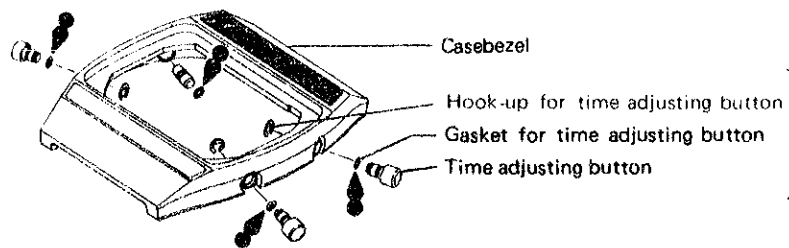
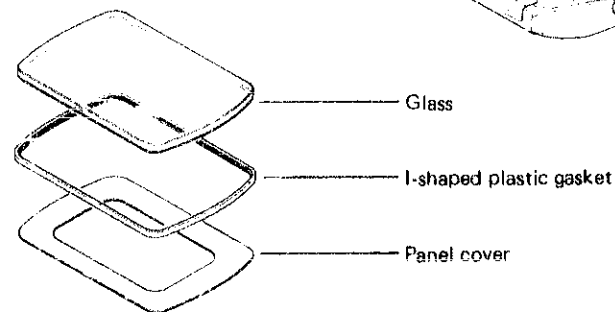

It is not necessary to disassemble them under the normal disassembling and reassembling. Be sure to lubricate the gasket for time adjusting buttons if they are disassembled and before reassembling.

Remarks for disassembling and reassembling

⑧ How to set the speaker lead terminal B

Set the speaker lead terminal B to the battery guard as shown in the illustration on the right. Handle the speaker lead terminals A and B so as not to deform them.

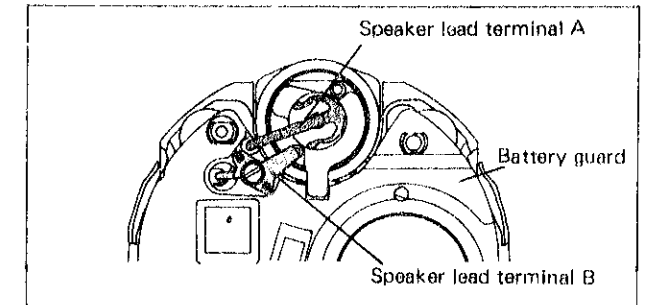

⑩ How to disassemble the module

- Disassembling
Hold the battery guard with tweezers and pull out the module toward you so as not to deform the tip (arrow-marked portion) of the speaker lead terminal A.
- Reassembling
When the protrusion of the center pole unit of the speaker block is out of the notch of the battery guard, set it in position by turning it with tweezers.

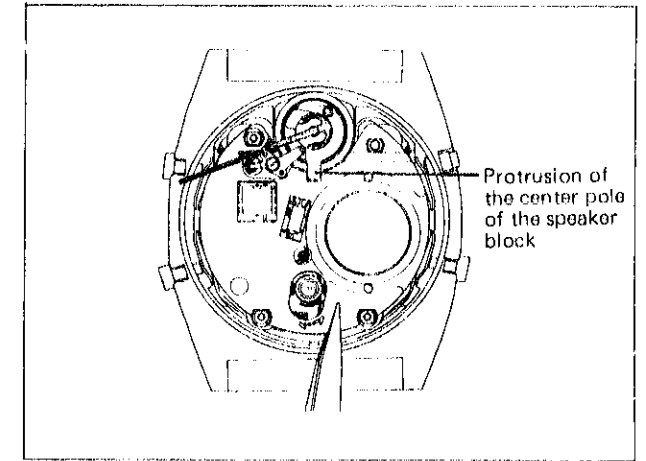

⑪ Speaker block

- As the speaker block is fixed to the casebezel, disassemble it by inserting the tips of tweezers under it and lifting it up.
- When holding and lifting up the protrusion of the pole unit of the speaker block with tweezers, it may occur that only the center pole unit of the speaker is removed. In this case, set the speaker block so that dust may not enter inside.
- When the vibrating plate or sound diaphragm is deformed, it may cause the tone or volume of the alarm to change. Be sure to handle it carefully.

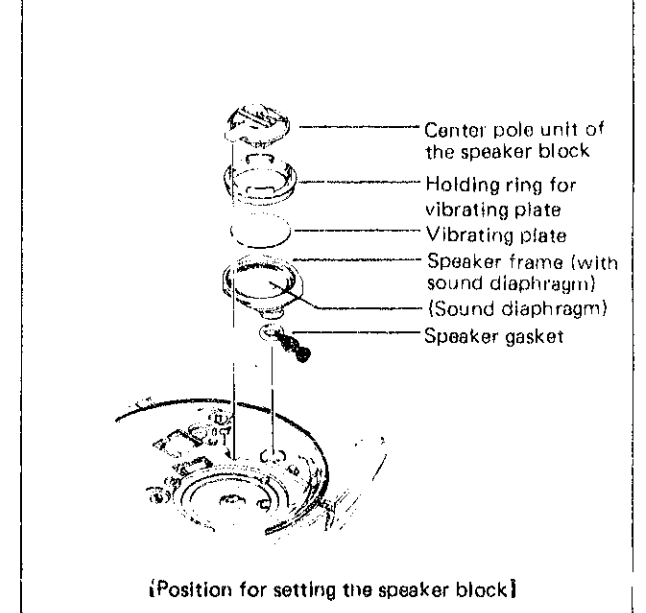
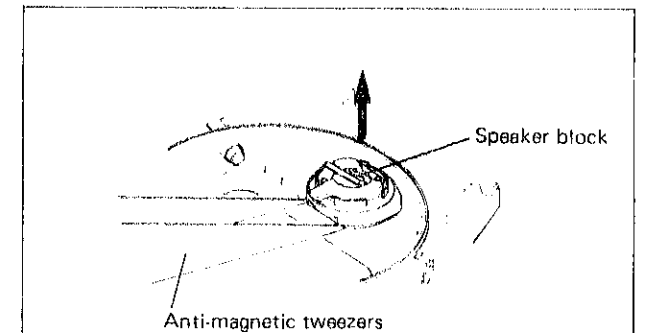

V. DISASSEMBLING AND REASSEMBLING OF THE MODULE

Disassembling procedures Figs.: ① → ⑱

Reassembling procedures Figs.: ⑱ → ①

- Use the module holder S-645 for disassembling and reassembling.

1. Liquid crystal panel side

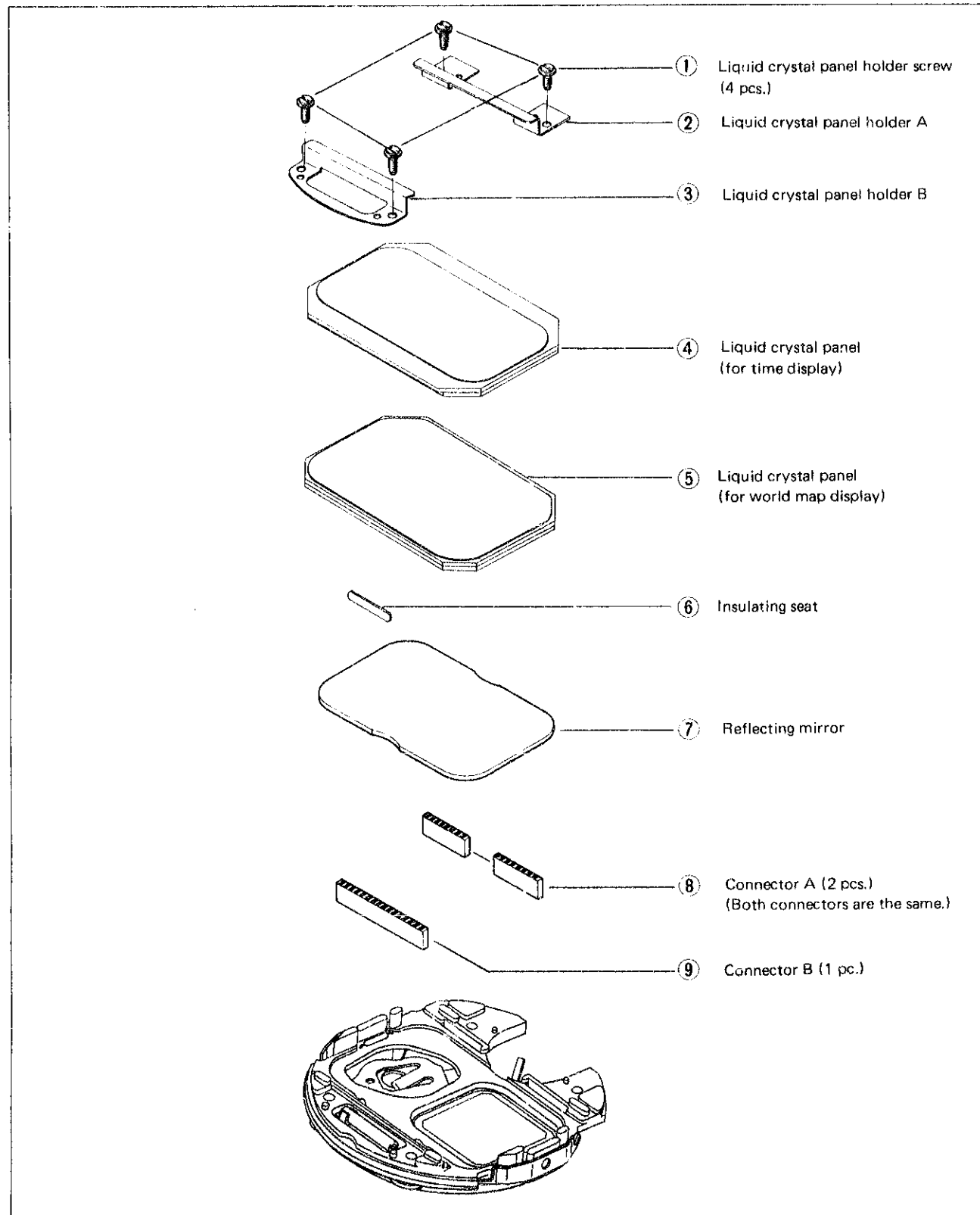

Remarks for disassembling and reassembling

④ ⑤ Liquid crystal panel

Be sure to handle the liquid crystal panel with a fingercot. Be careful not to push hard the surface of the liquid crystal panel with a finger.

Be sure to reassemble the liquid crystal panel to the liquid crystal panel frame.

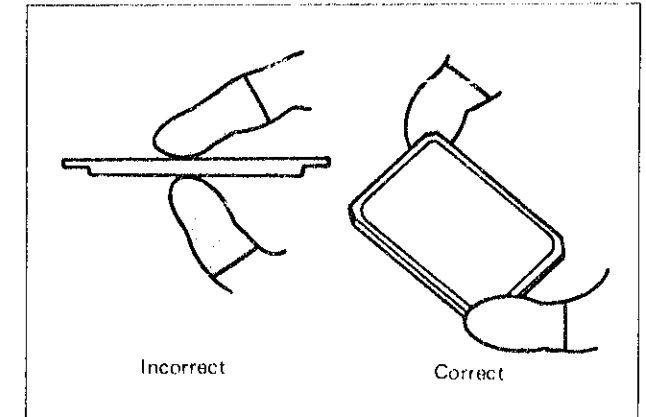

⑥ Insulating seat

Set it between the liquid crystal panel (for world map display) and the liquid crystal panel frame.

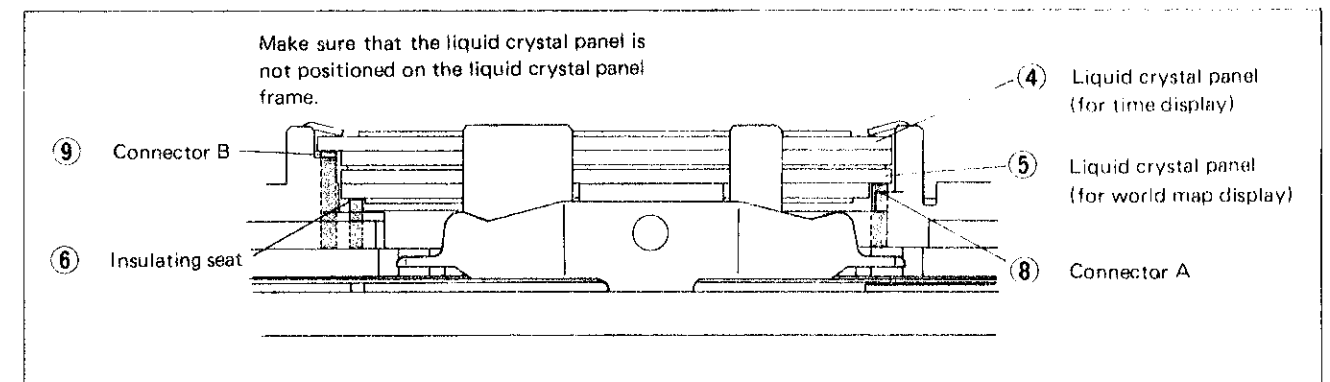
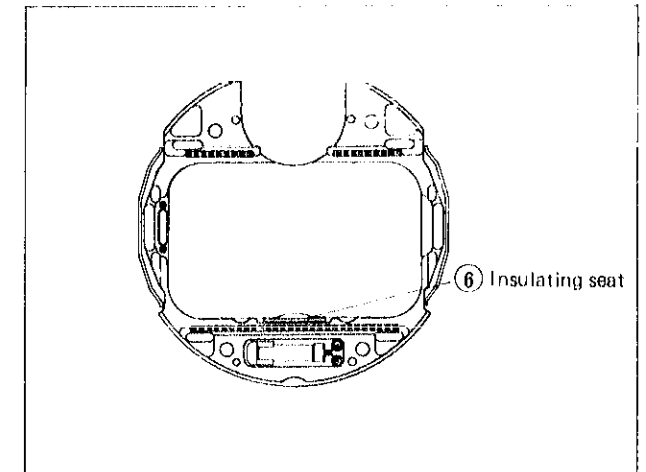

The liquid crystal panel (for time display) and the panel (for world map display) are positioned as shown in the illustration above in relation to the connectors A and B and the insulating seat.

⑦ Reflecting mirror

Be sure to handle the reflecting mirror with a fingercot. When it is handled with tweezers, it may cause the surface to be scratched.

⑧ ⑨ Connector A, B

There are used 3 connectors. The black portions are conductive. Check to see if there is any scratch, contamination, dust or lint.

2. Switch mechanism

(Bulb)

It is not necessary to disassemble the bulb except when it is replaced.

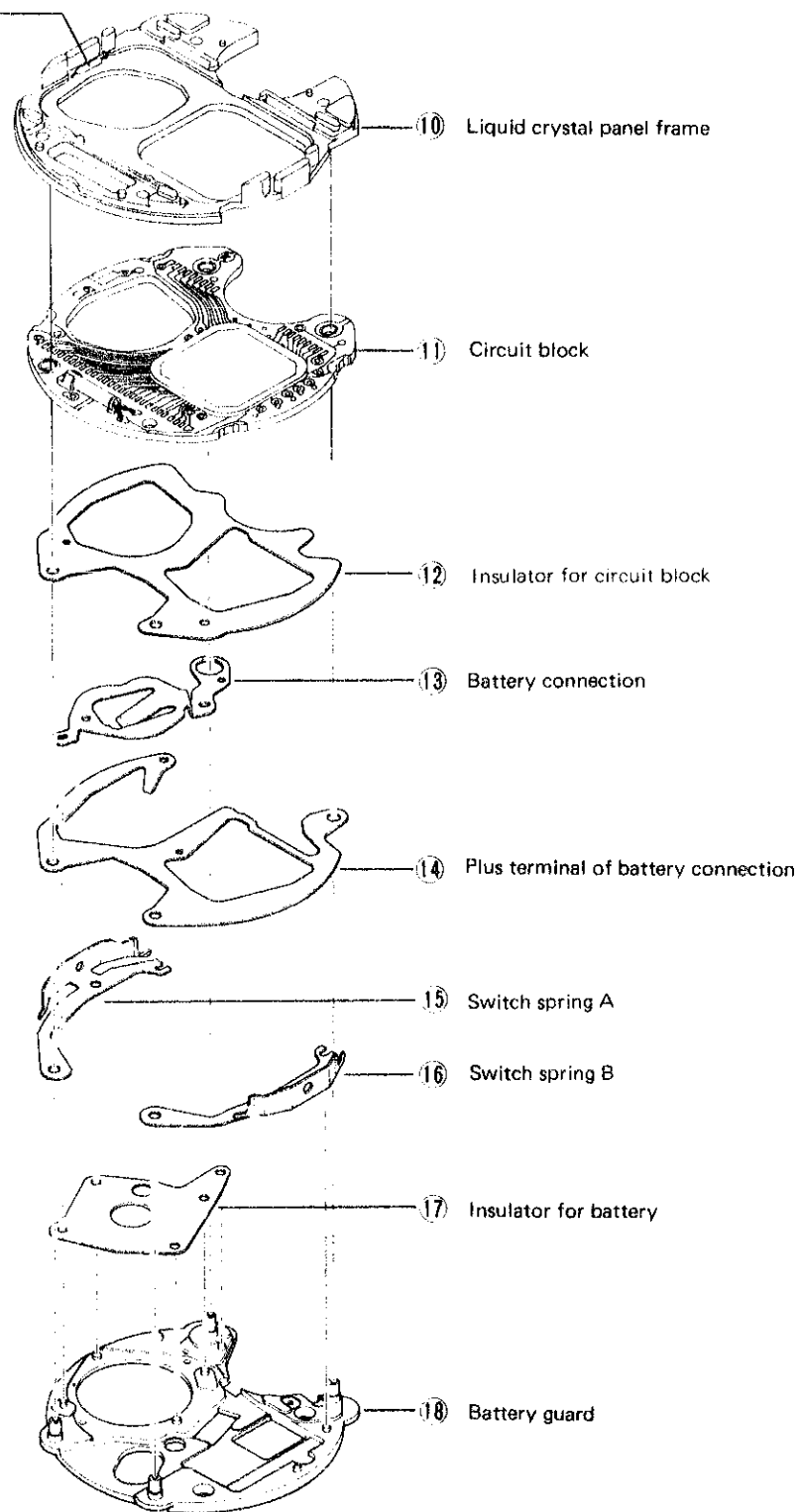

Remarks for disassembling and reassembling

10 Liquid crystal panel frame

When the bulb is reassembled to the liquid crystal panel frame, bend the bulb lead terminals correctly and set them in position as shown in the illustration on the right.

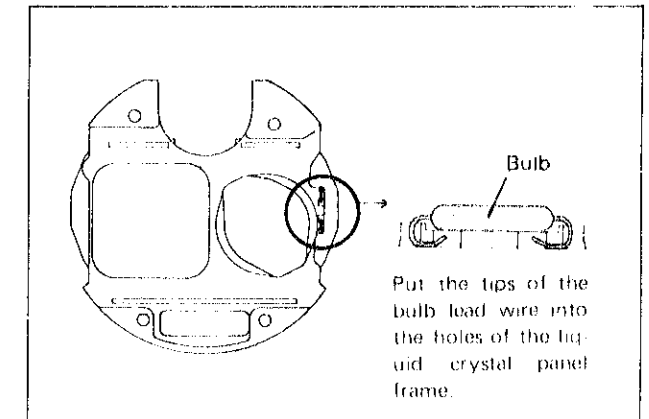

14 Plus terminal of battery connection

The plus terminal of the battery connection is thin. Be sure to handle it so as not to deform it.

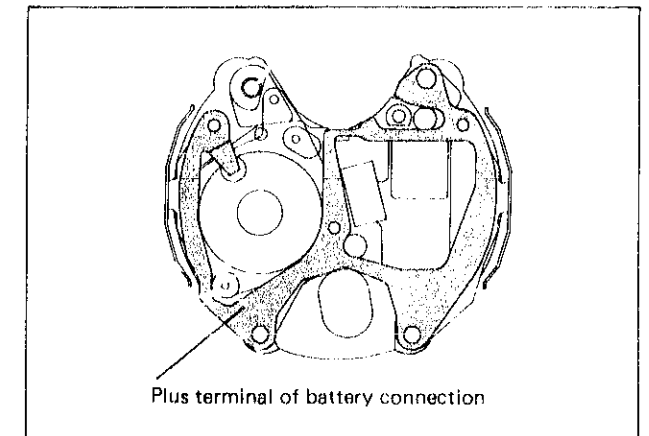

15 16 Switch spring A, B

Reassemble the switch springs A and B to the battery guard as shown in the illustration on the right. Be careful not to mistake the front for the back. The switch components are on the front side (upper side).

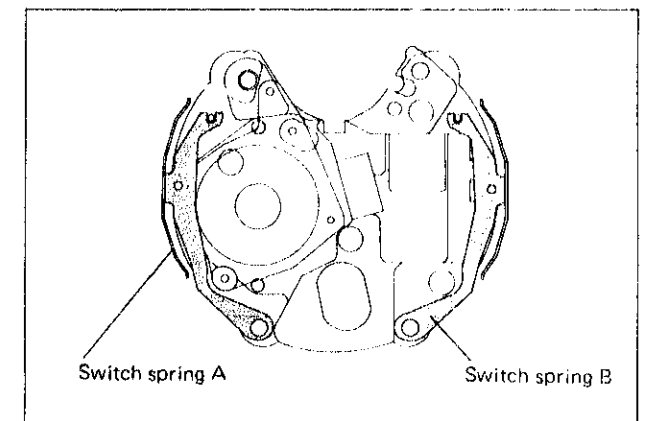

17 Insulator for battery

Reassemble the insulator for battery to the battery guard as shown in the illustration on the right.

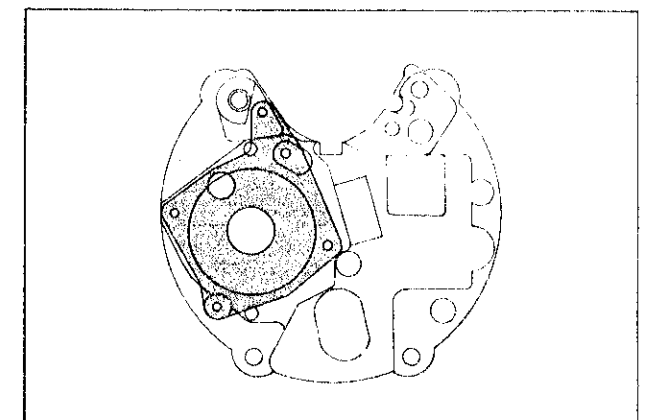

3. Segment (Liquid crystal panel electrode)

Liquid crystal panel (for time display) electrode

• Designation of segment

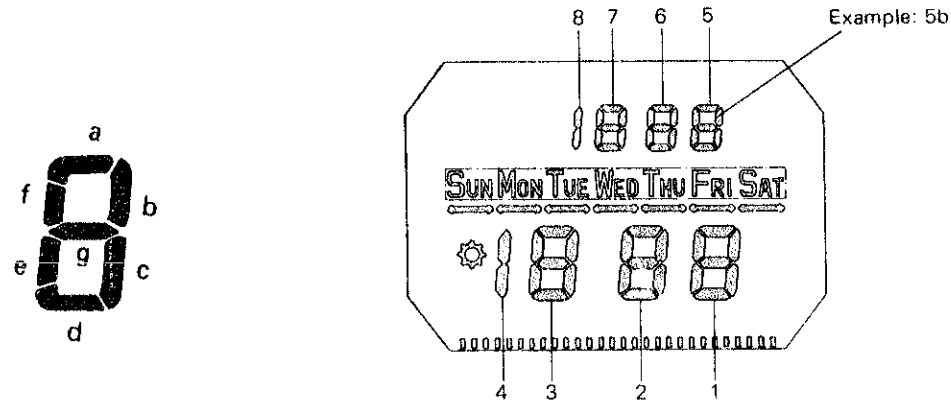

Common electrode 1 (electrically connected with segments)
Common electrode 2 (electrically connected with segments)

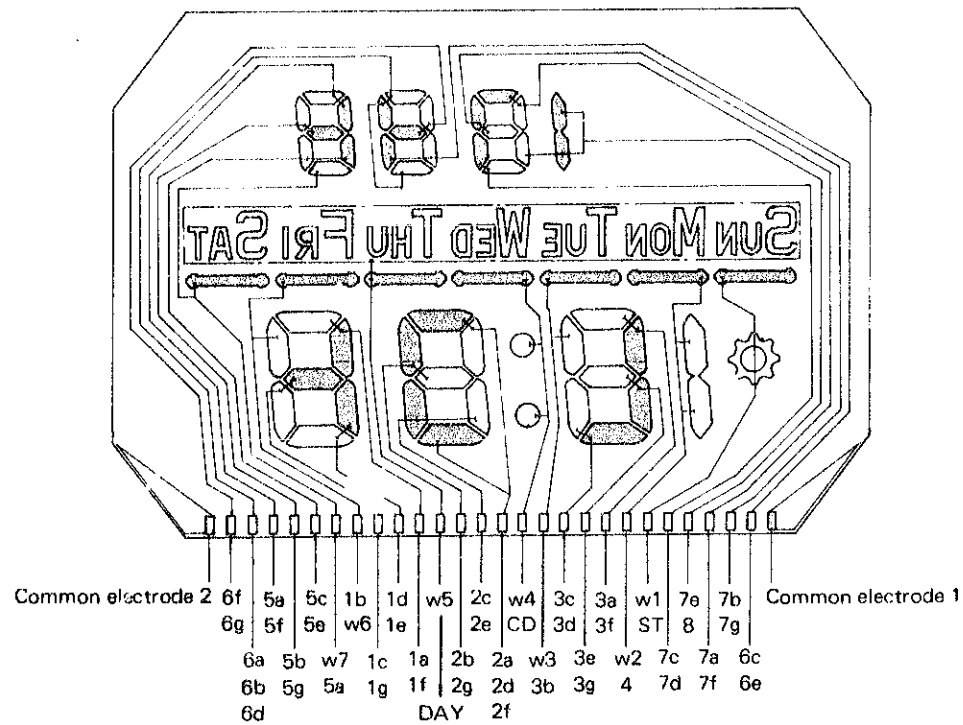

Liquid crystal panel (for world map display) electrode

Common electrode 1 (electrically connected with segments)
Common electrode 2 (electrically connected with segments)

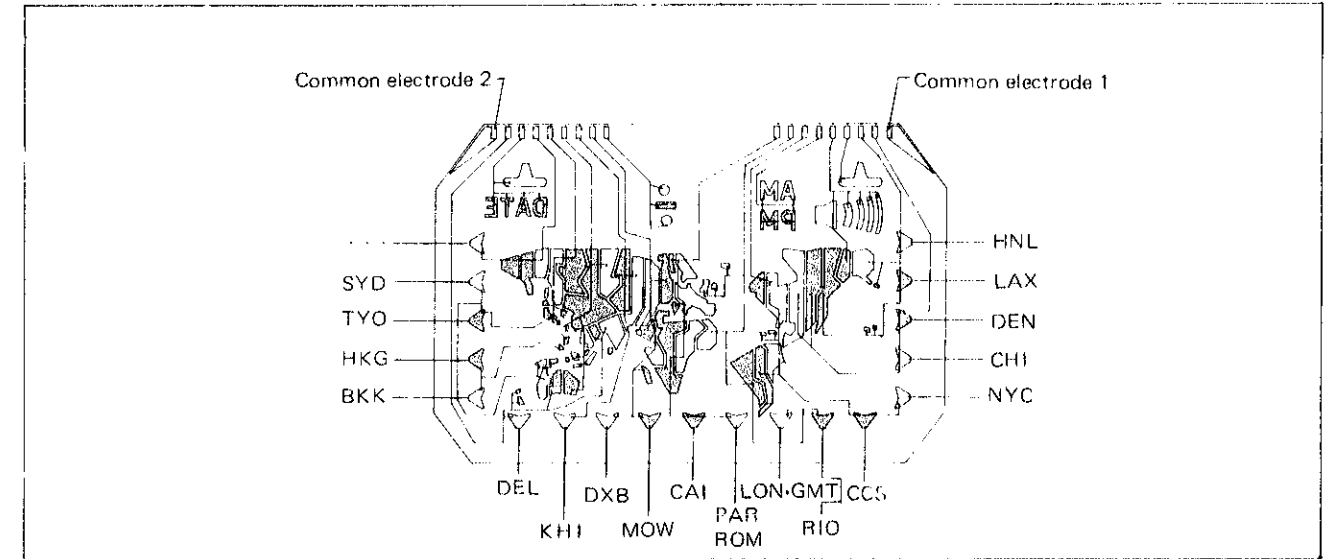

• Table of time differential among cities

(GMT) = Greenwich mean time; (+) = Gain over GMT
(-) = Loss from GMT

Loss/Gain (hour) from GMT	Name of city	City code (abbr. of city name)	Summer time (daylight saving time)	Other cities (for reference)
0	LONDON	LON (GMT)	Used	CASABLANCA, DAKAR
+ 1	PARIS ROME	PAR ROM	Used	BERLIN, AMSTERDAM
+ 2	CAIRO	CAI		ATHENS, ISTANBUL
+ 3	MOSCOW	MOW		KIEV, NAIROBI, MECCA
+ 4	DUBAI	DXB		
+ 5	KARACHI	KHI		
+ 5½	DELHI	DEL		CALCUTTA, BOMBAY
+ 7	BANGKOK	BKK		PHNON-PENH, JAKARTA
+ 8	HONG KONG	HKG	Used	PEKING, MANILA
+ 9	TOKYO	TYO		SEOUL
+ 10	SYDNEY	SYD	Used	KHABAROVSK, GUAM
+ 11				NOUMEA (NEW CALEDONIA) SOLOMON ISLS.
- 10	HONOLULU	HNL		ANCHORAGE
- 8	LOS ANGELES	LAX	Used	SAN FRANCISCO
- 7	DENVER	DEN	Used	EDMONTON (CANADA)
- 6	CHICAGO	CHI	Used	HOUSTON, MEXICO
- 5	NEW YORK	NYC	Used	WASHINGTON D.C. MONTREAL
- 4	CARACAS	CCS		SANTIAGO (CHILE)
- 3	RIO DE JANEIRO	RIO		BUENOS AIRES

VI. CHECKING AND ADJUSTMENT

Refer to the "SEIKO QUARTZ TECHNICAL GUIDE, GENERAL INSTRUCTION FOR DIGITAL WATCHES" for details.

Procedures

CHECK BATTERY VOLTAGE

- Time setting operation when checking the battery voltage or the battery is replaced

Cal. A239A may occasionally display wrong time when the battery voltage is checked or the battery is replaced. In that case, the correction of figures of time display of the home time alarm and world time alarm may also become impossible.

After checking the battery voltage and replacing the battery, be sure to depress the four buttons (A), (B), (C) and (D) at the same time before setting the time.

When the four buttons are depressed together, check to see if the display is given as specified below:

[In the home time display]

Alarm time : 1:00 A.M.
Time : 12:00 A.M.
Day : SUNDAY
Date : 1st of January

[In the world time display]

Alarm time : 1:00 A.M.
Time : 12:00 A.M.
Time zone : HONOLULU (HNL)

- The caution, attached on the inside of the battery hatch of Cal. A239A, requires the operations above should be performed after battery replacement. Be sure to observe the instruction.



CHECK PATTERN SEGMENT CHECKING SYSTEM

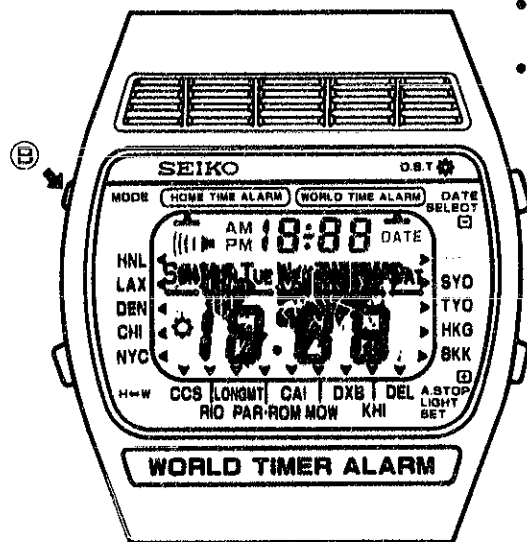

- Depress and hold button (B) for 3 to 4 seconds, and all the segments light up.
- With all the segments lit, check to see if there is any defective segment.

CHECK CONDUCTIVITY OF LIQUID CRYSTAL PANEL, CIRCUIT BLOCK AND CONNECTORS

Procedures

CHECK LIQUID CRYSTAL PANEL AND CIRCUIT BLOCK

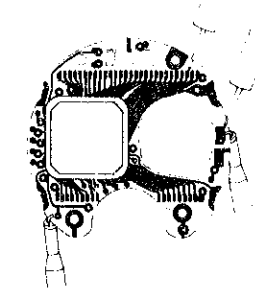

Current supplier (S-833)

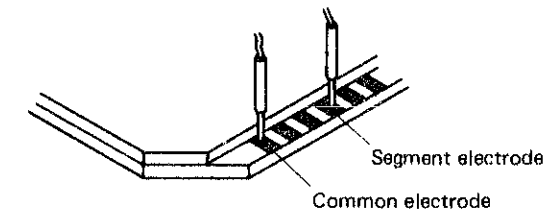

- Check to see if the electric signal flows into the liquid crystal panel from the circuit block.

Result:

More than 0.8V → Normal
Less than 0.8V → Defective
Replace the circuit block.

- Check to see if there are any broken wire, short circuit, etc. in the liquid crystal panel.

Result:

Lights up → Normal
Does not light up → Defective
Replace the liquid crystal panel.

CHECK CURRENT CONSUMPTION

- Set up the Volt-ohm-meter.
Probe Red (+) :
Battery connection (-)
Probe Black (-):
Battery surface (-)

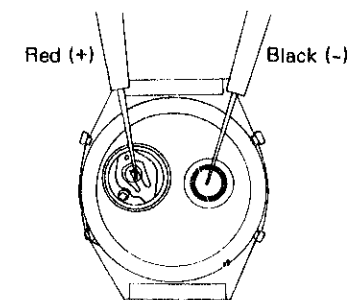

Result:

Less than 4.5 μ A → Normal
More than 4.5 μ A → Defective

* Replace the liquid crystal panel or the circuit block.

- How to find the defective portion when the current consumption is large.

Disassembling of the case
Remove the liquid crystal panel from the module after tightening the liquid crystal panel holder screws (4 pcs.).

Result:

Less than 3.6 μ A:
Circuit block → Normal
Replace the liquid crystal panel.

More than 3.6 μ A:
Circuit block → Defective
Replace the circuit block.

As Cal. A239A uses a special IC, the pointer of the Volt-ohm-meter swings unstably when measuring the current consumption. Check the current consumption with the condenser kit (S-904) connected and read the intermediate value.

Procedures

CHECK ACCURACY

Light up all the segments, and the daily rate can be measured more easily.

CHECK FUNCTIONING AND ADJUSTMENT

Measure the internal coil resistance of the speaker block and check to see if there are any broken wire and short circuit.

1. Set up the Volt-ohm-meter.
Range to be used: OHMS R x 1

2. Checking
Apply the probes of the Volt-ohm-meter to the two pin heads of speaker lead terminal on the insulator for speaker block.

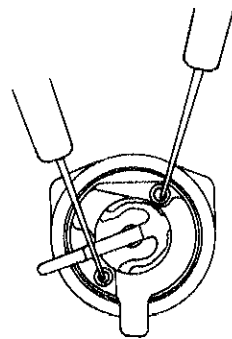

Result:
Resistance is:
 $120\Omega \sim 140\Omega \rightarrow$ Normal

Less than 120Ω
(Short circuit)
More than 140Ω
(Broken wire) } Defective

Replace the speaker block.

CHECK CONDUCTIVITY OF SWITCH COMPONENTS

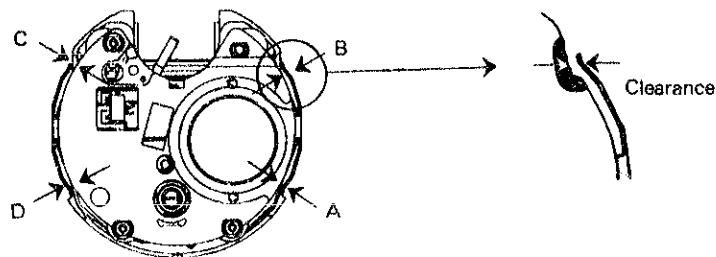

1. Check to see if when the switch springs A, B, C and D are pushed with tweezers, each of them touches the circuit block electrode and to see if there is a clearance about twice the width of the switch spring when released.
2. Check to see if there are any dust, lint and contamination on the conductive portions above.

Result:
Functions correctly \rightarrow Normal

Does not function correctly
 \rightarrow Defective

Replace the switch spring
when not adjustable.

All procedures of Disassembling, Reassembling, Checking and Adjustment are completed.