

# **SEIKO LASSALE**









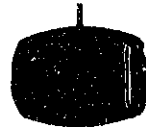
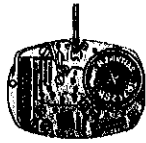

















**QUARTZ**





**Cal. 6730A**

# **PARTS CATALOGUE**

# Cal. 6730A



					
125 277	231 272	241 272	261 272	☆ 270 182	☆ 271 182
					
281 272	282 271	☆ 351 085	☆ 351 087	☆ 351 089	☆ 351 091
					
383 271	384 271	388 271	391 271	391 471	491 271
					
701 272	4001 279	4002 272	4146 272	4219 274	4219 275
					
4219 276	4239 272	4270 272	4271 271	4408 271	☆ SEIKO TR712SW

				
012 155	012 180	012 181	012 182	$\frac{2}{1}$

☆⇒ Please see remarks on the next reverse page.

# Cal. 6730A

## Characteristics

Casing diameter : 18.0 × 13.0 mm  
 Maximum height : 1.1 mm  
 Jewels : 14 j  
 Frequency of quartz crystal oscillator : 32,768 Hz (Hz=Hertz . . . . Cycles per second)  
 Driving system : Step motor (2 poles)  
 Regulation system : Chip condenser  
 Train wheel setting

PART NO.	PART NAME	PART NO.	PART NAME
<b>125 277</b>	Train wheel bridge	011 563	Upper hole jewel for minute wheel
<b>231 272</b>	Third wheel & pinion	011 564	Upper hole jewel for setting wheel
<b>241 272</b>	Fourth wheel & pinion	011 565	Lower hole jewel for setting wheel
<b>261 272</b>	Minute wheel	011 566	Upper hole jewel for step rotor
☆ <b>270 182</b>	Center minute wheel with cannon pinion (1.53 mm)	011 566	Lower hole jewel for step rotor
☆270 183	Center minute wheel with cannon pinion (1.83 mm)	011 567	Lower hole jewel for minute wheel
☆270 184	Center minute wheel with cannon pinion (1.53 mm)	011 737	Lower hole jewel for center wheel
☆270 185	Center minute wheel with cannon pinion (1.83 mm)	<b>012 155</b>	Dial screw
☆270 188	Center minute wheel with cannon pinion (2.48 mm)	<b>012 180</b>	Train wheel bridge screw
☆ <b>271 182</b>	Hour wheel (0.70 mm)	<b>012 181</b>	Yoke spring holder screw
☆271 183	Hour wheel (0.90 mm)	<b>012 182</b>	Coil block screw
☆271 188	Hour wheel (1.55 mm)	<b>012 182</b>	Circuit block screw
<b>281 272</b>	Setting wheel	☆SEIKO TR712SW	Silver (II) oxide battery
<b>282 271</b>	Clutch wheel		
☆ <b>351 085</b>	Winding stem		
☆ <b>351 087</b>			
☆ <b>351 089</b>			
☆ <b>351 091</b>			
<b>383 271</b>	Setting lever		
<b>384 271</b>	Yoke (Clutch lever)		
<b>388 271</b>	Setting lever spring		
<b>391 271</b>	Train wheel setting lever A		
<b>391 471</b>	Train wheel setting lever B		
<b>491 271</b>	Dial washer		
<b>701 272</b>	Fifth wheel & pinion		
<b>4001 279</b>	Circuit block		
<b>4002 272</b>	Coil block		
<b>4146 272</b>	Step rotor		
<b>4219 274</b>	Battery connection insulator A		
<b>4219 275</b>	Battery connection insulator B		
<b>4219 276</b>	Battery connection insulator C		
<b>4239 272</b>	Rotor stator		
<b>4270 272</b>	Battery connection (—)		
<b>4271 271</b>	Battery connection (+)		
<b>4408 271</b>	Spacer for center minute wheel		
011 561	Upper hole jewel for center wheel		
011 562	Upper hole jewel for third wheel		
011 562	Lower hole jewel for third wheel		
011 562	Upper hole jewel for fourth wheel		
011 562	Lower hole jewel for fourth wheel		
011 562	Upper hole jewel for fifth wheel		
011 562	Lower hole jewel for fifth wheel		

☆ ⇨ Please see remarks on the reverse page.  
 Part numbers in light letters are not shown in photos.









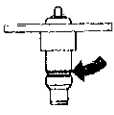

# Cal. 6730A

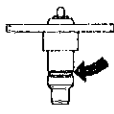
## Remarks :

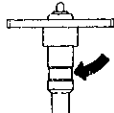
### Center minute wheel with cannon pinion, Hour wheel

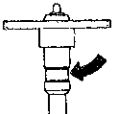
There are five different types of Center minute wheel with cannon pinion and three different types of Hour wheel as specified below.

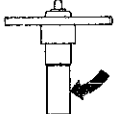
Combination :

Type	Center minute wheel with cannon pinion	Hour wheel
a	 ☆270 182 (Gold plated)	 ☆271 182
b	 ☆270 184	 ☆271 182
c	 ☆270 183 (Gold plated)	 ☆271 183
d	 ☆270 185	 ☆271 183
e	 ☆270 188	 ☆271 188

### Winding stem

☆351 085  
 ☆351 087  
 ☆351 089  
 ☆351 091

.....Refer to the photograph on the front page.

If the combination of the winding stem and case is unknown, check the case number and refer to "SEIKO LASSALE Quartz Casing Parts Catalogue" to choose a corresponding winding stem.

### Battery

☆ SEIKO TR712SW.....Note that SEIKO battery is marked with "SEIZAIKEN" on its (+) side.

# TECHNICAL GUIDE

## SEIKO LASSALE

QUARTZ

CAL. 6730A

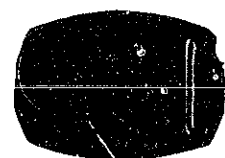

### CONTENTS

I. SPECIFICATIONS .....	1
II. STRUCTURE OF THE CIRCUIT BLOCK .....	1
III. DISASSEMBLING AND REASSEMBLING OF THE CASE .....	2
IV. DISASSEMBLING, REASSEMBLING AND LUBRICATING .....	4
1. Indicating mechanism .....	4
2. Electronic circuit .....	7
3. Gear train mechanism .....	8
4. Setting mechanism .....	9
V. CHECKING AND ADJUSTMENT .....	10
• Check output signal .....	10
• Check battery voltage .....	10
• Check battery conductivity .....	10
• Check circuit block conductivity .....	10
• Check reset and train wheel setting conditions .....	10
• Check coil block .....	10
• Check accuracy .....	12
• Check current consumption .....	12

## I. SPECIFICATIONS

Cal. No.	6730A
Item	
Time indication	2 hands time indication (moves at every 20 seconds)
Additional mechanism	Electronic circuit reset switch Train wheel setting device
Loss/gain	Loss/gain at normal temperature range Monthly rate : less than 15 seconds (Annual rate : less than 3 minutes)
Movement size	φ18.5mm
Casing diameter	φ18.2mm (18.0mm between 6 o'clock and 12 o'clock sides; 13.0mm between 3 o'clock and 9 o'clock sides)
Height	1.1mm without battery
Regulation system	Chip condenser
Measuring gate by Quartz Tester	The gate of 10 seconds is available.
Battery	SEIKO (SEIZAIKEN) TR712SW Battery life is approximately 2 years. Voltage: 1.55V
Jewels	14 jewels

## II. STRUCTURE OF THE CIRCUIT BLOCK

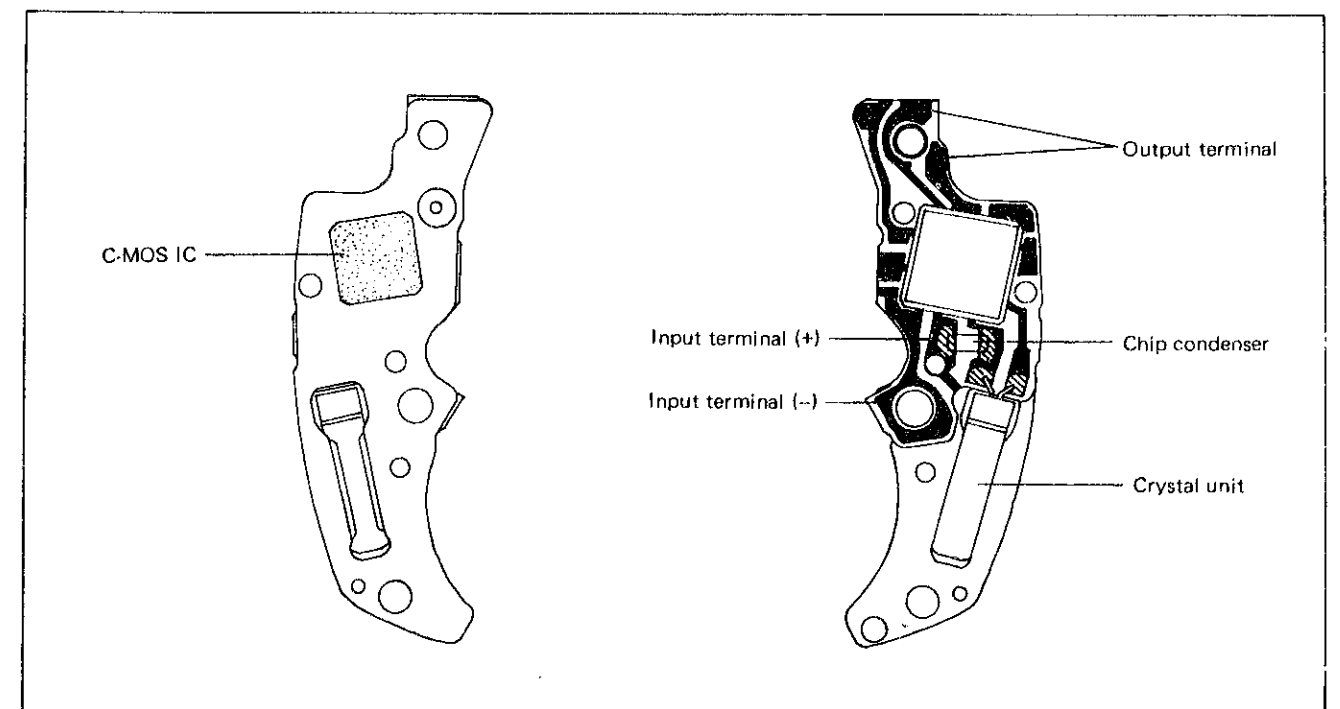

### III. DISASSEMBLING AND REASSEMBLING OF THE CASE

Disassembling procedures Figs.: ① ~ ⑧

Lubricating: Silicone grease 500,000 c.s.

Reassembling procedures Figs.: ⑧ ~ ①

Normal quantity ●▶

- Cal. 6730A uses the case back screw type and the snap type case back. The disassembling and reassembling of the case back screw type will be explained here.
- When disassembling and reassembling, be sure to use a screwdriver matching the diameter and groove of the screw.

Ex. Case No. 6730-5019  
(Case back screw type)

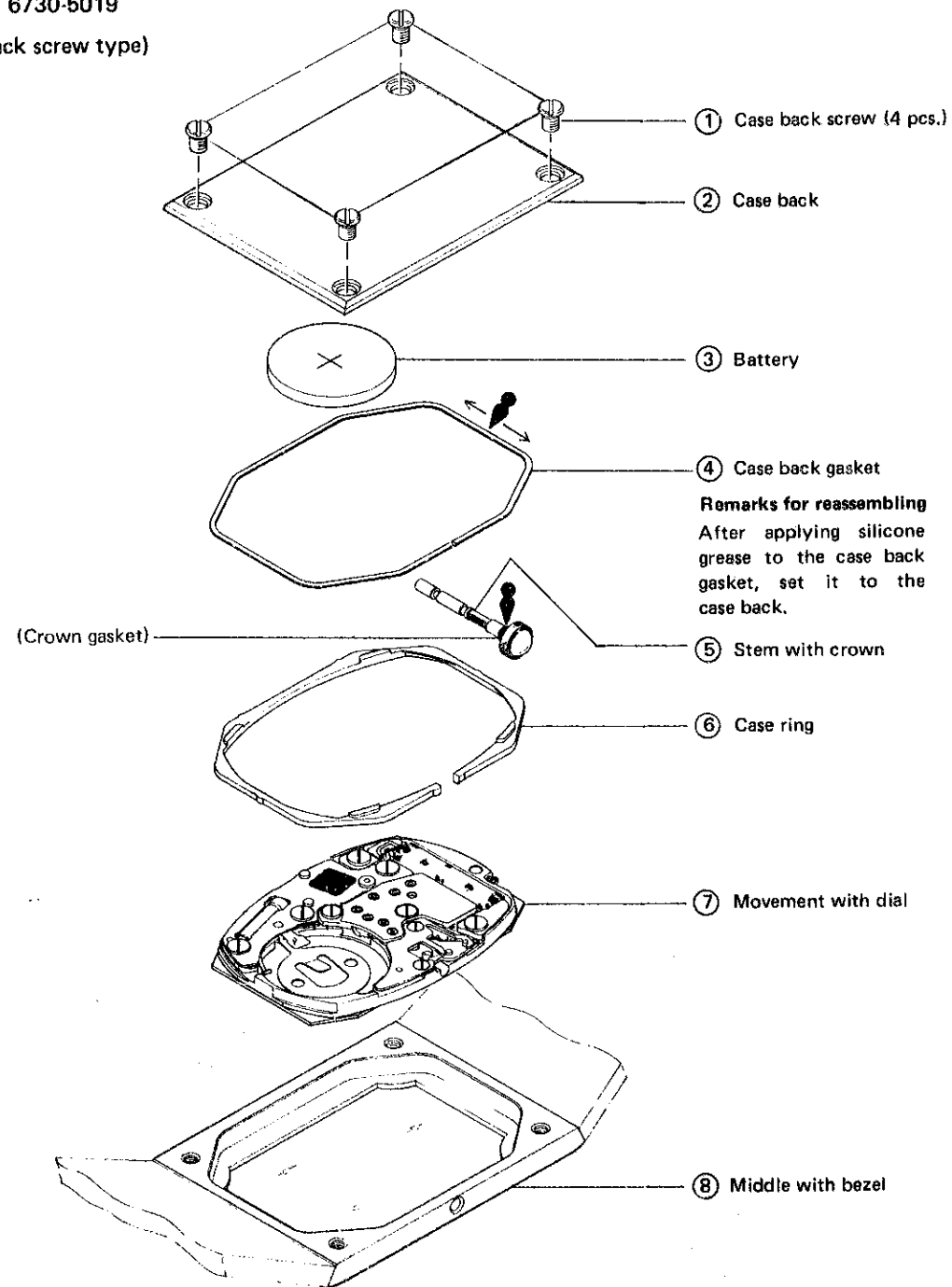

#### Remarks for disassembling and reassembling

##### ① Case back screw

- Be sure to tighten two by two the four screws which are positioned diagonally each other so that the clearance between the middle with bezel and the case back is equal.
- Hard tightening may cause a dent on the case back.

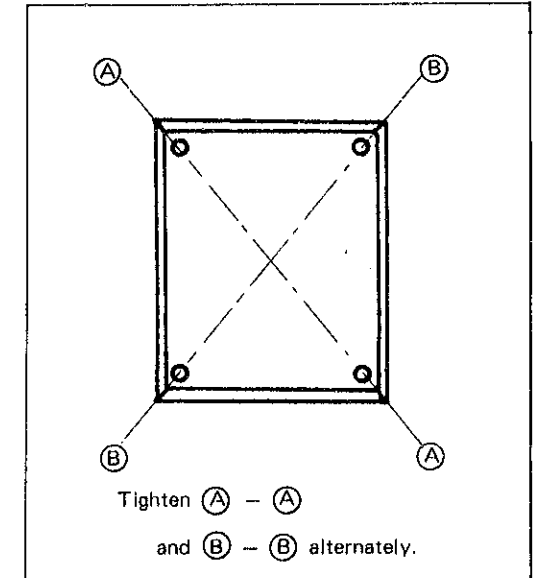

##### ⑤ Stem with crown

###### How to disassemble

- With crown at the normal position, push the tail of the setting lever (arrow-marked portion) and remove the stem with crown.
- When handling the stem with crown, be careful not to give it undue force in the transverse direction.

###### How to reassemble

- Push the tail of the setting lever with tweezers and push in the stem with crown gently while turning it lightly.

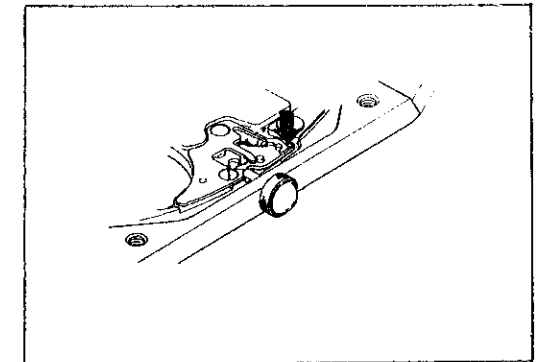

##### ⑦ Movement with dial

- After reassembling the movement with dial to the middle with bezel, set the winding stem while holding the movement with the finger so as not to move it.

#### IV. DISASSEMBLING, REASSEMBLING AND LUBRICATING

Disassembling procedures Figs.: ① ~ ③②

Reassembling procedures Figs.: ③② ~ ①

Lubricating:

Types of oil

Oil quantity

● Moebius A

○ Normal

○ SEIKO Watch Oil S-6

○ Extremely small

- Use the movement holder S-675 for disassembling and reassembling.

As the Cal. 6730A is a ultra thin watch, be sure to use the movement holder S-675 so that the main plate may not be deformed.

##### 1. Indicating mechanism

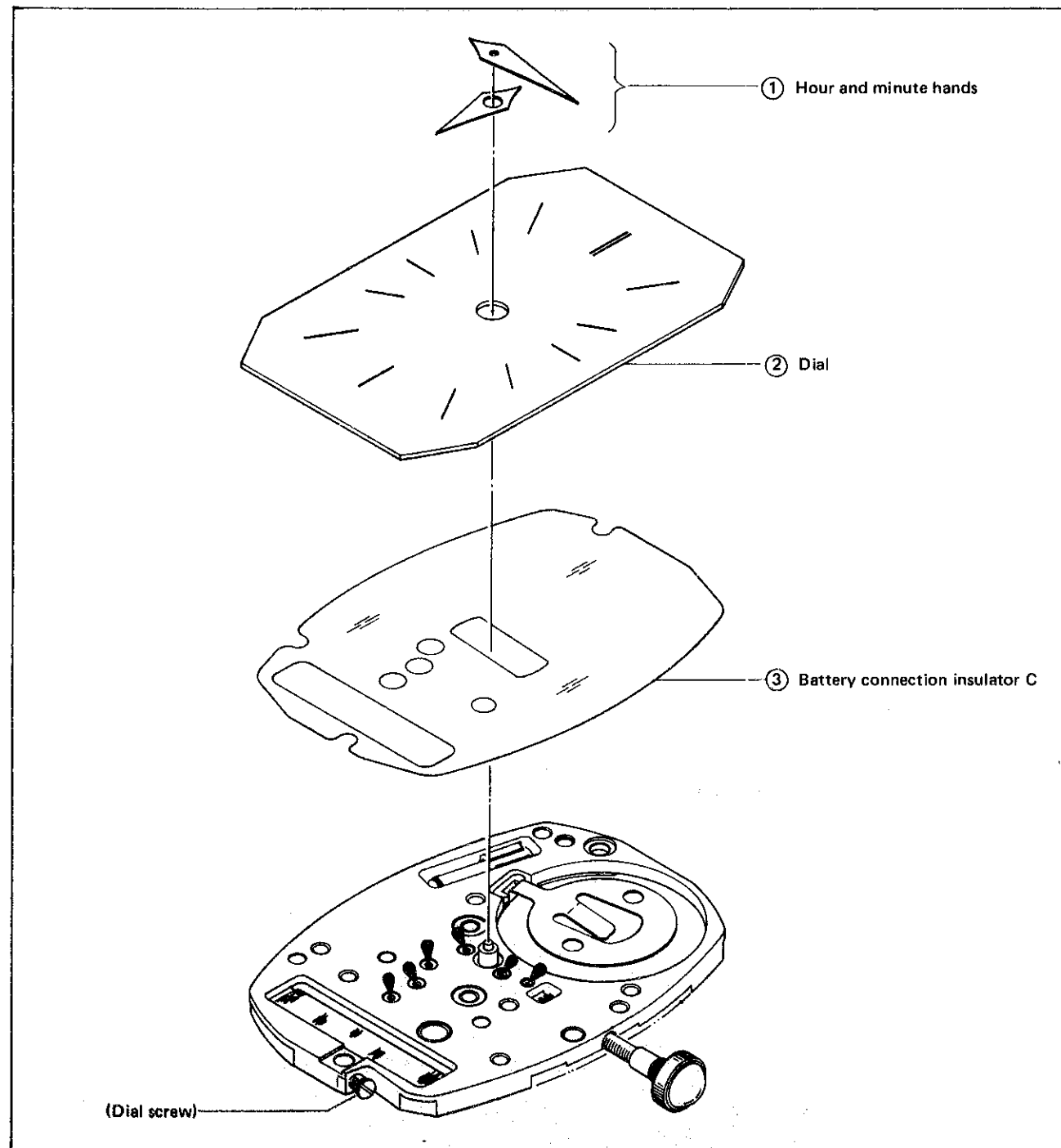

Remarks for disassembling and reassembling

##### ① Hour and minute hands

- How to disassemble the hour and minute hands

As this watch has only a little clearance between the dial and the hands, the bow-type hand remover cannot be used for some models. Disassemble the hands by following the instructions below.

1. Prepare a vinyl sheet and make a small hole in the center of it. (Ex: Use a vinyl bag for spare parts container)
2. Set the vinyl sheet so that the minute hand comes out from the hole of the vinyl sheet.
3. Hold the one end of the vinyl sheet with the finger and pull the other end up to disassemble the minute hand. When holding the vinyl sheet with the finger, be careful not to scratch the dial surface with the nail. Disassemble the hour hand following the same procedures.

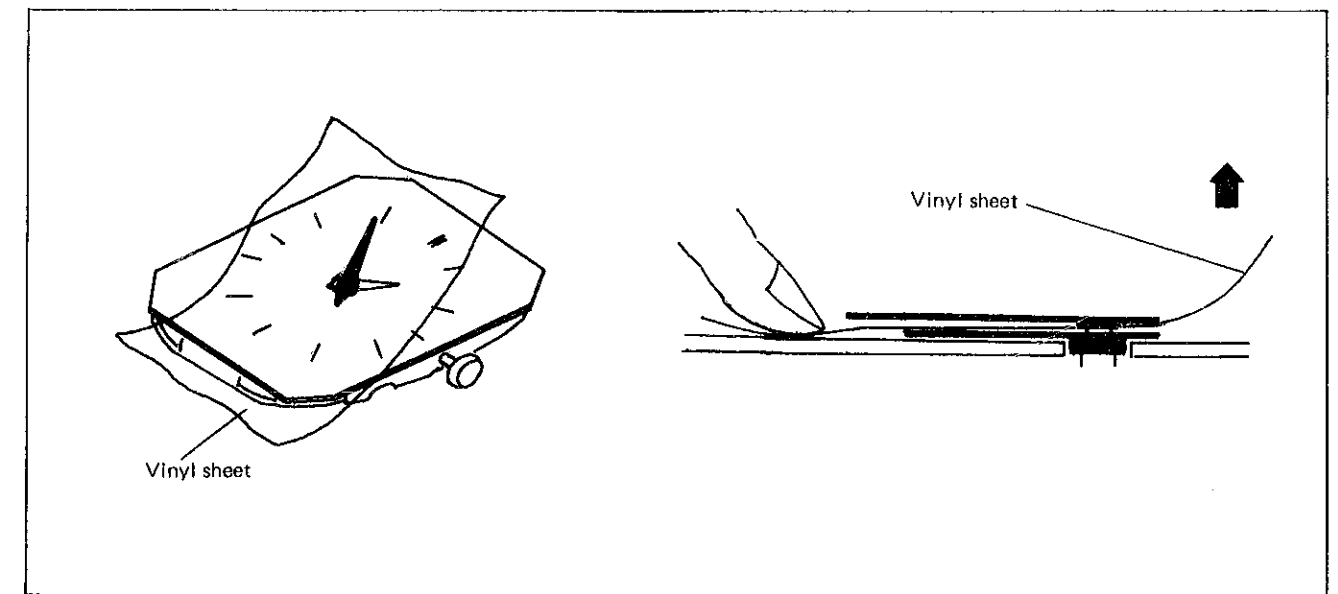

- How to reassemble the hour and minute hands

Use the movement holder S-675.

Place a vinyl sheet on the hands so as not to scratch them and push them in.

When pushing in the hands, be careful not to apply undue force on to the dial and the movement to deform them.

After having pushed in the hands, their setting condition cannot be adjusted. Be sure to push them in one by one so that they are set horizontally.



② Dial

The dial is fixed with the dial screw on 6 o'clock side, but the dial screw is not used on 12 o'clock side because it is held with the battery connection insulator A.

After setting the dial, check to see if it is set correctly level.

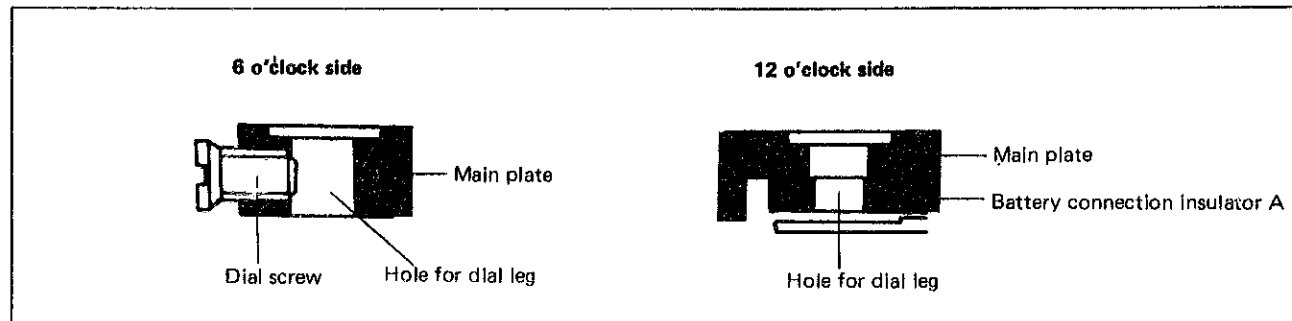

• List of screw used

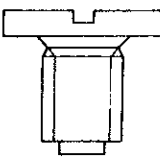
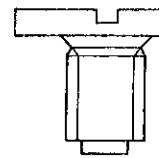
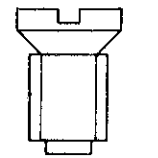
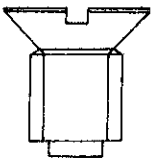
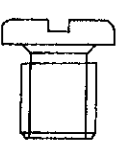
				
012 180	012 182	012 155	012 181	8150 3139
Train wheel bridge screw (2 pcs.)	Coil block screw (2 pcs.) Circuit block screw (3 pcs.)	Dial screw (1 pc.)	Setting lever spring screw (2 pcs.)	Case back screw (4 pcs.)

2. Electronic circuit

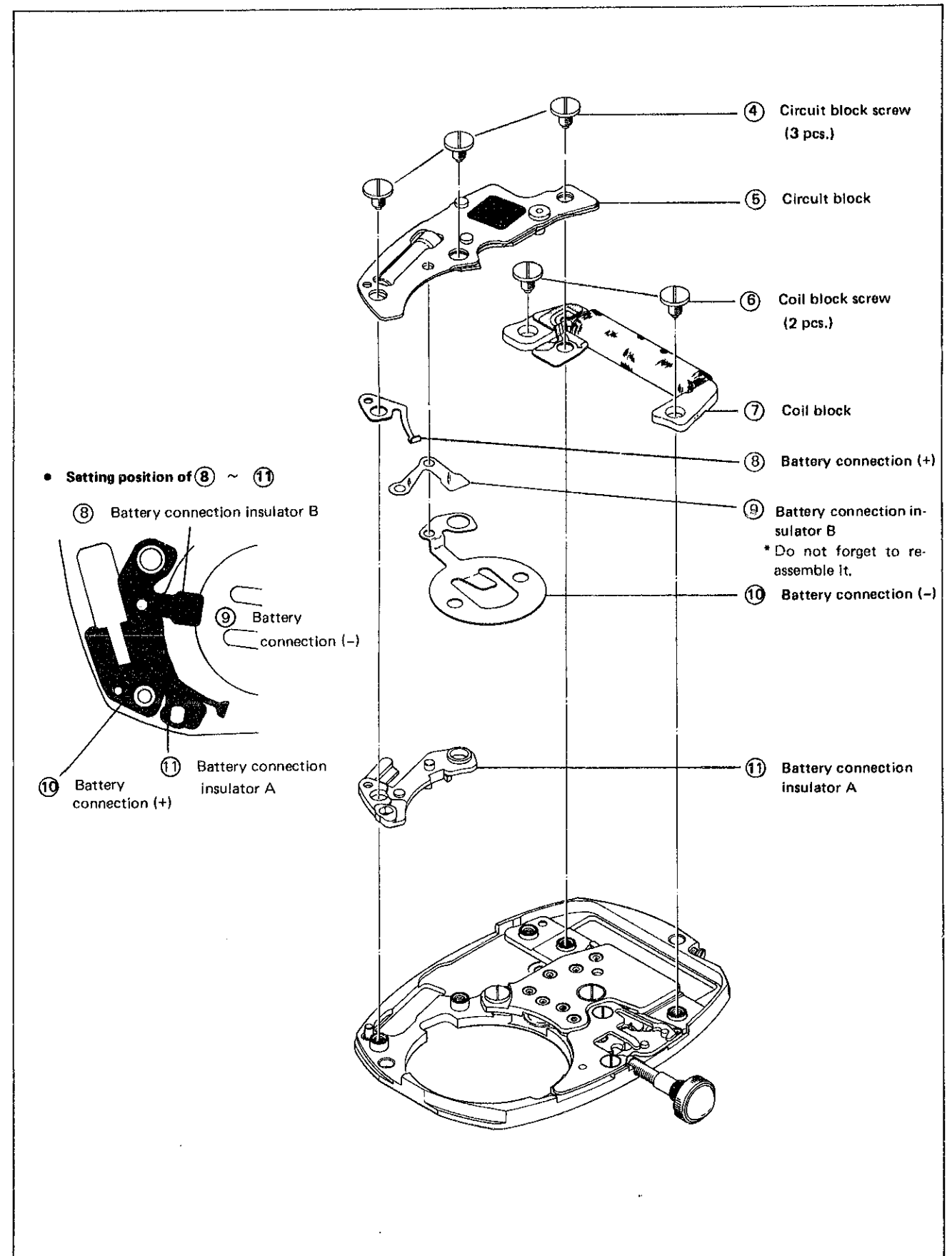

### 3. Gear train mechanism

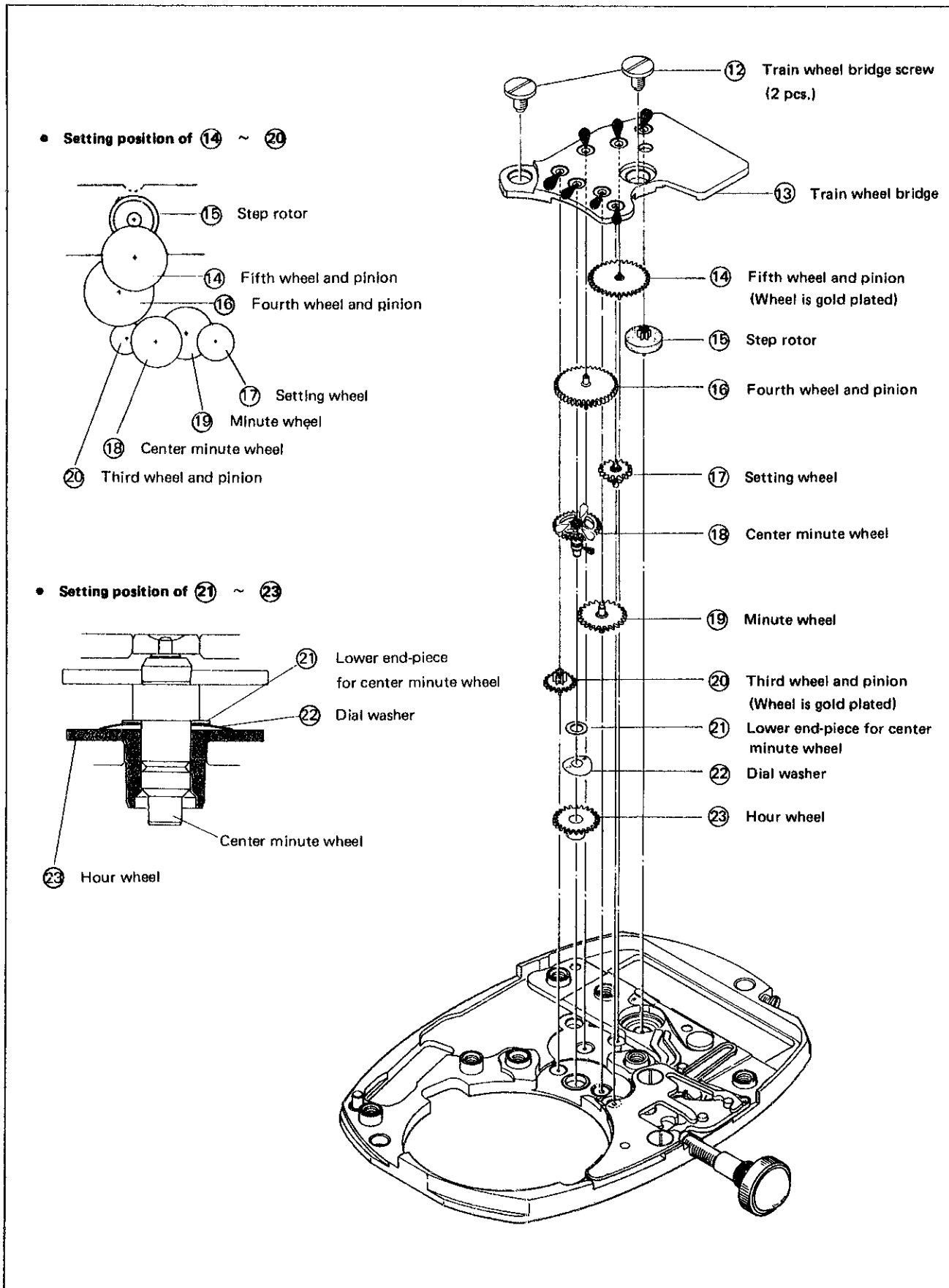

### 4. Setting mechanism

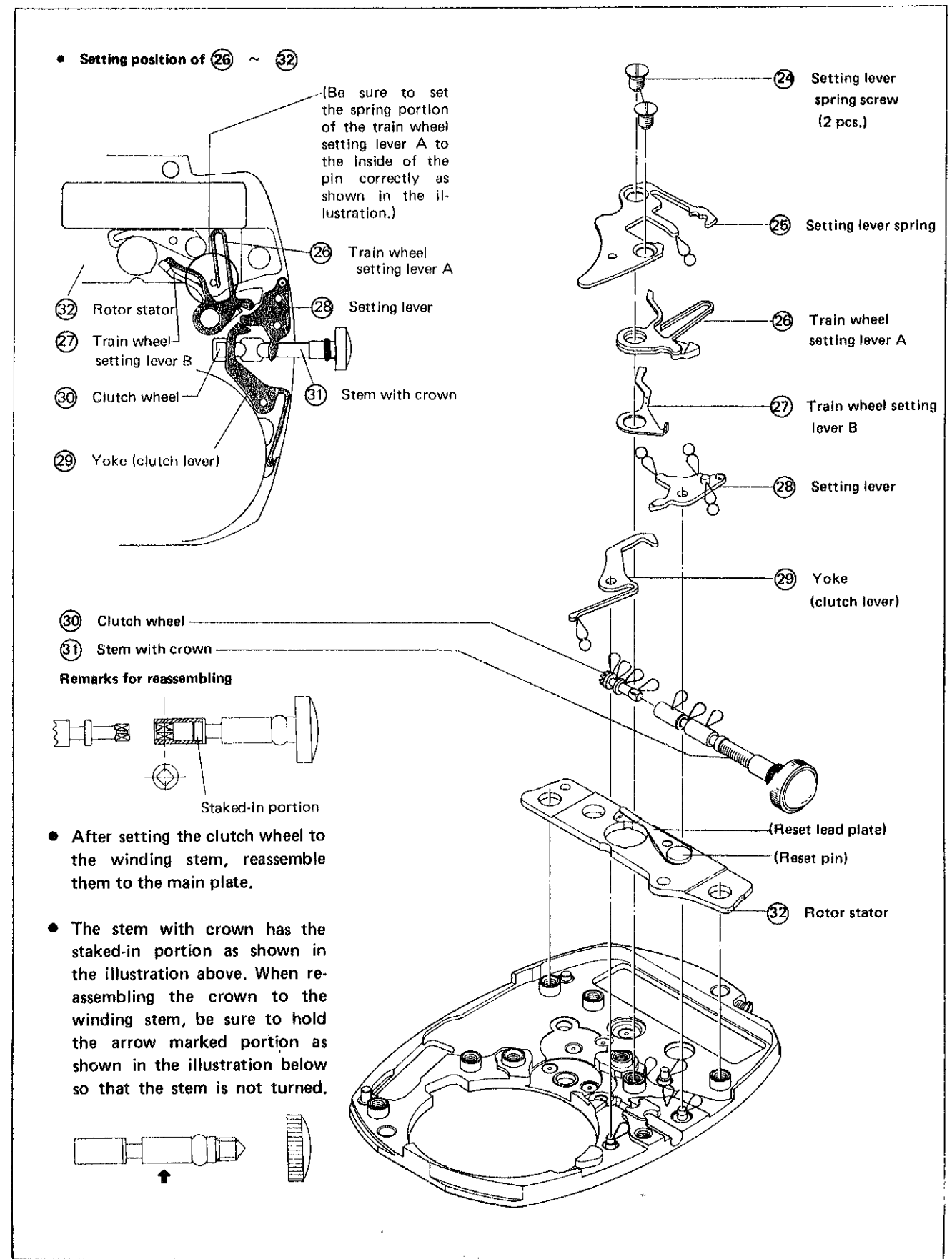

## V. CHECKING AND ADJUSTMENT

- Refer to the "SEIKO QUARTZ TECHNICAL GUIDE, GENERAL INSTRUCTION" for analogue watches for details.

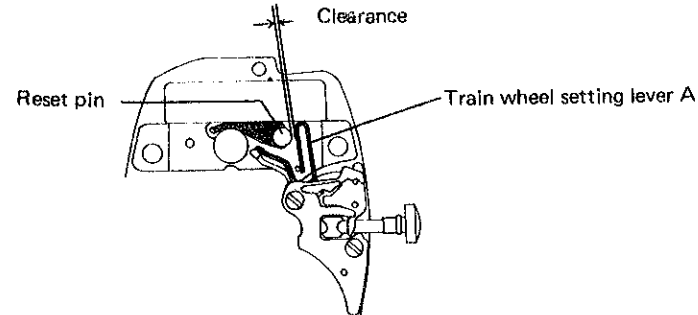
Procedure	
<b>CHECK OUTPUT SIGNAL</b>	
<ul style="list-style-type: none"> <li>Set the measuring gate of the Quartz Tester at 10 seconds. (Cal. 6730A watches move at 20-second intervals. But the input indicating light of the Quartz Tester blinks every 10 seconds because they transmit the pulse for measuring the daily rate at 10-second intervals.)</li> </ul>	<p><b>Result:</b></p> <p>Blinking at 10 seconds intervals: Normal No blinking at 10 seconds intervals: Defective</p>
<b>CHECK BATTERY VOLTAGE</b>	
Range to be used: DC 3V	<p><b>Result:</b></p> <p>More than 1.5V: Normal Less than 1.5V: Defective</p>
<b>CHECK BATTERY CONDUCTIVITY</b>	
<ul style="list-style-type: none"> <li>Check to see if the circuit block screws are tightened firmly.</li> <li>Check to see if there is any contamination on the battery, battery connection (+) and battery connection (-).</li> </ul>	
<b>CHECK CIRCUIT BLOCK CONDUCTIVITY</b>	
<b>CHECK RESET AND TRAIN WHEEL SETTING CONDITIONS</b>	
<p>After reassembling the setting mechanism, check to see if the train wheel setting lever A, and B function correctly.</p> <p>[Reset portion of the train wheel setting lever A]</p> <ul style="list-style-type: none"> <li>With the crown at the normal position</li> </ul>	<p><b>Result:</b></p> <p>Clearance : Normal No clearance : Defective Replace the train wheel setting lever A with a new one.</p>
	

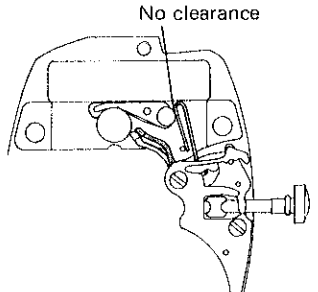
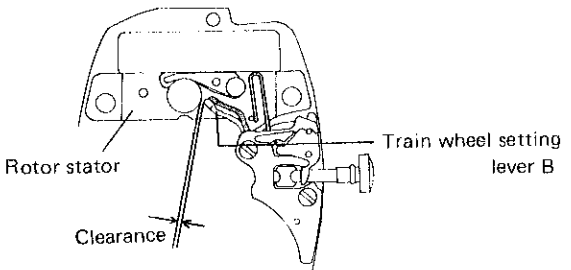
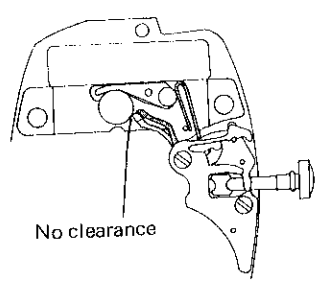
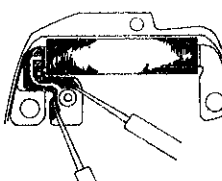
Procedure	
<ul style="list-style-type: none"> <li>With the crown at the first click position</li> </ul>	<p>No clearance : Normal Clearance : Defective Replace the train wheel setting lever A with a new one.</p>
	
<p>[Setting portion of the train wheel setting lever B]</p> <p>Train wheel setting portion</p> <ul style="list-style-type: none"> <li>With the crown at the normal position</li> </ul>	<p><b>Result:</b></p> <p>Clearance : Normal No clearance : Defective Replace the train wheel setting lever A with a new one.</p>
	
<ul style="list-style-type: none"> <li>With the crown at the first click position</li> </ul>	<p>No clearance : Normal Clearance : Defective Replace the second setting lever A with a new one.</p>
	
<b>CHECK COIL BLOCK</b>	
<ul style="list-style-type: none"> <li>Checking the coil block alone may result in short circuit or broken coil wire. Be sure to check the coil block with the rotor stator reassembled on the main plate together with it.</li> </ul>	<p><b>Result:</b></p> <p>2.6kΩ ~ 2.9kΩ: Normal Less than 2.6kΩ (Short circuit) / More than 2.9kΩ (Broken wire): Defective Replace the coil block with a new one.</p>
	<p>Range to be used: OHMS R x 100</p>

## Procedure

### CHECK ACCURACY

- Use the 10-second gate of the Quartz Tester for measuring time accuracy. Though Cal. 6730A watches move at 20-second intervals, they transmit the pulse for measuring the daily rate every 10 seconds.
- This watch uses the chip condenser for time accuracy adjusting. When time accuracy adjusting is required, replace the circuit block with a new one.

### CHECK CURRENT CONSUMPTION

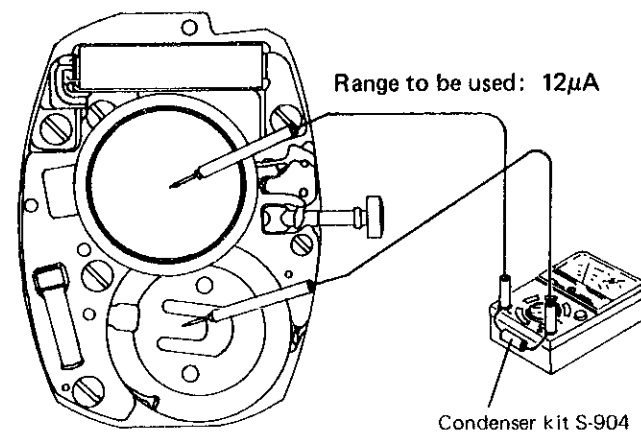

#### Result:

- Less than 0.4µA: Normal
- More than 0.4µA: Defective

#### Remarks for measuring the current consumption:

- As Cal. 6730A watches move at 20-second intervals, the pointer of the Volt-ohm-meter swings once every 20 seconds when measuring the current consumption.
- When the (+) and (-) probes of the Volt-ohm-meter are applied to the watch as shown in the illustration above, the pointer swings slightly, indicating the current is flowing through the IC. After this, a larger swing of the pointer continues at 20-second intervals. This is the indication that the motor driving current flows besides the current flowing through the IC.
- The current consumption is calculated as follows.

#### [Example]

Assume the IC current = 0.2µA and IC current + motor driving current = 0.6µA, and the current necessary for driving the motor alone is 0.4µA. This value, however, shows the one when the watch moves at 20-second intervals. Therefore, to obtain the current consumption, it must be converted into the value measured at one-second intervals. Reduce the value (0.4µA) to 1/20, and the current consumption necessary only for the step motor is 0.02µA.

Accordingly the value of current consumption by this watch is: 0.2µA + 0.02µA = 0.22µA.

- Calculate the current consumption in the same manner when the Micro Test is used.

All procedures of Disassembling, Reassembling, Checking and Adjustment are completed.