

SEIKO

QUARTZ

Cal. 8222A

PARTS LIST

Cal. 8222A

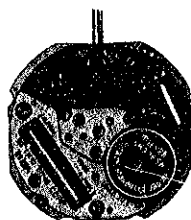

122 820



131 822



☆221 820



231 820



☆241 820



261 820



☆271 820



281 820



282 821

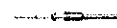

354 825



383 821



384 820



388 821



701 820



737 820

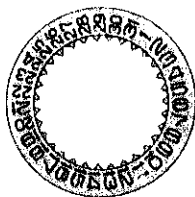

☆801 513



802 821



808 821



810 820



962 820



4001 820



4002 820



4146 820



4239 820



4242 821



4259 826



4270 820



4408 820



☆Maxell SR936SW

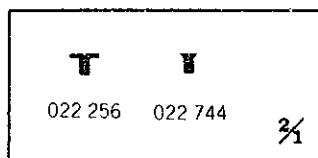

Cal. 8222A

Characteristics

Casing diameter : ϕ 24.0 mm
 Maximum height : 3.8 mm without battery
 Jewels : 4 j
 Frequency of quartz crystal oscillator : 32,768 Hz (Hz=Hertz Cycles per second)
 Driving system : Step motor system (2 poles)
 Regulation system : Trimmer condenser
 Second setting device
 Calendar (Date)
 Instant setting device for date calendar
 Battery life indicator : Second hand moves in two-second interval

PART NO.	PART NAME	PART NO.	PART NAME
122 820	Center wheel bridge	027 034	Tube for center wheel bridge
131 822	Third wheel bridge	☆027 035	Tube for third wheel bridge A
☆221 820	Center wheel & pinion	☆027 036	Tube for third wheel bridge B
☆221 821	Center wheel & pinion	☆027 037	Tube for third wheel bridge C
231 820	Third wheel & pinion	☆027 038	Tube for circuit block screw A
☆241 820	Fourth wheel & pinion	☆027 039	Tube for circuit block screw B
☆241 821		027 040	Pin for anti-magnetic shield plate screw
261 820	Minute wheel	027 853	Minute wheel pin
☆271 820	Hour wheel (Silver)	027 946	Eccentric dial pin
☆271 821	Hour wheel (Gold)	☆U.C.C.394	Silver oxide battery
281 820	Setting wheel	☆Maxell SR936SW	
282 821	Clutch wheel		
354 825	Winding stem		
383 821	Setting lever		
384 820	Yoke (Clutch lever)		
388 821	Setting lever spring		
701 820	Fifth wheel & pinion		
737 820	Date correcter setting wheel		
☆801 513	Date dial		
☆801 514			
802 821	Date driving wheel		
808 821	Date dial guard		
810 820	Date jumper		
962 820	Intermediate wheel for calendar correction		
4001 820	Circuit block		
4002 820	Coil block		
4146 820	Step rotor		
4239 820	Rotor stator		
4242 821	Battery connection (+)		
4259 826	Anti-magnetic shield plate		
4270 820	Battery connection (-)		
4408 820	Circuit block spacer		
022 256	Center wheel bridge screw		
022 256	Third wheel bridge screw		
022 256	Circuit block screw		
022 256	Anti-magnetic shield plate screw		
022 256	Setting lever spring screw		
022 744	Date dial guard screw		
011 537	Upper hole jewel for third wheel		
011 537	Upper hole jewel for fifth wheel		
011 537	Upper hole jewel for step rotor		
011 537	Lower hole jewel for step rotor		
023 340	Yoke banking pin		
023 369	Tube for yoke		
023 785	Lower bush for third wheel		
023 785	Lower bush for fifth wheel		

☆ ⇨ Please see remarks on the reverse page.
 Part numbers in light letters are not shown in photos.



Cal. 8222A

Remarks :

Center wheel & pinion, Fourth wheel & pinion, Hour wheel.

There are two different types as specified below.

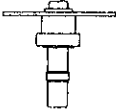
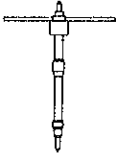
Combination :

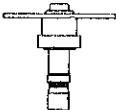
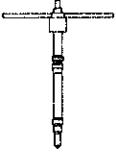
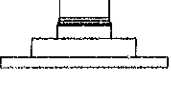
Type	Center wheel & pinion	Fourth wheel & pinion	Hour wheel
a			 Silver
	☆221 820	☆241 820	☆271 820
b			 Gold
	☆221 821	☆241 821	☆271 821

Date dial

The markers on the date dial are printed in the different portions.

- ☆801 513.....The marker is close to the dial rim. It's **8.8 mm** between the center of the dial and the calendar frame position.
- ☆801 514.....The marker is close to the center of the dial ring. It's **8.3 mm** between the center of the dial and the calendar frame position.

Used when both the crown and the calendar frame are located at **3** o'clock position.

If any other type of date dial is required, specify ① Cal. No. ② The crown position ③ The calendar frame position and ④ Dial No.

Tube for third wheel bridge (A, B, C), Tube for circuit block screw (A, B)

- ☆027 035
- ☆027 036
- ☆027 037
- ☆027 038
- ☆027 039

..... Refer to the illustration below for the position of tube for third wheel bridge (A, B, C) and tube for circuit screw (A, B).

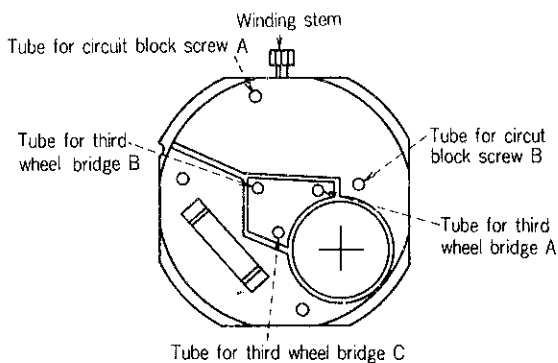

Battery

- ☆U.C.C.394
- ☆Maxell SR936SW

The applied battery for this calibre might be added the substitutive in the future. In that case, please refer to separate "**BATTERIES FOR SEIKO QUARTZ WATCHES.**"