

SEIKO

QUARTZ

Cal. 7123A

PARTS LIST

Cal. 7123A

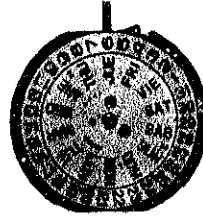

131 079



231 029



☆241 051



261 006



☆270 023



☆271 044



282 017



354 055



383 046



384 017



389 010



☆397 026



☆470 150



495 003



556 012



560 004



701 007



719 003

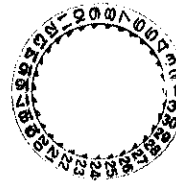

☆801 077



802 019



808 025



810 011



817 014



868 011

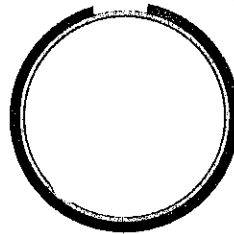

☆884 104



963 007



4001 112



4002 010



4146 007



4219 012



4239 018



4242 075



4270 024



011 542



Maxell SR1130SW



012 152



012 153



012 154



012 713



013 975



017 133



017 134



017 135



017 136



017 137



017 138



017 139



017 141



017 142

3/4

Cal. 7123A

Characteristics:

Casing diameter: ϕ 26.00 mm
 Maximum height: 3.30 mm without battery
 Jewels: 2 j
 Frequency of quartz crystal oscillator: 32,768 Hz (Hz=Hertz Cycle per second)
 Driving system: Step motor system (2 poles)
 Regulation system: Trimmer condenser
 Second setting device
 Calendar (Day & Date)
 Instant setting device for day & date calendar
 Bilingual change-over system for day of the week
 Battery life indicator: Second hand moves in two-second interval.

PART NO.	PART NAME	PART NO.	PART NAME
131 079	Third wheel bridge	012 713	Date dial guard (with day corrector) screw
231 029	Third wheel & pinion	013 975	Eccentric dial pin
☆241 051	Fourth wheel & pinion (4.91 mm)	017 133	Tube for third wheel bridge screw A
☆241 052	Fourth wheel & pinion (5.11 mm)	017 134	Tube for third wheel bridge screw B
261 006	Minute wheel	017 135	Tube for coil block A
☆270 023	Center minute wheel with cannon pinion (2.74 mm)	017 136	Tube for coil block B
☆270 024	Center pinion with cannon pinion (2.94 mm)	017 137	Tube for circuit block
☆271 044	Hour wheel (1.77 mm, gold)	017 138	Tube for yoke (Tube for clutch lever)
☆271 045	Hour wheel (1.92 mm, silver)	017 139	Tube for setting lever axle spring screw
282 017	Clutch wheel	017 139	Tube for date dial guard screw C
354 055	Winding stem	017 141	Guide tube for day corrector A
383 046	Setting lever	017 142	Guide tube for day corrector B
384 017	Yoke (Clutch lever)	☆Maxell SR1130SW	Silver oxide battery
389 010	Setting lever axle spring	☆SEIKO SB-AU	
☆397 026	Lever for unlocking stem		
☆470 150	Day star with dial disk		
495 003	Spacer for third wheel bridge		
556 012	Date finger		
560 004	Friction spring for fourth wheel & pinion		
701 007	Fifth wheel & pinion		
719 003	Day corrector		
☆801 077	Date dial		
☆801 097			
802 019	Date driving wheel		
808 025	Date dial guard (with day corrector)		
810 011	Date jumper		
817 014	Intermediate date wheel		
868 011	Day finger		
☆884 104	Holding ring for dial		
963 007	Snap for day star with dial disk		
4001 112	Circuit block		
4002 010	Coil block		
4146 007	Step rotor		
4219 012	Insulator for battery connection		
4239 018	Rotor stator		
4242 075	Plus terminal of battery connection		
4270 024	Battery connection		
011 542	Upper hole jewel for step rotor		
011 542	Lower hole jewel for step rotor		
012 152	Third wheel bridge screw		
012 152	Circuit block screw		
012 152	Coil block screw		
012 152	Setting lever axle spring screw		
012 153	Day finger screw		
012 154	Date jumper screw		





☆⇨Please see remarks on the reverse page.
 Part numbers in light letters are not shown in photos.

Cal. 7123A

Remarks:

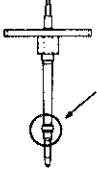
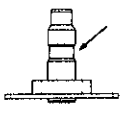
Fourth wheel & pinion, Center minute wheel with cannon pinion, Hour wheel
There are two different types as specified below.

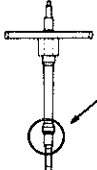
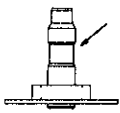
Combination:

Type	Fourth wheel & pinion	Center minute wheel with cannon pinion	Hour wheel
a			Gold 
	☆241 051	☆270 023	☆271 044
b			Silver 
	☆241 052	☆270 024	☆271 045

Lever for unlocking stem

The size of a lever for unlocking stem is determined based on the design of cases. When adjusting the length of the lever for unlocking stem by cutting its tail, be sure that the tail partly comes out of the brim of the dial as shown in the illustration. If the tail is hidden from view by the dial, it will be difficult to disassemble the winding stem.

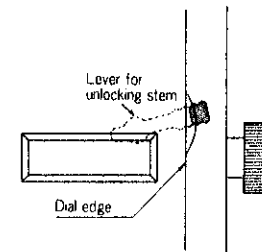

Day star with dial disk

☆470 150(English↔Spanish, black figures on white background).....Used when both the crown and the calendar frame are located at **3** o'clock position.

If any other type of day star with dial disk is required, specify the number printed on the disk.

Date dial

☆801 077(Black figures on white background).....Used when both the crown and the calendar frame are located at **3** o'clock position.
☆801 097(White figures on black background).....located at **3** o'clock position.

If any other type of date dial is required, specify ① Cal. No. ② Jewels ③ The crown position ④The calendar frame position and ⑤ Dial. No.

Holding ring for dial

The type of holding ring for dial is determined based on the design of cases and dials. If the shape of holding ring for dial is different from the photograph, check the case number and refer to "SEIKO Quartz Casing Parts List" to choose a corresponding holding ring for dial.

Battery

The applied battery for this calibre might be added the substitutive in the future. In that case, please refer to separate "BATTERIES FOR SEIKO QUARTZ WATCHES."

TECHNICAL GUIDE

SEIKO
QUARTZ

CAL. 7123A

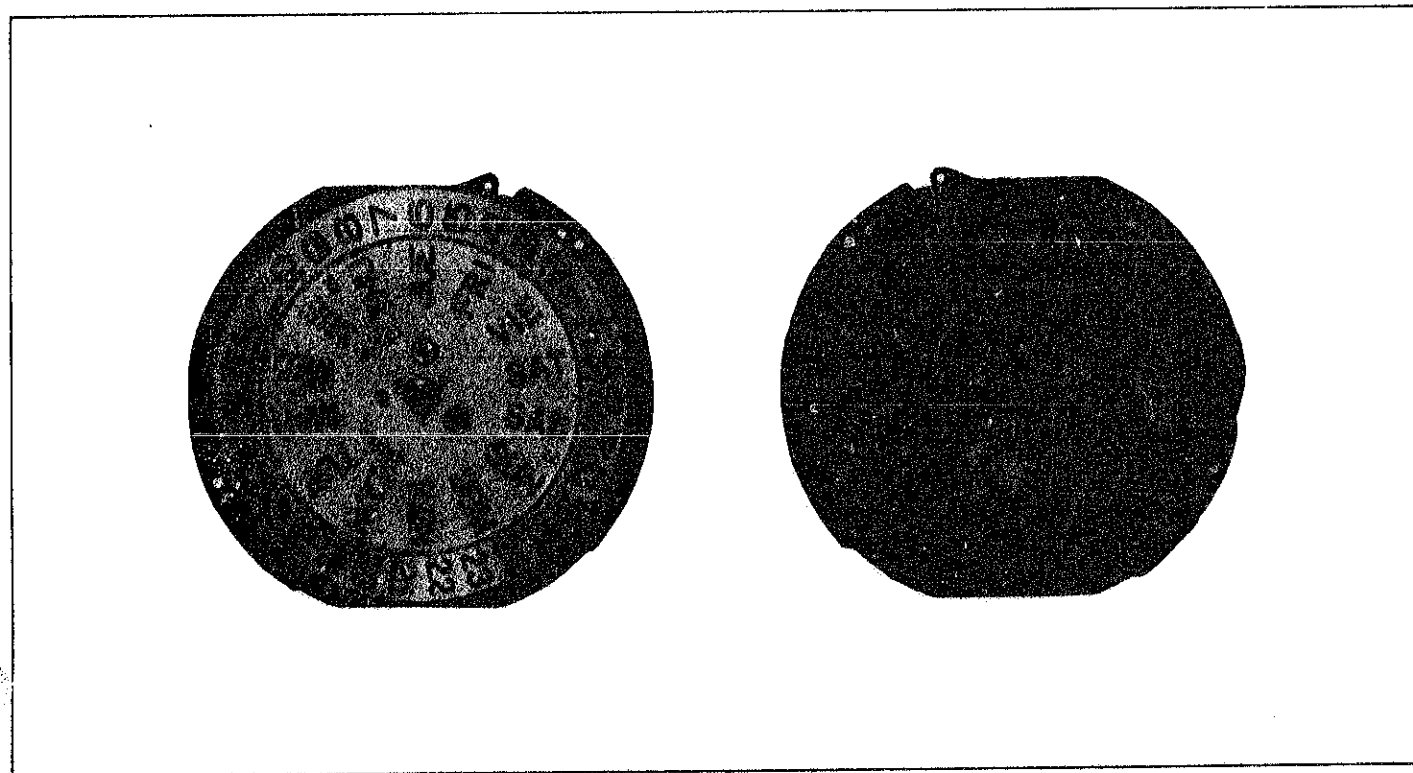

CONTENTS

I. SPECIFICATIONS	1
II. DISASSEMBLING, REASSEMBLING, LUBRICATING AND CLEANING	2
1. Calendar mechanism	2
2. Electronic circuit	4
3. Gear train and second setting mechanism	6
III. CHECKING AND ADJUSTMENT	9
1. Guide table for checking and adjustment	9
2. Procedures for checking and adjustment	10
A : Check output signal	10
B : Check battery voltage	10
C : Check battery conductivity	10
D : Check circuit block conductivity	10
E : Check reset and second setting conditions	11
F : Check coil block	12
G : Check output signal	12
H : Check accuracy	12
I : Check battery life indicator	12
J : Check current consumption	12

I. SPECIFICATIONS

Item	Cal. No.	7123A
Time indication		3-hand time indication (hour, minute & second) Calendar (day & date) Bilingual changeover system for the day of the week Instant day and date setting device
Additional mechanism		Second setting device (Stops at every second) Battery life indicator Electronic circuit reset switch
Crystal oscillator		32,768 Hz (Hz = Hertz Cycle per second)
Loss/gain		Loss/gain at normal temperature range Monthly rate : less than 15 seconds (Annual rate : less than 3 minutes)
Casing diameter		φ26.0 mm (23.7 mm between 3 o'clock and 9 o'clock sides)
Height		3.3 mm without battery
Operational temperature range		-10°C ~ +60°C (14°F ~ 140°F)
Driving system		Step motor system (2 poles)
Regulation system		Trimmer condenser
Battery power		Silver oxide battery SEIKO SB-AU, Maxell SR1130SW Battery life is approximately 5 years. Voltage: 1.55V
Jewel		2 jewels

SEIKO Quartz Cal. 7123A is thin and multifunctional quartz crystal oscillator watches for men with high accuracy and reliability and allow their diversified development of various models.

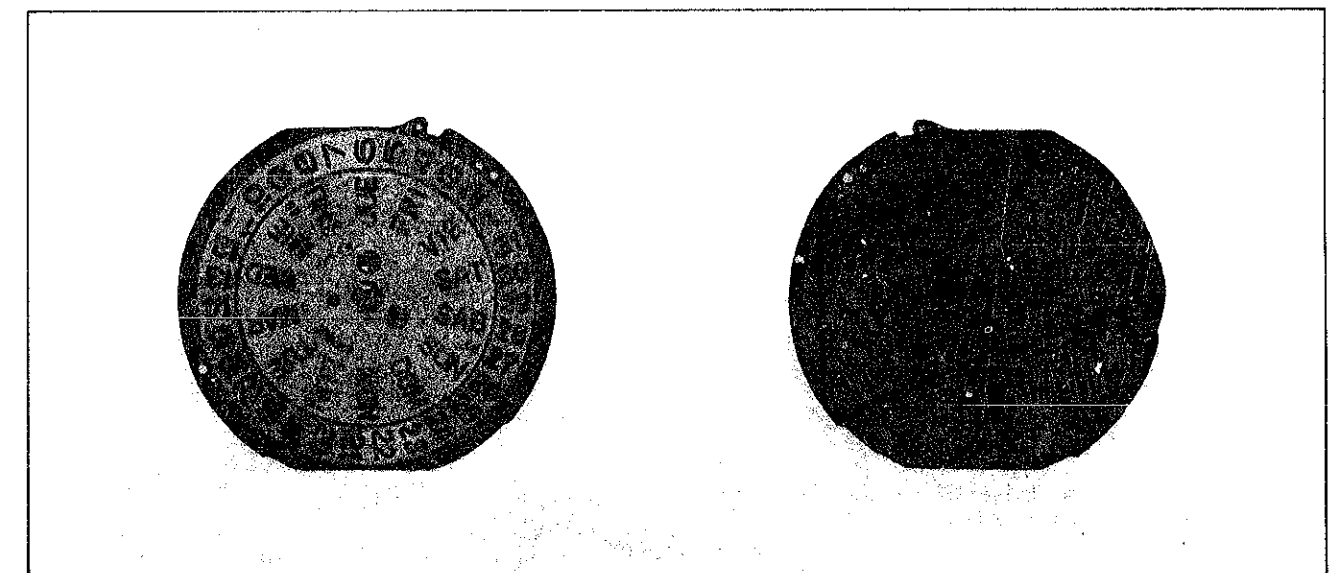

II. DISASSEMBLING, REASSEMBLING, LUBRICATING AND CLEANING

Disassembling and reassembling

Disassembling procedures Figs. ① → ④⑩

Reassembling procedures Figs. ④⑩ → ①

Lubricating

Types of oil

Moebius A

SEIKO Watch Oil S-6

Oil quantity

Liberal

Normal

Extremely small

Use the movement holder S-651 for Cal. 4316,48 series and 58 series.

1. Calendar mechanism

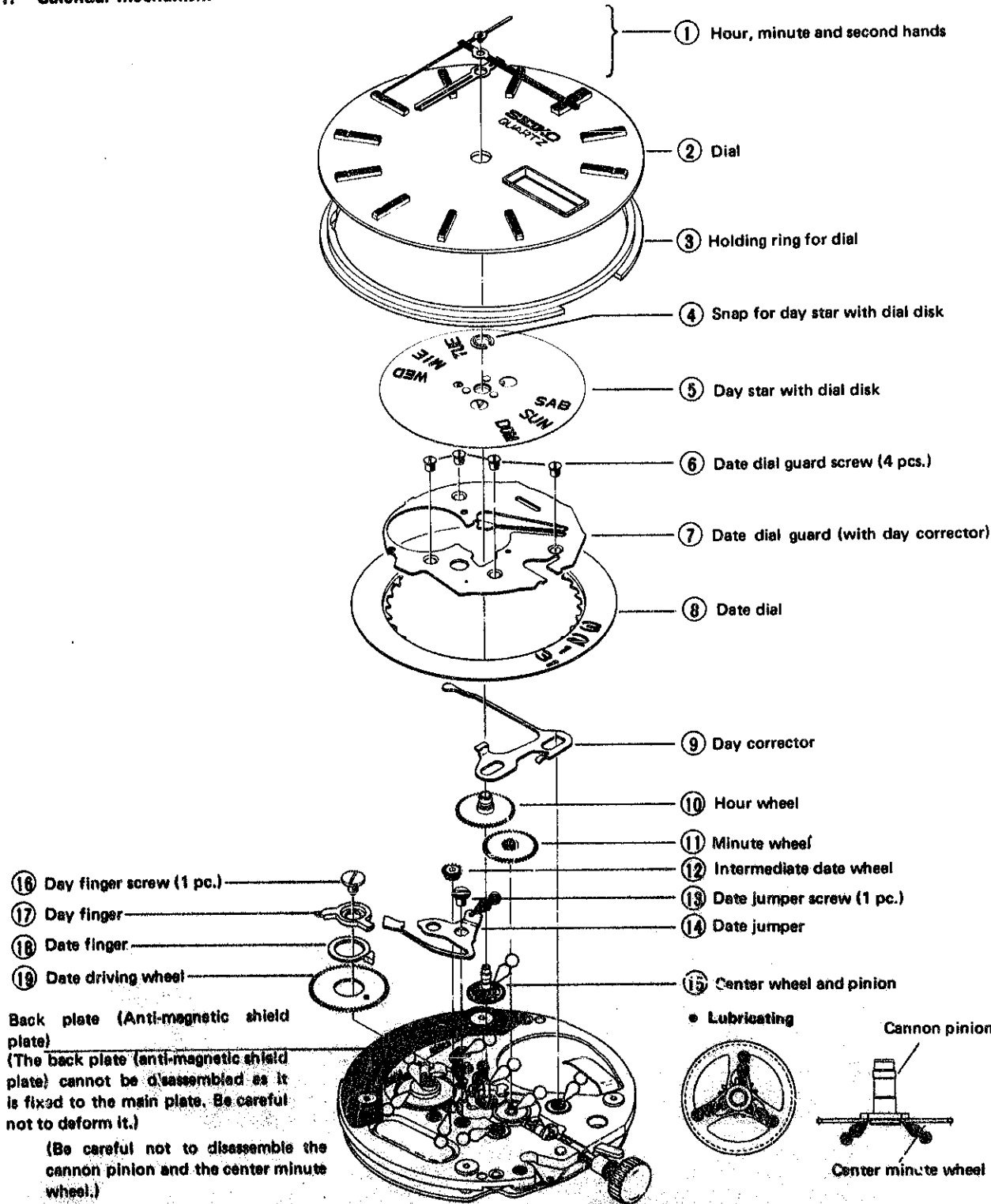

Remarks for disassembling and reassembling

① How to disassemble and reassemble the hands

When disassembling or reassembling, always pull the crown out to the second click position. The second hand must be placed just in line with a second mark. (Either odd or even second mark will do.)

② How to disassemble and reassemble the dial

After turning the eccentric dial pin between 90° and 150° , it is possible to remove and replace the dial.

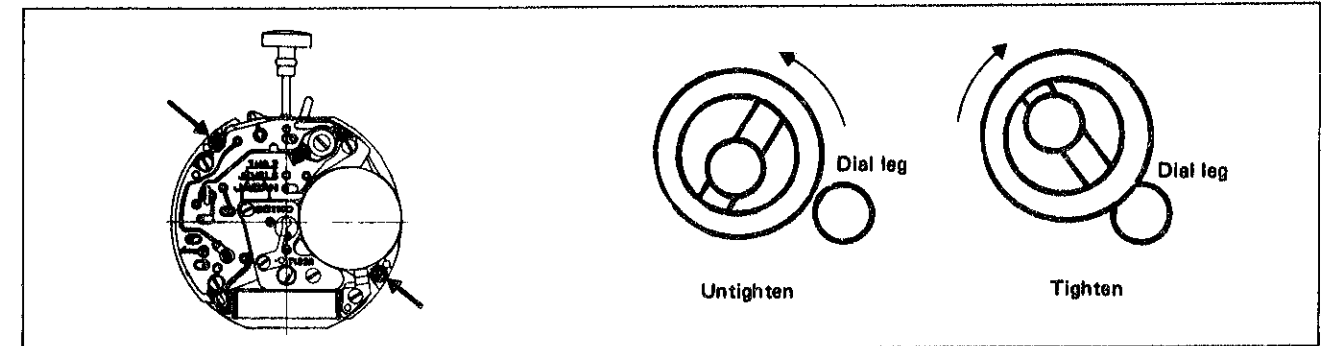

⑩ Day corrector

• Lubricating

Lubricate the contacting portions of the sides of the pins on the main plate, ①, ② and ③ with the day corrector.

• Reassembling

Set the day corrector in order of the pins on the main plate, ①, ② and ③.

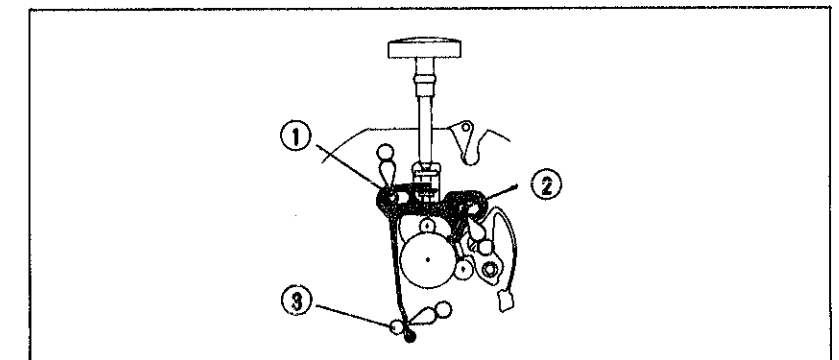

⑯ ~ ⑲ How to reassemble the date finger and the day finger

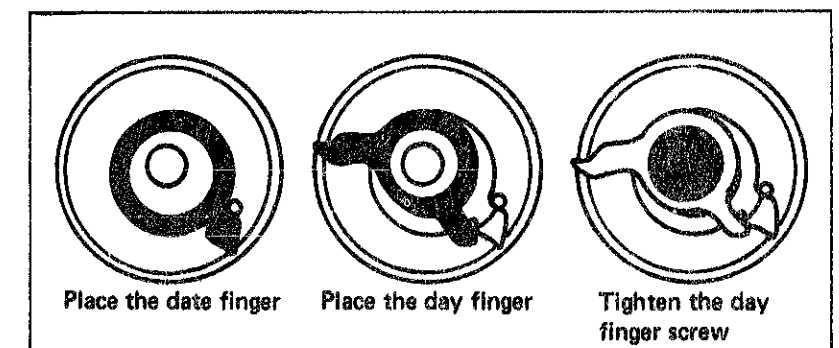

• How to remove the stem with crown

From the dial side
A part of the lever for unlocking stem is seen at the outer circumference of the dial. Push it down to remove the stem with crown.

From the circuit block side

A part of the setting lever is seen at the outer circumference of the main plate (arrow-marked) in the normal position of the crown. Push it down to remove the stem with crown.

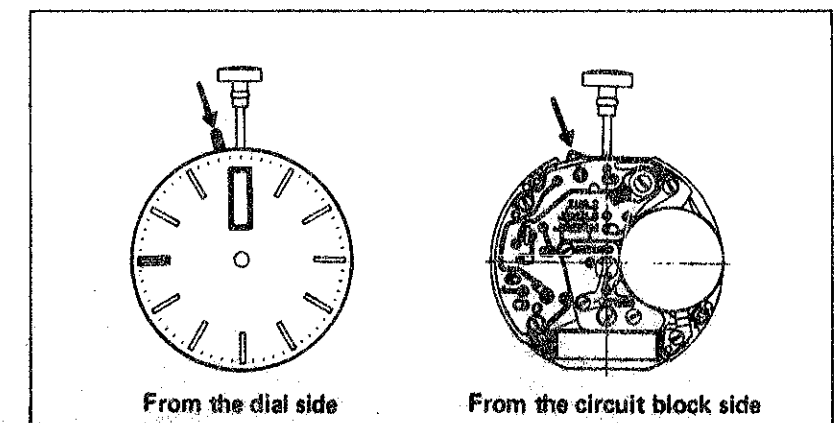

2. Electronic circuit

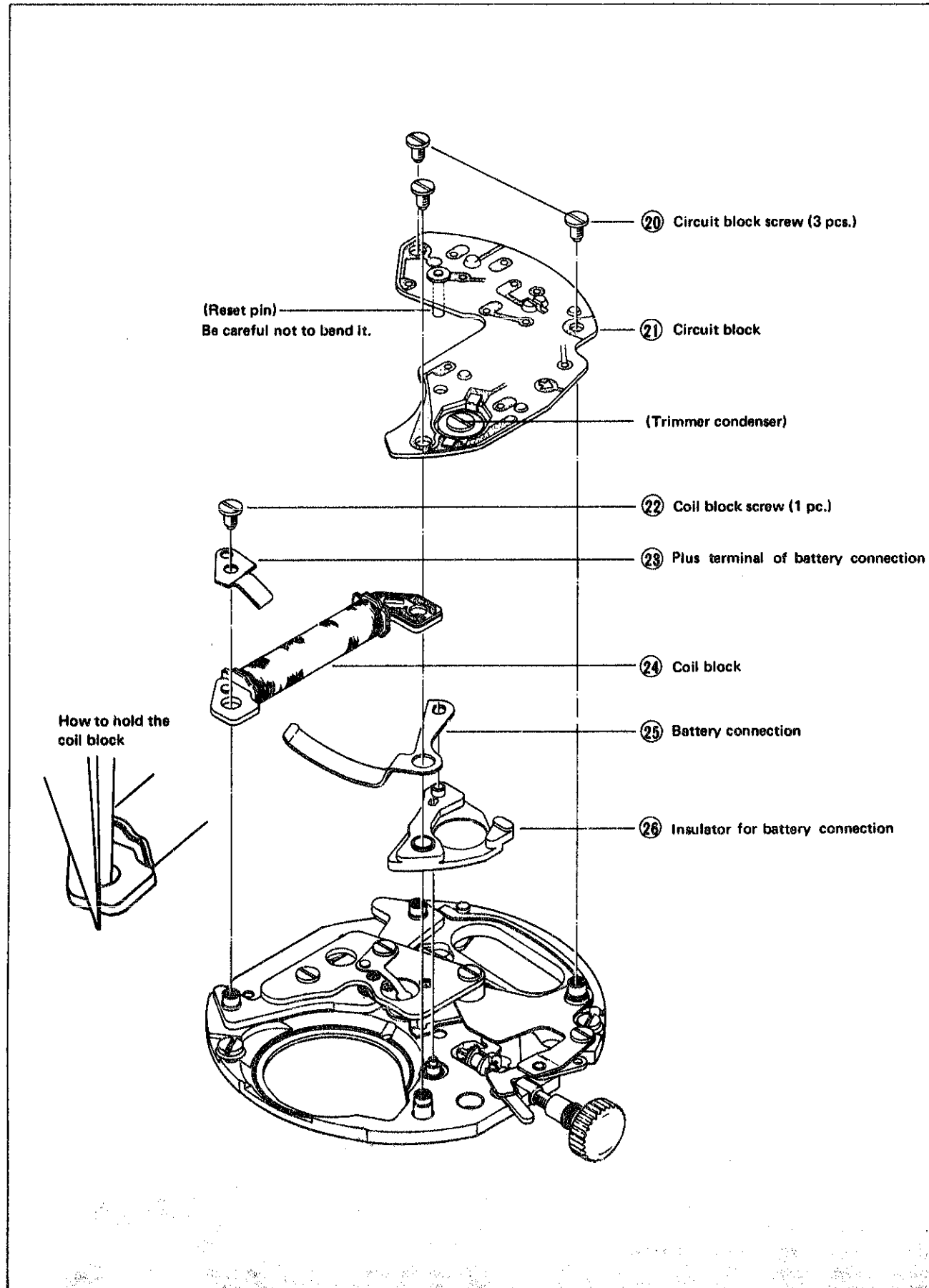

• Remarks for disassembling and reassembling

① Circuit block

When disassembling or reassembling, pull the crown out to the normal or first click position and reassemble the circuit block after the reset portion of the yoke is detached from the reset pin.

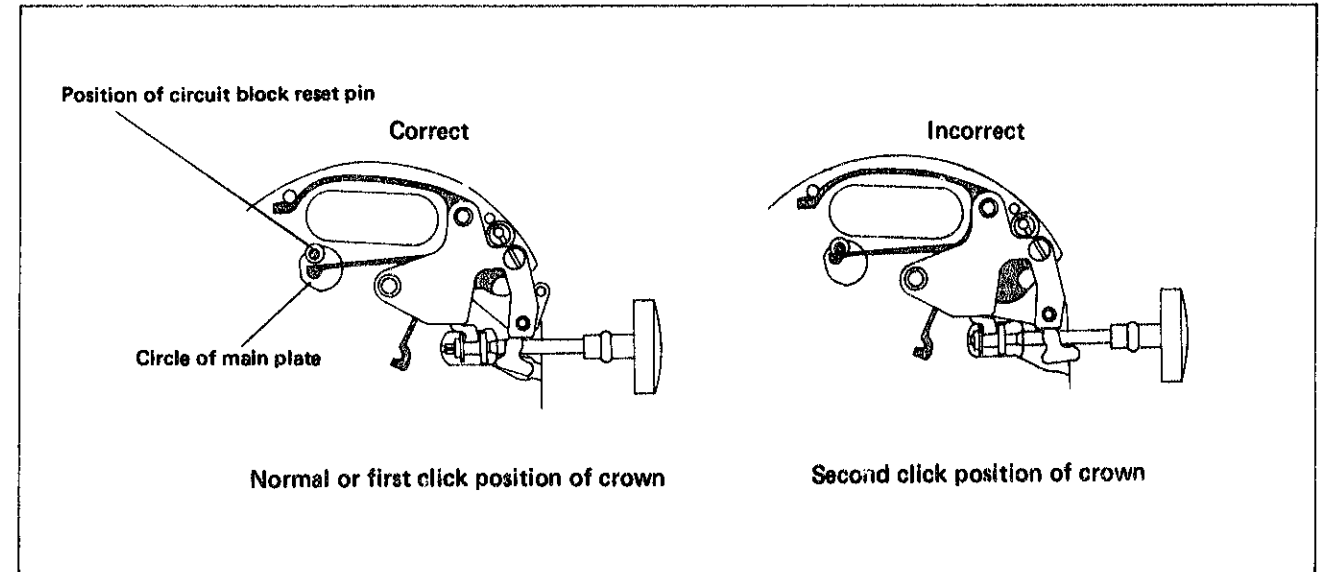

• List of screws used

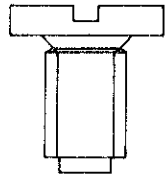
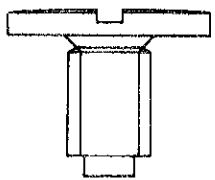
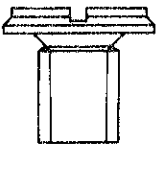
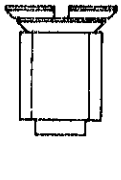
			
Circuit block screw Coil block screw Third wheel bridge screw Setting lever spring screw	Day finger screw	Date jumper screw	Date dial guard screw
8 pieces	1 piece	1 piece	4 pieces

3. Gear train and second setting mechanism

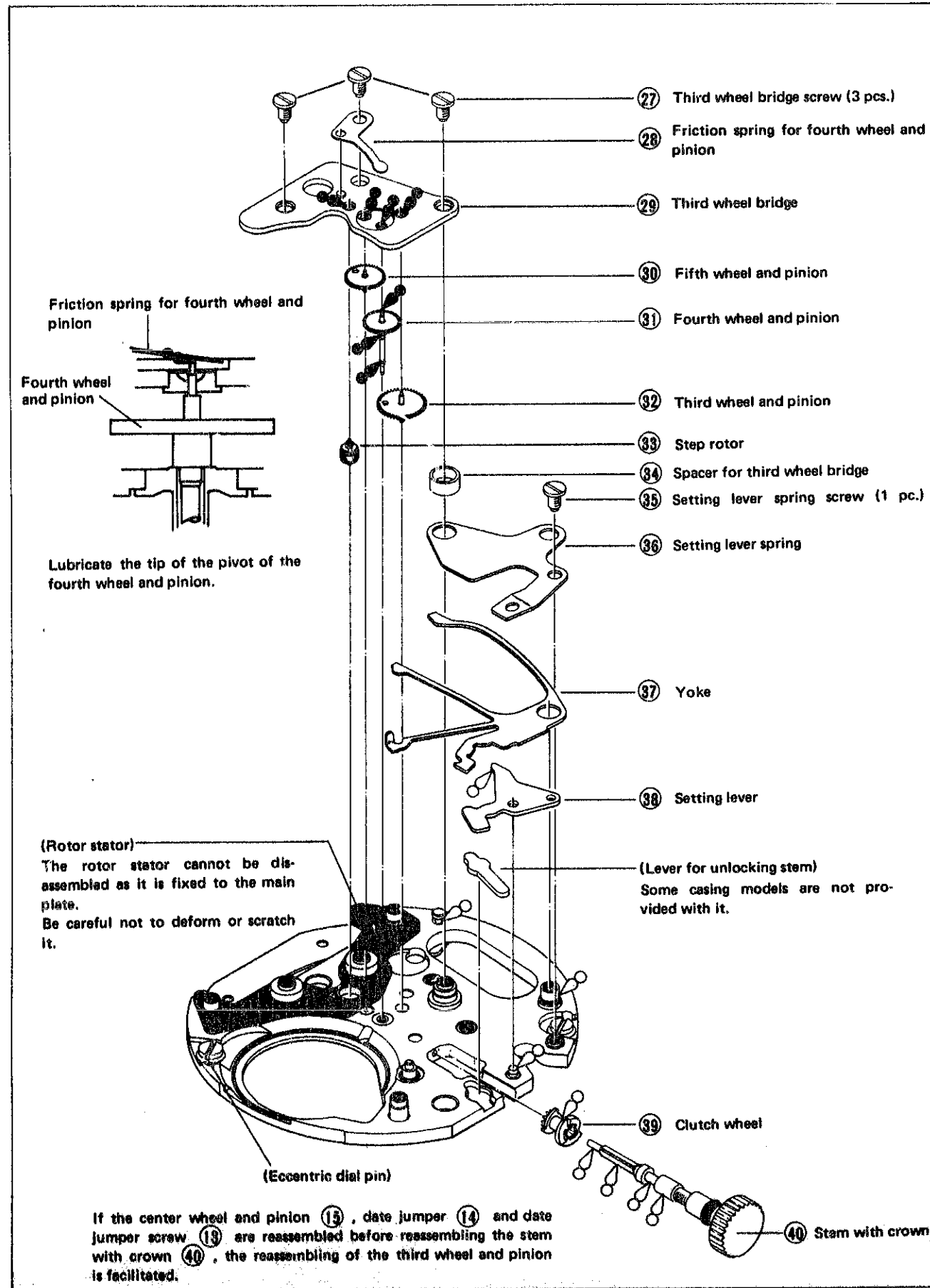

Remarks for disassembling and reassembling

30 ~ 37 Functions of the gear train and the yoke (at setting and reset portions)

- Crown at the normal and first click position
There must be clearance between the fourth wheel and setting portion of yoke, reset pin and reset portion of yoke.

- Crown at the second click position
There must not be clearance between the fourth wheel and setting portion of yoke, reset pin and reset portion of yoke.

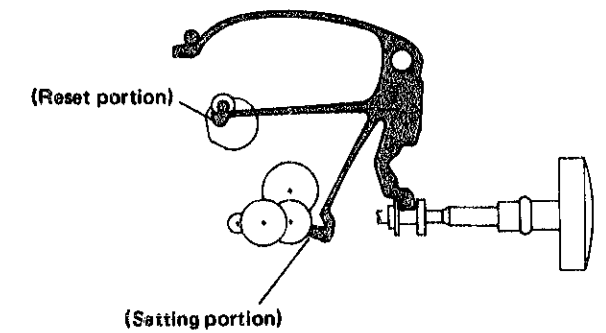
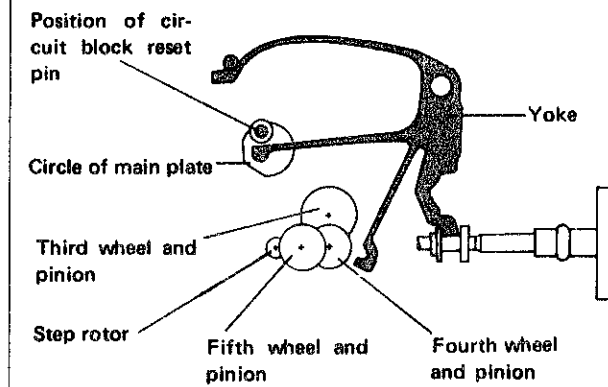

- Make sure that the second setting and reset are secured by the pulling out operation of the crown.

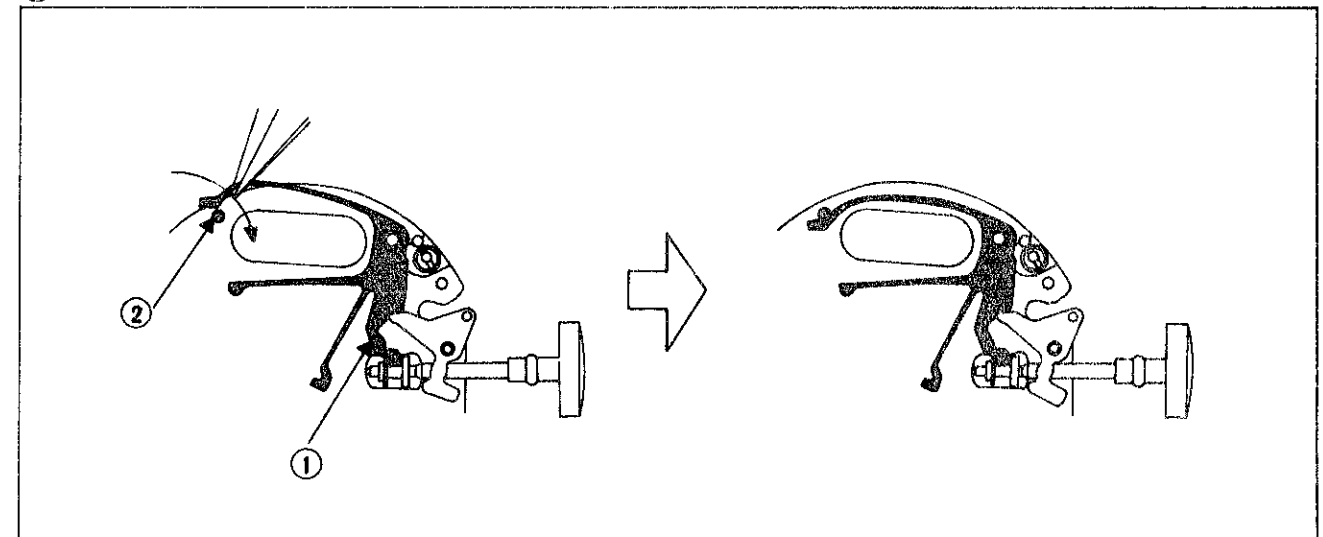

37 How to reassemble the yoke



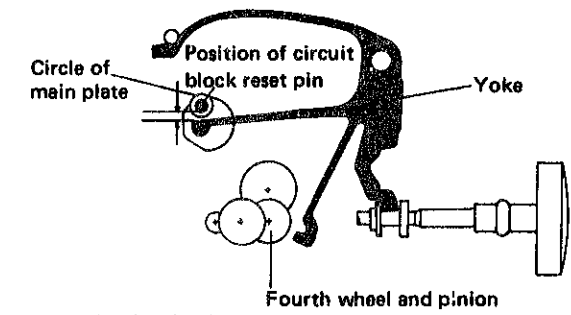
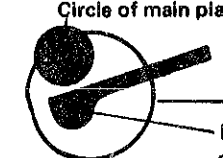
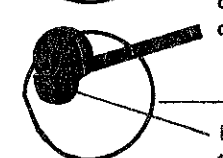

- With the crown at the normal or first click position, push the (1) portion of the yoke with a finger and set the yoke inside the pin (2) while holding the spring portion with tweezers.
- Make sure that the crown can be operated correctly.

2. Procedures for checking and adjustment

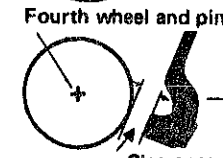
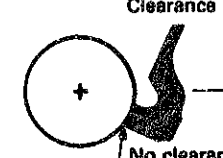
	Procedures	Results	Adjustment and repair
CHECK OUTPUT SIGNAL	Check output signal.	One-second blinking	→ Proceed to 1.
		No one-second blinking	→ Proceed to 2.
CHECK BATTERY VOLTAGE	Check battery voltage.	More than 1.5V	→ In procedure 1 if one-second blinking is found, proceed to Check mechanical portion . → In procedure 2 if one-second blinking is not found, proceed to Check electronic circuit block .
		Less than 1.5V	→ Proceed to Replace the battery . If a watch operates after battery replacement, proceed to 1. If a watch does not operate after battery replacement, proceed to Check electronic circuit block .
CHECK BATTERY CONDUCTIVITY	1. Make sure that the coil block screw is tightened firmly. 2. Check for any contamination on the connecting portion of battery, the battery connection, the plus terminal of battery connection and holding spring for battery.	No loosened screw Loosened screw Untaminated Contaminated	→ Proceed to 2. → Retighten the screws. → Proceed to 1. → Wipe off carefully.
CHECK CIRCUIT BLOCK CONDUCTIVITY	1. Check to see if the circuit block screws (3 pcs.) are tightened firmly. 2. Check the circuit block for any break in the welded portion, short circuit, pattern break and contamination.	No loosened screws Loosened screws No break in the welded portion, short circuit, pattern break or contamination Break in the welded portion, short circuit or pattern break Contaminated	→ Proceed to 2. → Retighten the screws. → Proceed to 1. → Replace the circuit block. → Wipe off carefully.

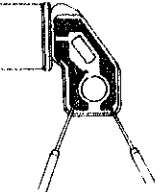
	Procedures	Results	Adjustment and repair
CHECK RESET AND SECOND SETTING CONDITIONS	1. Check to see if the second hand stops immediately after the crown is pulled out to the second click position and if it starts promptly after one second when the crown is pushed in to the normal position. 2. Check for the clearance between the reset portion of the yoke and the reset pin (with the circuit block removed).	Stops completely and starts after one second Does not stop or moves irregularly	→ Proceed to 1. → Proceed to 2.
			
	① With the crown at the normal and first click position		→ Proceed to 2 ② Located at the outer circumference of the circle of the main plate
	② With the crown at the second click position		→ Replace the yoke. Located at the center of the circle of the main plate
	3. Check for the clearance between the second setting portion of the yoke and the fourth wheel and pinion (with the circuit block removed).		→ Proceed to 3 ②
	① With the crown at the normal and first click position		→ Replace the yoke.
	② With the crown at the second click position		→ Proceed to 1.
			→ Replace the yoke.

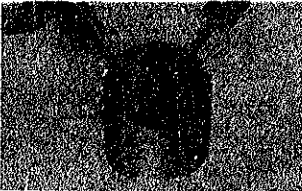
	Procedures	Results	Adjustment and repair
CHECK COIL BLOCK	<p>Check coil block.</p> 	<p>2.0kΩ ~ 4.0kΩ</p> <p>Less than 2.0kΩ</p> <p>Short circuit</p> <p>More than 4.0kΩ</p> <p>Broken coil wire</p>	<p>→ Electronic circuit block is being checked. Proceed to [] .</p> <p>→ Mechanical portion is being checked. Proceed to [] .</p> <p>→ Replace the coil block.</p>
CHECK OUTPUT SIGNAL	<p>Check for output signal.</p>	<p>One-second blinking</p> <p>No one-second blinking</p>	<p>→ Functioning → Proceed to [] .</p> <p>→ Not functioning → Proceed to <u>Check mechanical portion</u> .</p> <p>→ Replace the circuit block.</p>
CHECK ACCURACY	<p>Check accuracy.</p>	<p>Normal</p> <p>Defective</p>	<p>→ Replace the battery.</p> <p>→ Adjust time accuracy.</p>
CHECK BATTERY LIFE INDICATOR	<p>Set up the Micro Test.</p> <p>Clip red (+) ... Crown or stem with crown</p> <p>Probe black (-) ... Battery connection</p> <p>1. Set the voltage at 1.25V. Check to see if the second hand moves at 2-second intervals.</p>  <p>2. Set up the Micro Test. Set the voltage at 1.5V. Check to see if the second hand moves at 1-second intervals.</p>	<p>The second hand moves at 2-second intervals</p> <p>The second hand moves at 1-second intervals</p> <p>The second hand moves at 1-second intervals</p> <p>The second hand moves at 2-second intervals</p>	<p>→ Proceed to [] 2.</p> <p>→ Replace the circuit block.</p> <p>→ Proceed to [] .</p> <p>→ Replace the circuit block.</p>
CHECK CURRENT CONSUMPTION	<p>Place the battery on the third wheel bridge with its (-) surface faced up.</p> <p>Probe red (+) ... Battery connection</p> <p>Probe black (-) ... Battery surface (-)</p> 	<p>Less than 2.0μA</p> <p>More than 2.0μA</p>	<p>→ Normal</p> <p>→ Proceed to <u>Check electronic circuit</u> .</p> <p>Note: If the pointer of the volt-ohm-meter scales out and the current consumption cannot be measured, reset its range, e.g. at DC 30mA. Next, when the pointer is stabilized with the probes of the volt-ohm-meter applied as shown in the left illustration, return the range to DC 12μA (or DC 0.03mA) and read the value indicated.</p>

All procedures of Disassembling, Reassembling, Checking and Adjustment are completed.