

PARTS CATALOGUE/ TECHNICAL GUIDE

Cal. 2Y00A

[SPECIFICATIONS]

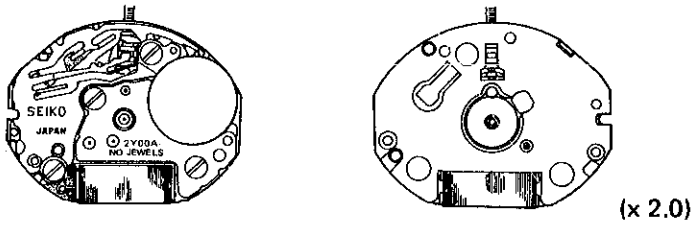

Item		Cal. No.	2Y00A
Movement			
Movement size	Outside diameter	13.0 mm between 3 o'clock and 9 o'clock sides 15.5 mm between 6 o'clock and 12 o'clock sides	
	Casing diameter	15.0 mm between 6 o'clock and 12 o'clock sides	
	Height	1.8 mm	
Time indication		2 hands (Hand motion: 20-second step)	
Driving system		Step motor (Load compensated driving pulse type)	
Additional mechanism		<ul style="list-style-type: none"> • Electronic circuit reset switch • Train wheel setting device 	
Loss/gain		Monthly rate at normal temperature range: less than 20 seconds	
Regulation system		Nil	
Measuring gate by quartz tester		Use 10-second gate.	
Battery		SEIKO SR516SW, Maxell SR516SW Battery life is approximately 3 years. Voltage: 1.55V	
Jewels		0 jewels	

PARTS CATALOGUE



Cal. 2Y00A

Disassembling procedures Figs. : ① → ②⑥
 Reassembling procedures Figs. : ②⑥ → ①

Lubricating: Types of oil Oil quantity

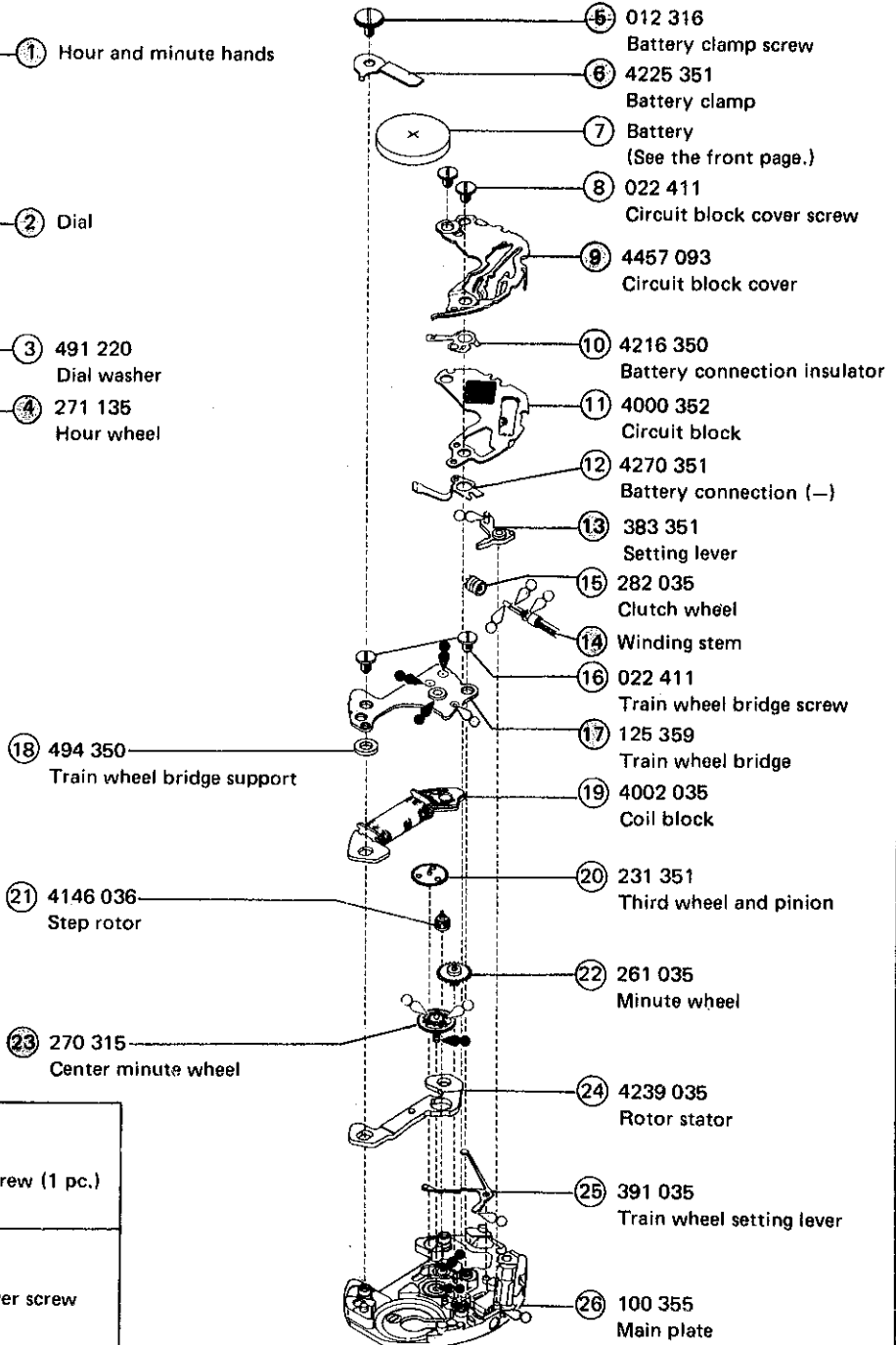
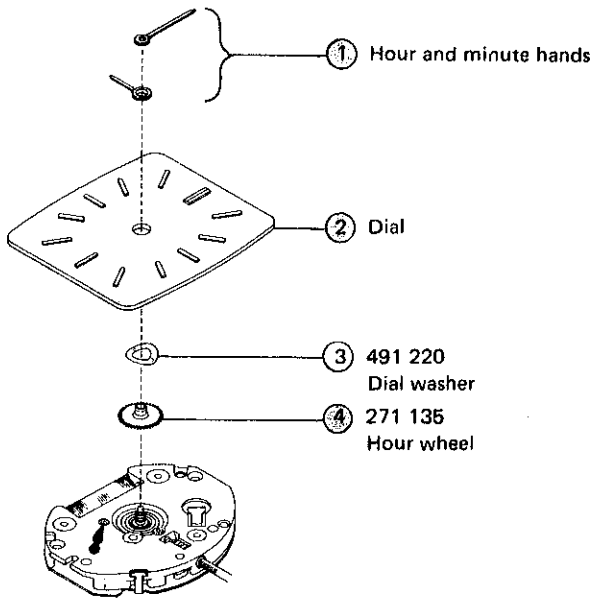
 Moebius A  Normal quantity
 SEIKO Watch Oil S-6

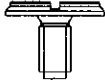

	012 316 Battery clamp screw (1 pc.)
	022 411 Circuit block cover screw (2 pcs.) Train wheel bridge screw (2 pcs.)

 → Please see the remarks on the following pages.





PARTS CATALOGUE

Cal. 2Y00A

Remarks:

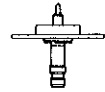
- ④ Hour wheel
- ②③ Center minute wheel

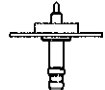
Combination:

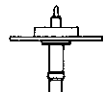
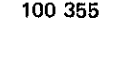
Type	Hour wheel	Center minute wheel	Main plate (Center part)
a	 271 119	 270 316	 100 355
b	 271 135	 270 315	 100 355
c	 271 139	 270 317	 100 355

- ⑤ Battery clamp screw 012 316
- ⑥ Battery clamp 4225 351

Some models are not provided with the battery clamp and battery clamp screw.

- ⑨ Circuit block cover 4457 093

The spring portion of some circuit block covers is shaped differently in part. Both types, however, can be used interchangeably.

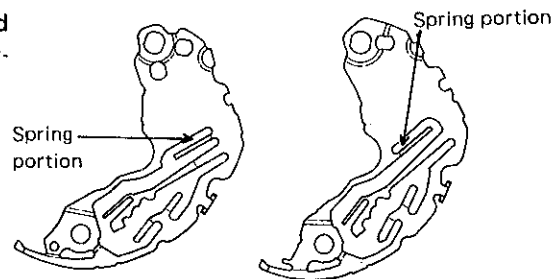

- ⑬ Setting lever 383 351

The setting lever is available in two types: one with a collar and the other without a collar. They can be used interchangeably.

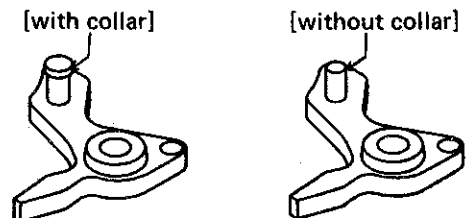

- ⑭ Winding stem 351 236 / 351 238

The type of winding stem is determined based on the design of cases. Check the case number and refer to "SEIKO Casing Parts Catalogue" to choose a corresponding winding stem.

- The explanation here is only for the particular points of Cal. 2Y00A.
- For the repairing, checking and measuring procedures, refer to the "TECHNICAL GUIDE, GENERAL INSTRUCTION".

I. STRUCTURE OF THE CIRCUIT BLOCK

There are two types of circuit block, and they can be used interchangeably.

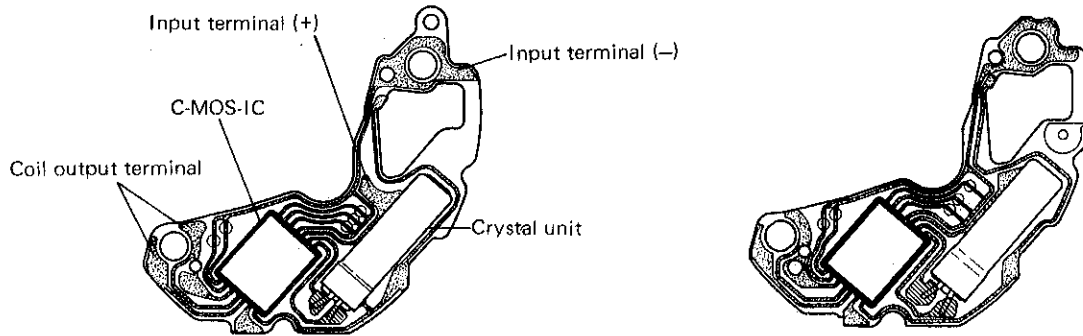

II. REMARKS ON DISASSEMBLING AND REASSEMBLING

Use the universal movement holder for disassembling and reassembling.

① Hands

• Remarks on installing

When installing the hands, place the movement directly on a flat metal plate or the like, escaping the spring portion of the circuit block cover.

② Dial

• How to remove

Insert the tip of a screwdriver into the notch between the main plate and the dial, and remove the dial by prying it up alternately at both ends.

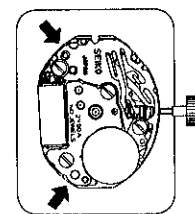

Notch

⑨ Circuit block cover

• How to install

- 1) Push in the winding stem to the normal position.
- 2) Set the circuit block cover so that its hook catches the main plate. (Fig. 1 & 2)
* Do not press the setting lever spring portion at this time.
- 3) Set the hole "A" of the circuit block cover onto the guide pin and hook the yoke portion to the protrusion of the setting lever. (Fig. 1 & 3)
* Do not bend the spring portion excessively.
- 4) Set the hole "B" of the circuit block cover securely onto the guide pin and tighten the two circuit block cover screws.

Fig. 1

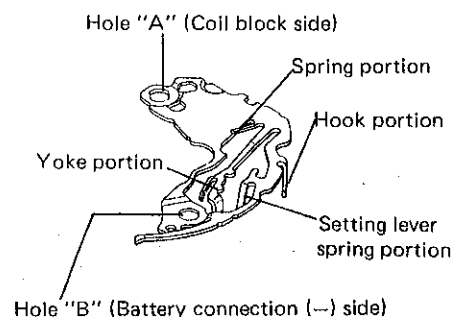

Fig. 2
Back view

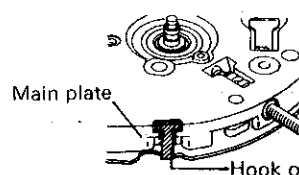
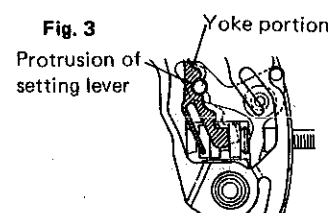

Fig. 3



⑭ Winding stem

● **Remarks on installing**

To prevent any crack onto the main plate, gently set the winding stem while turning it.

⑰ Train wheel bridge

● **Setting position**

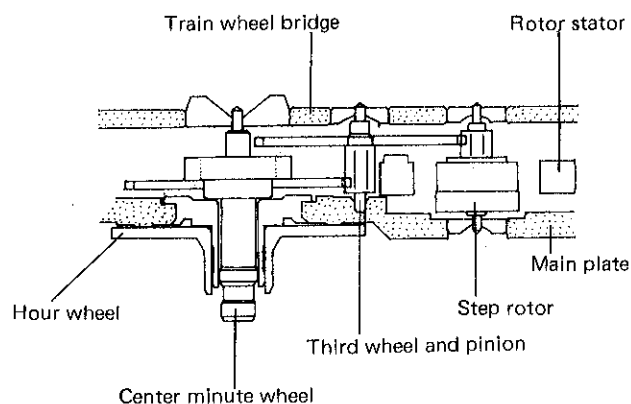

III. VALUE CHECKING

● **Coil block resistance**

2.1K Ω ~ 2.6K Ω

● **Current consumption**

For the whole of the movement: less than 0.4 μ A

For the circuit block alone : less than 0.3 μ A

Remarks:

When the current consumption exceeds the standard value for the whole of the movement but is less than the standard value for the circuit block alone, overhaul and clean the movement parts and then measure current consumption for the whole of the movement again. The driving pulse generated to compensate a heavy load that may apply on the gear train, etc. is considered to cause excessive current consumption for the whole of the movement.