

TECHNICAL GUIDE

SEIKO

DIGITAL QUARTZ

Cal. 0644A & 0664A

CONTENTS

| | |
|--|----|
| I. SPECIFICATIONS AND FEATURES | 1 |
| 1. Specifications | 1 |
| 2. Features | 1 |
| II. OPERATING METHOD | 2 |
| 1. Display and buttons | 2 |
| 2. How to set the time | 2 |
| 3. How to use the light | 2 |
| III. DISASSEMBLING AND REASSEMBLING | 3 |
| 1. After-sale servicing instruments and materials | 3 |
| 2. Disassembling and reassembling of case | 4 |
| (1) Cal. 0664A | 4 |
| (2) Cal. 0644A | 6 |
| 3. Disassembling and reassembling of movement | 8 |
| (1) Cal. 0664A | 8 |
| (2) Cal. 0644A | 10 |
| 4. Cleaning | 12 |
| IV. CHECKING AND ADJUSTMENT | 13 |
| 1. Guide table for checking and adjustment | 13 |
| 2. Malfunction and checking points | 14 |
| 3. Segment and C-MOS-LSI output terminal | 15 |
| 4. Practical checking and adjustment | 16 |
| A: Check battery voltage | 16 |
| B: Check contact of C-MOS-LSI and liquid crystal panel | 16 |
| C: Check liquid crystal panel and circuit block | 17 |
| D: Check current consumption | 17 |
| E: Check accuracy | 17 |
| F: Time accuracy adjusting | 18 |
| G: Check hour and minute setting, second digit condition | 19 |
| H: Check switch components | 19 |
| I: Check bulb condition | 20 |
| • PARTS LIST | 21 |

I. SPECIFICATIONS AND FEATURES

External view of watch complete

Cal. 0664A



Cal. 0644A



1. Specifications

| Item | Calibre | 0664A & 0644A |
|-------------------------------|---------|--|
| Display system | | 12-hour digital display system showing hour, minute and second |
| Display medium | | Single Crystal Display, Nematic Liquid Crystal, FEM (Field Effect Mode) |
| Crystal oscillator 3 | | 32,768 Hz (Hz = Hertz = cycles per second) |
| Loss/gain | | Loss/gain at normal temperature range Mean monthly rate: Less than 10 seconds (Annual rate: Less than 2 minutes) |
| Casing diameter | | φ 27.00 mm |
| Height | | 8.5 mm |
| Operational temperature range | | -10°C ~ +60°C (14°F ~ 140°F) |
| Regulation system | | Trimmer condenser |
| Battery power | | Silver oxide battery (U.C.C. 386) Battery life is over one year. |
| IC (Integrated Circuit) | | C-MOS-LSI 1 piece Hybrid IC 1 piece |

2. Features

- (1) The crystal oscillator generates a highly stabilized oscillation.
- (2) Extensive minimization of the movement and simplified blocks of each component facilitate after-sale servicing.
- (3) Single Liquid Crystal developed by SEIKO is used for display medium, which enables a very clear digit to be displayed on the panel.
- (4) Digital display system indicates the time clearly (even in seconds).
- (5) Illuminating light enables the time to be read in the dark.
- (6) Time adjusting is done simply by the Selection and Setting system developed by SEIKO.
- (7) Lock switch prevents the time adjusting button from being pushed by mistake.

II. OPERATING METHOD

1. Display and buttons

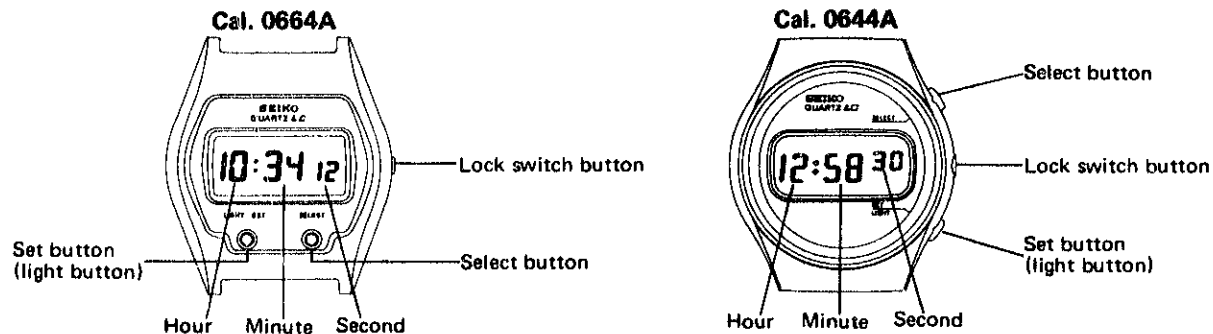

2. How to set the time

| | Procedure | Cal. 0664A | Cal. 0644A |
|------------------------------|---|------------|------------|
| How to set the second digits | (1) Pull out the lock switch button. The second digits will start flashing. This indicates that the second digits are ready to be adjusted. | | |
| | (2) Depress the set button in accordance with the "00" second of a time signal and the seconds are then reset to "00" and start immediately. (When the seconds count any numbers from "30" to "59" and the set button is depressed, one minute is added and the seconds immediately return to "00".) | | |
| How to set the minute digits | (3) Depress the select button. The minute digits will start flashing. This indicates that the minute digits are ready to be adjusted. | | |
| | (4) Depress the set button. One minute is advanced by each depression of the set button. Repeat depression until the desired minute digits are displayed. | | |
| How to set the hour digits | (5) Depress the select button. The hour digits will start flashing. This indicates that the hour digits are ready to be adjusted. | | |
| | (6) Depress the set button. One hour is advanced by each depression of the set button. Repeat depression until the desired hour digits are displayed. | | |
| Completion of time setting | (7) Push in the lock switch. When the time setting is completed, be sure to push the lock switch button in. | | |

3. How to use the light

Depress the light button, and the illuminating light is lit while it is depressed.
It illuminates the digital display in the dark.

12:34 56

12:34 56

III. DISASSEMBLING AND REASSEMBLING

1. After-sale servicing instruments and materials

For after-sale servicing of SEIKO Quartz Digital Cal. 0664A & 0644A, the following after-sale servicing instruments and materials are necessary.

(1) Quartz Tester QT-10 and QT-100

Used to check time accuracy (daily rate).
The microphone is different, however, for QT-10 and QT-100.

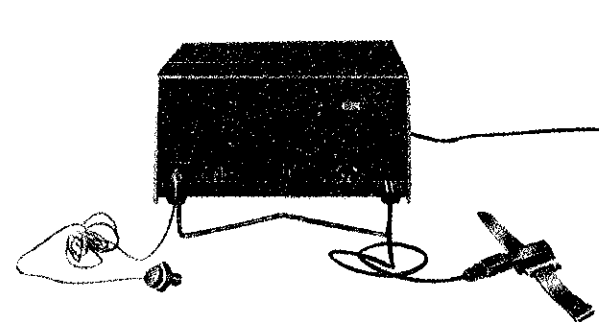

• Electric-field detection microphone for QT-10.

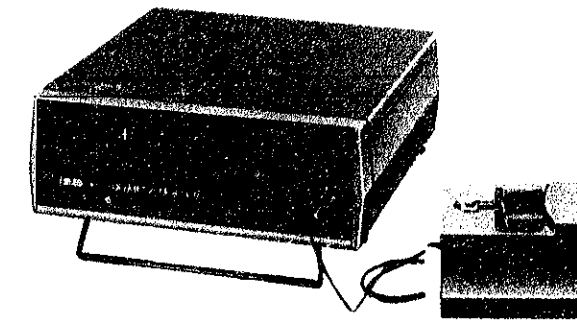

• Oscillation detection microphone for QT-100.

(2) Volt-ohm-meter

Used to check battery voltage and measure current consumption.

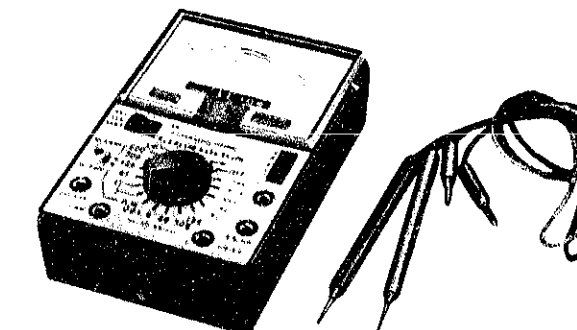

(3) Movement holder

Used for disassembling and reassembling of the movement.



(4) Battery holding spring

Used for securing battery and flowing current when the movement is removed from the case.



(5) Static electricity protector S-830

Used to protect the circuit block from being damaged by static electricity.



2. Disassembling and reassembling of the case

(1) Cal. 0664A (0664-5000)

Disassembling procedures Figs.: ① ~ ⑩

Reassembling procedures Figs.: ⑩ ~ ①

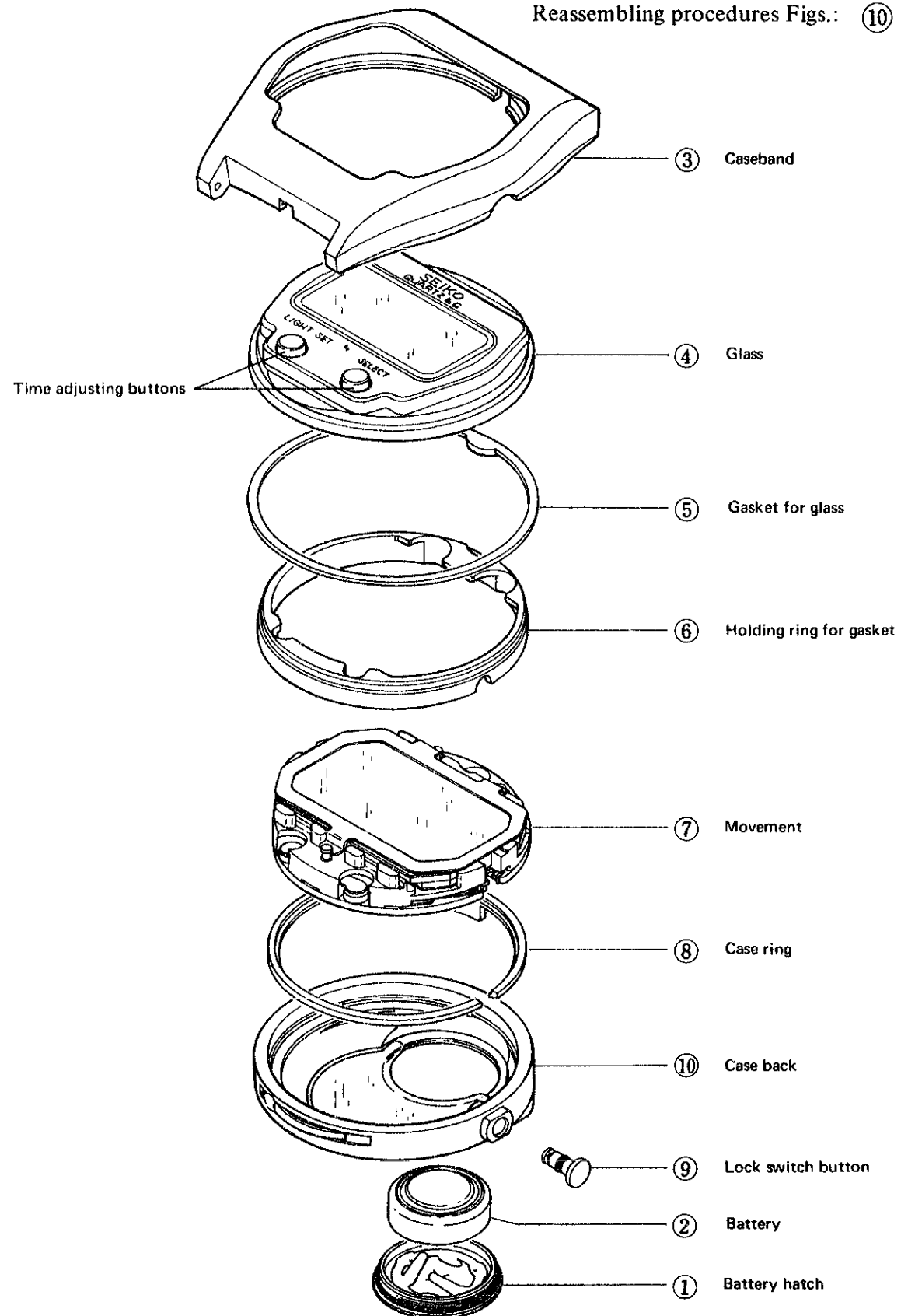

REMARKS FOR DISASSEMBLING AND REASSEMBLING

Remarks for disassembling

- Movement ⑦
Hold the battery guard with tweezers and remove the movement.

Remarks for reassembling

- Movement ⑦
After reassembling the movement, check to see if the lock switch button can be pulled out and pushed back and functions correctly.
- Gasket for glass ⑤
Be sure to set the gasket in position with its flat side down.

Remarks for disassembling and reassembling

- Glass ④
Be careful not to scratch the printed inner surface of the glass with tweezers.

(2) Cal. 0644A (0644-8000)

Disassembling procedures Figs.: ① ~ ⑮

Reassembling procedures Figs.: ⑮ ~ ①

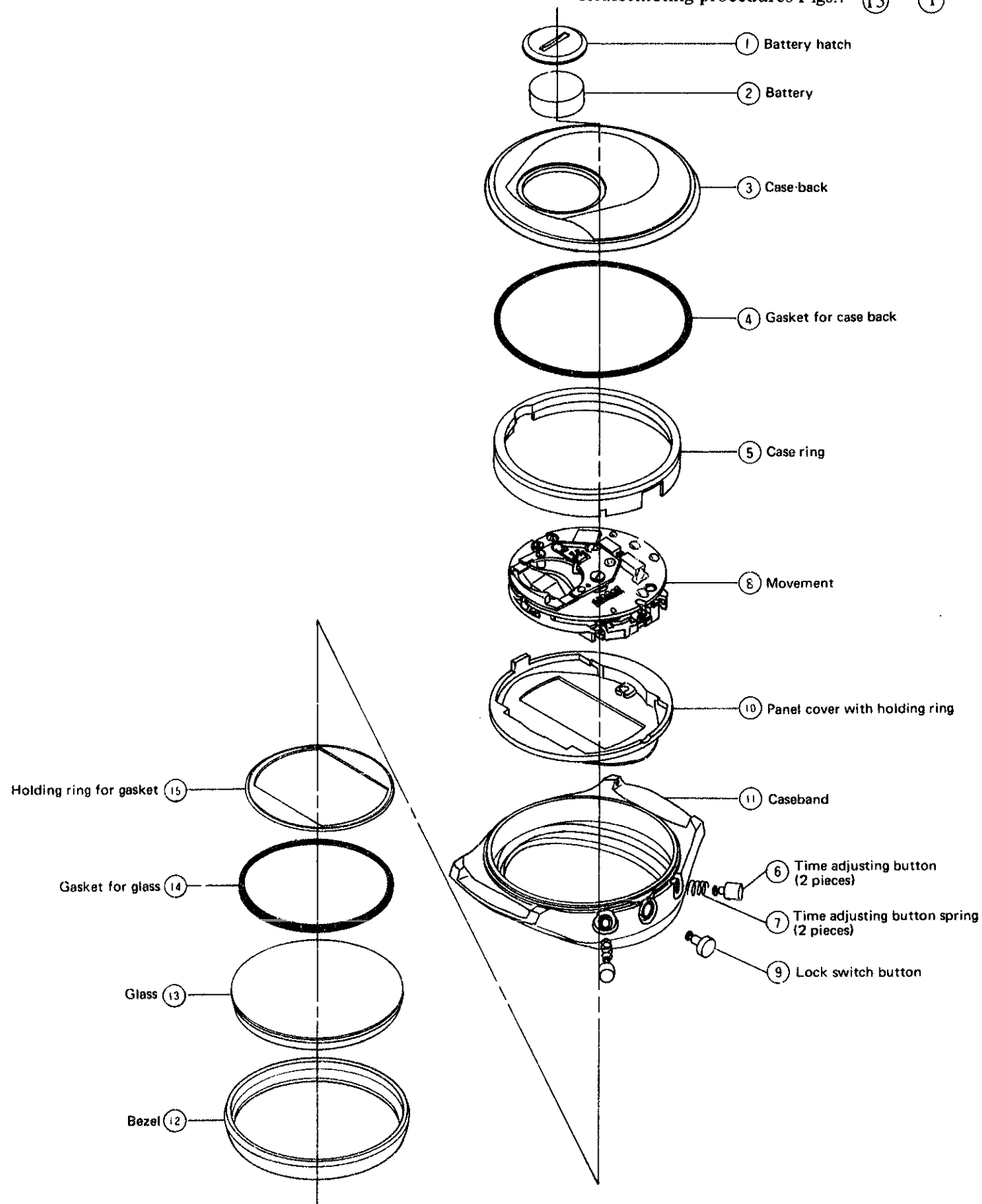

REMARKS FOR DISASSEMBLING AND REASSEMBLING

Remarks for disassembling

- **Case ring ⑤**
Depress the two time adjusting buttons by fingers and remove the case ring with tweezers. Otherwise, the time adjusting button and its spring will spring out.
- **Movement ⑧**
Hold the battery guard with tweezers, and remove the movement.
- **Panel cover with holding ring ⑩**
As the panel cover and the panel holding ring make up one combined part, it is not necessary to disassemble them.

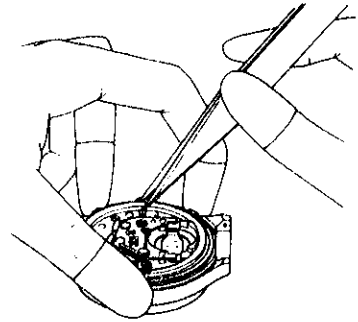

Remarks for reassembling

- **Movement ⑧**
Before reassembling, get the setting lever in a "pulled out" position. After reassembling the movement, check to see if the lock switch button can be pulled out and pushed back and functions correctly.
- **Case ring ⑤**
Depress the two time adjusting buttons by fingers and reassemble the case ring. (See the illustration above.)
- **Case back ③**
Bring the line of both alignment notch on the case back and caseband and push the case back in.

3. Disassembling and reassembling of the movement

(1) Cal. 0664A

Disassembling procedures Figs.: ① ~ ⑨

Reassembling procedures Figs.: ⑨ ~ ①

Lubricating ∞: SEIKO Watch Oil S-6, normal quantity

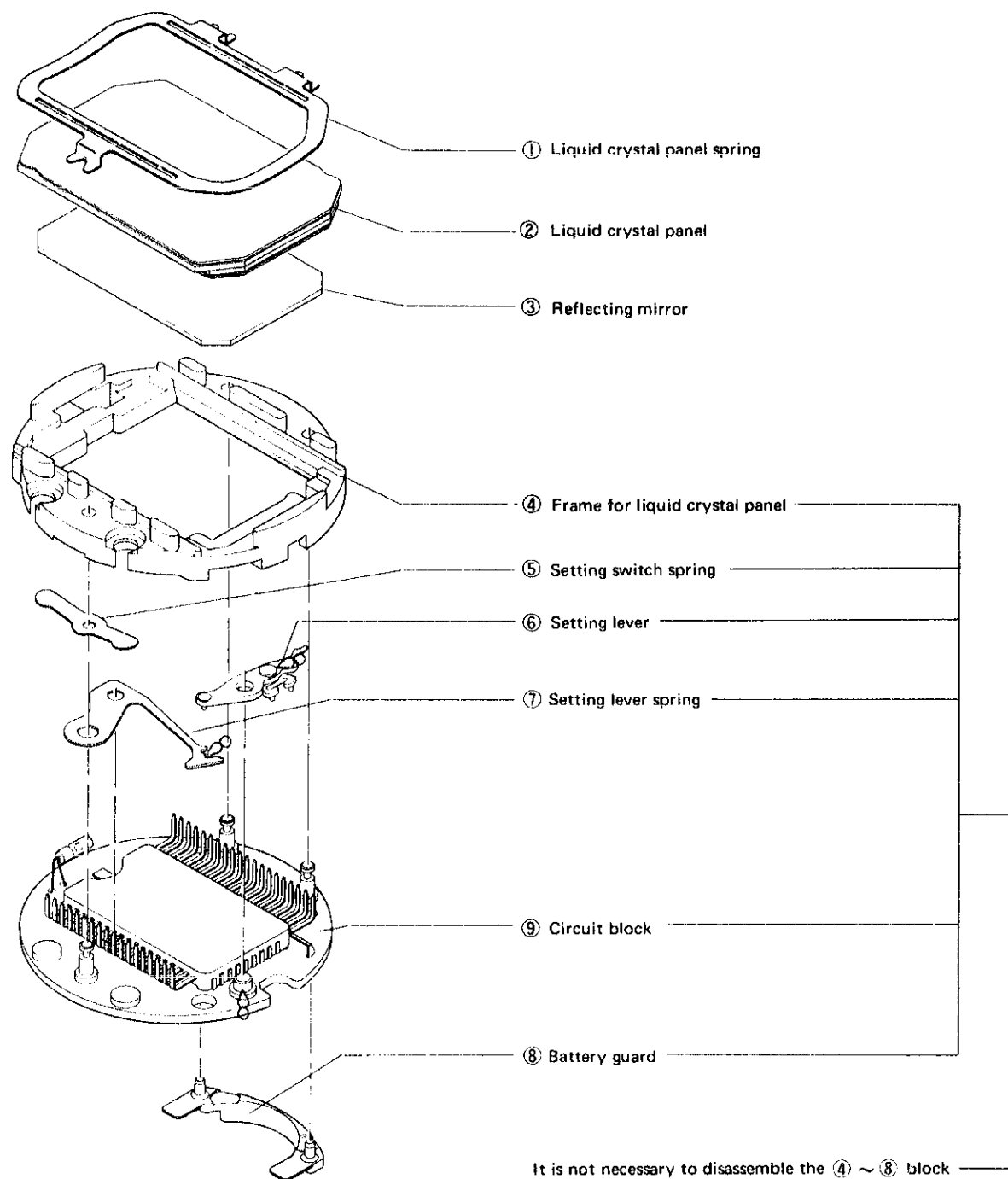

It is not necessary to disassemble the ④ ~ ⑧ block except in case of any damage.

REMARKS FOR DISASSEMBLING AND REASSEMBLING

Remarks for disassembling

- Frame for liquid crystal panel ④
 In order to remove the frame for liquid crystal panel, insert a tip of tweezers into the side of the guide pins (3 pcs.) for the frame for the liquid crystal panel, and pry up the frame evenly as shown in the illustration.

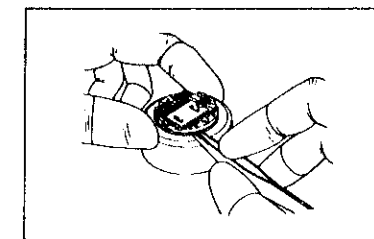

Remarks for reassembling

- Setting switch spring ⑤
 Make sure to assemble it in the correct direction.
- Frame for liquid crystal panel ④
 ■ Hold it horizontally and push in slowly.

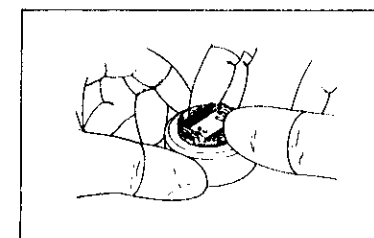
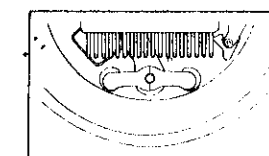
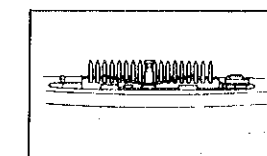

- Be careful not to bend the C-MOS-LSI terminal by pushing on the frame for liquid crystal panel.

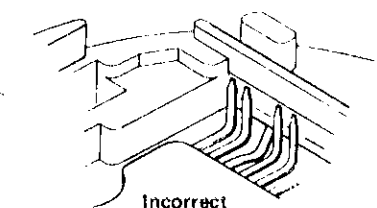
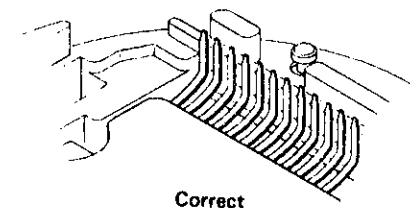

- Before reassembling the frame for liquid crystal panel, check to see if the terminals of the bulb do not touch each other.

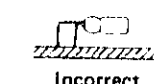
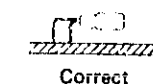

- When reassembling the frame for liquid crystal panel, be careful not to break the bulb.

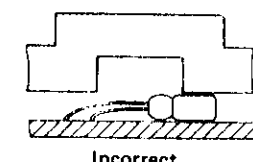
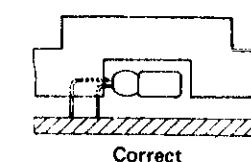

- After reassembling the frame for liquid crystal panel, check the bulb position. If the bulb position is low, raise it with tweezers.

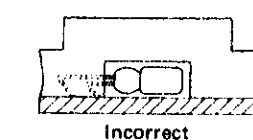
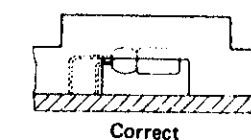

Remarks for disassembling and reassembling

- Setting lever ⑥
 Be careful not to bend the thin spring.
- Battery guard ⑧
 It is not necessary to remove the battery guard from the circuit block except in case of any damage.

• Circuit block ⑨

It is recommended to connect the battery to the circuit block with the battery holding spring when the circuit block is handled, for this is effective to prevent the circuit block from being damaged by static electricity.

(2) Cal. 0644A

Disassembling procedures Figs.: ① ~ ⑮
 Reassembling procedures Figs.: ⑮ ~ ①
 Lubricating ∞ : SEIKO Watch Oil S-6, normal quantity.

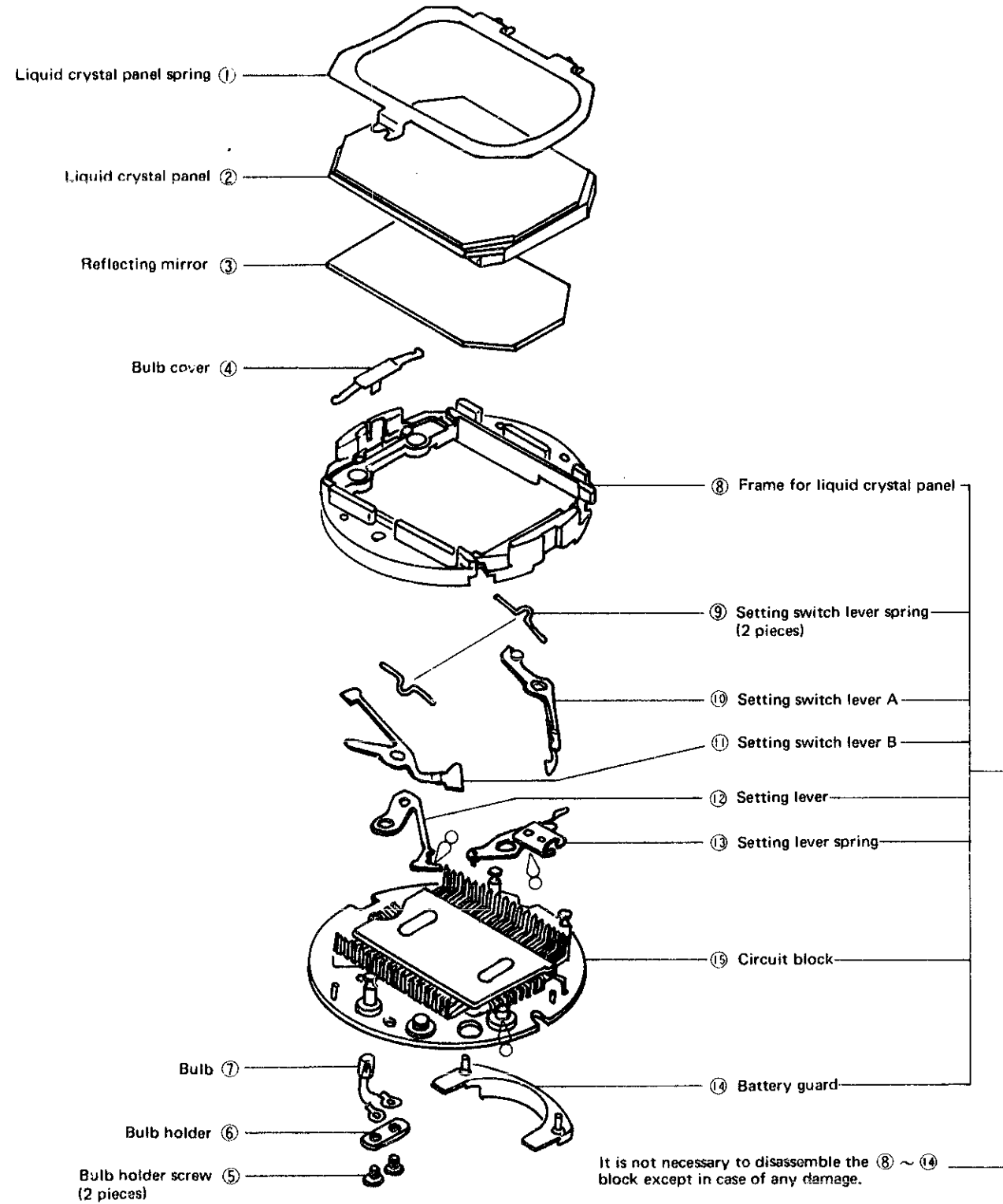

REMARKS FOR REASSEMBLING

As the remarks listed below do not include those remarks common to Cal. 0664A, please refer to the remarks for Cal. 0664A also.

• Setting switch lever spring ⑨

When reassembling the setting switch lever A, be careful not to bend the setting switch lever spring which is easy to be bent, and follow the procedures below.

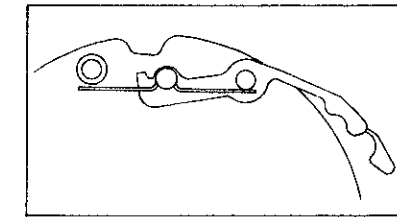

Set the spring in position.

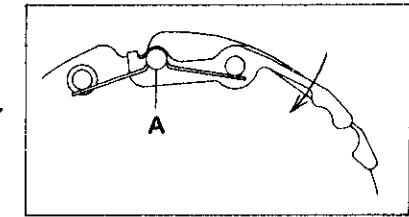

Depress the setting switch lever A in the arrow-marked direction, until part A reaches the dent of the circuit board. When it reaches, hook the extended part A on the dent.

• Bulb ⑦

The lead terminals of the spare bulb are not bent for reassembling. Bend the terminals with tweezers as shown in the illustration.

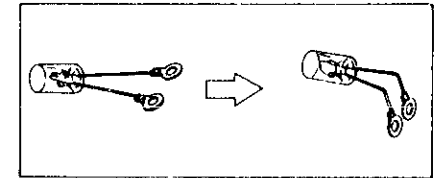

• Bulb holder screw ⑤

Tighten the screws firmly. After tightening the screws, make sure that the lead terminals of the bulb do not touch with each other.

• Bulb cover ④

- Before assembling the bulb cover, check the bulb position. The top of the bulb (a) should not be lower than the notch (b) of the frame for the liquid crystal panel. If it is low, correct the position by pulling it up with tweezers.
- Hook the bulb cover pawl to the frame for the liquid crystal panel as shown in the illustration.

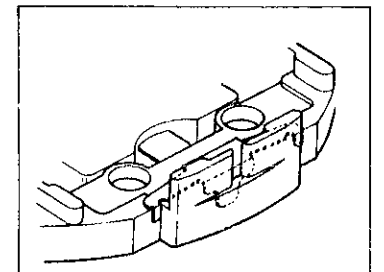
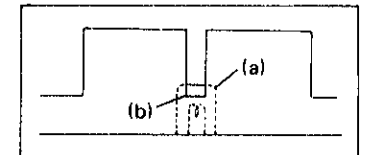

4. Cleaning

Since several parts (electronic and plastic parts) of Cal. 0644A and 0664A differ from those of the conventional mechanical watches, use the following method when cleaning.

HOW TO CLEAN

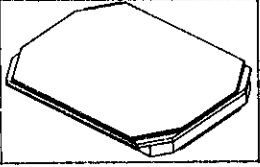
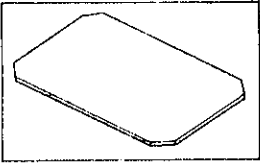
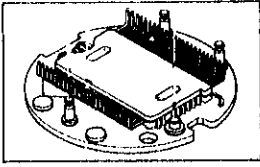
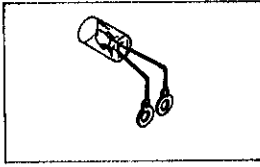
| Name of parts | Cleaning | Drying | Solution | Remarks |
|---|-----------------------------|------------------------|--|--|
| Liquid crystal panel  Reflecting mirror  Circuit block  Bulb (Cal. 0644)  | DO NOT CLEAN | | | <ul style="list-style-type: none"> Wipe dust and lint with a soft brush. Wipe the electrodes and contacts of liquid crystal panel and circuit block and the reflecting mirror with a cloth moistened with benzine. Be careful not to scratch the aluminum-evaporated face of the reflecting mirror. |
| Plastic parts | Rinse or clean with a brush | Cool air | Alcohol or Benzine | |
| Parts other than above (Metal parts) | | Cool or hot air drying | Trichloro-ethylene, benzine or alcohol | When cleaning the setting lever, be careful not to bend the thin spring. |

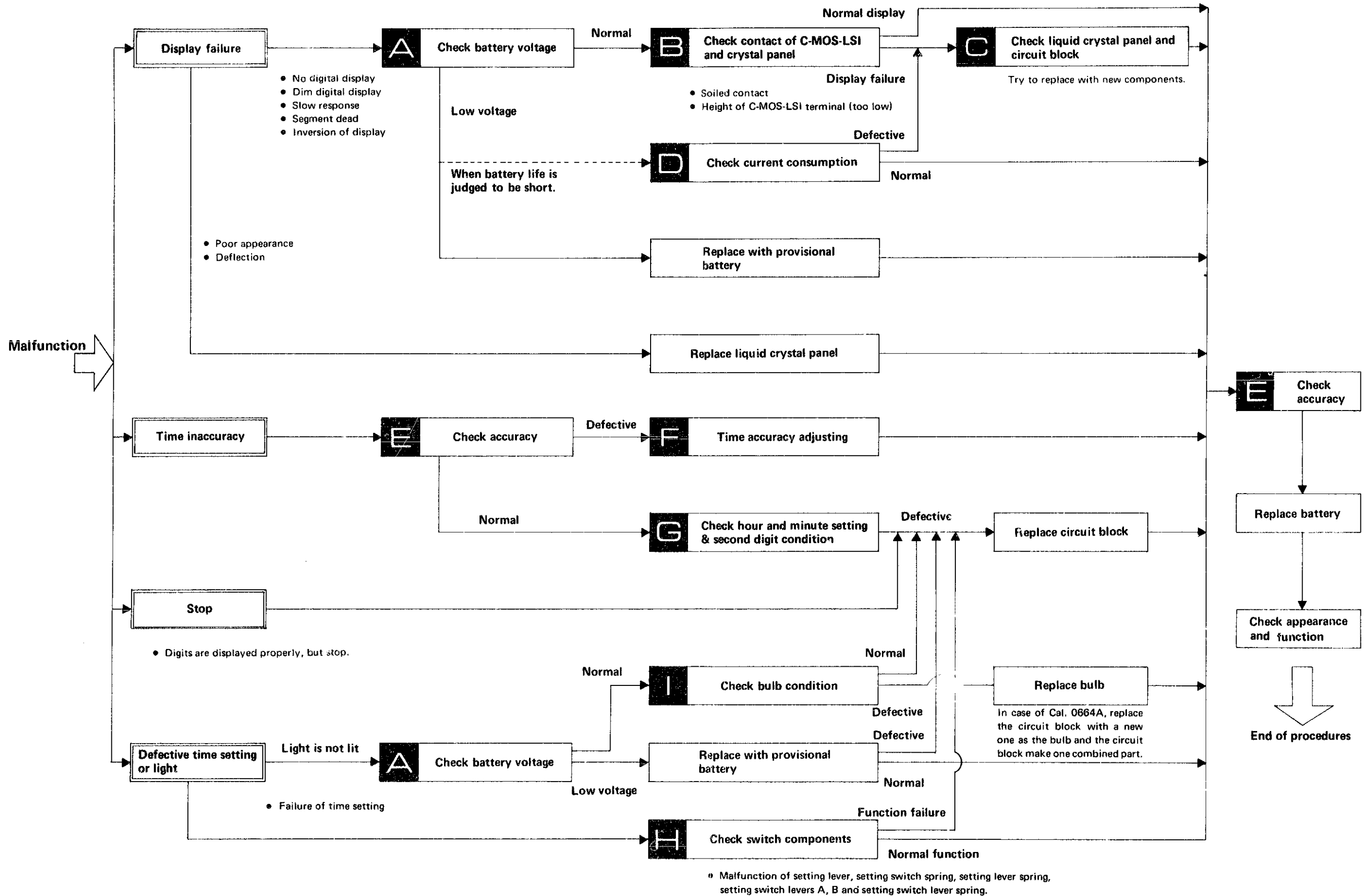

IV. CHECKING AND ADJUSTMENT

1. Guide table for checking and adjustment

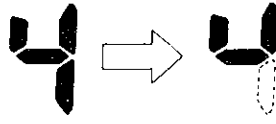
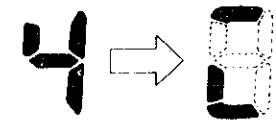

2. Malfunction and checking points

- Check in the numerical order.
- Refer to "Guide table for checking and adjustment" on page 13.

| FAULTY SYMPTOMS | | CHECKING POINTS | | | | | | | |
|---|---|-----------------|---|----------------------|---------------|-------------------------|--|-------------------|------|
| | | A | B | C | | F | G | H | I |
| | | Battery voltage | Contact of C-MOS-LSI and liquid crystal panel | Liquid crystal panel | Circuit block | Time accuracy adjusting | Check hour and minute setting and second digit condition | Switch components | Bulb |
| Display failure | No digital display, dim digital display or extremely slow response | ① | | ② | ③ | | | | |
| | (Segment dead) One or a few segments are not lighted or dim. Example:  | | ① | ② | ③ | | | | |
| | (Inversion of display) The segments which are to be lighted are turned off, or the segments which should not be lighted are turned on. Or all segments are turned on. Example:  | | ① | ② | ③ | | | | |
| | (Deflection) Some or all of one segment show different contrast depending on the direction of view. Example:  (Poor appearance) Some portions of the liquid crystal panel will make air bubbles or iridescent view. Example:  Air bubbles | | | ① | | | | | |
| Time inaccuracy | Gain or loss tested by Quartz tester. | | | | | ① | | | |
| | Though Quartz tester indicates the normal figures, a watch gains or loses when it is worn on the wrist. | | | | ② | | ① | | |
| Defective time setting or light | Light is not lit or light is lit but dims soon. | ① | | | ④ | | | ③ | ② |
| | Failure of time setting. | | | | ② | | | ① | |
| Stop (Digits are displayed properly, but stop.) | | | | | ① | | | | |

3. Segment and C-MOS-LSI output terminal

A complete knowledge of how the segment (Electrode of Liquid Crystal Panel) works with the C-MOS-LSI Output Terminal will provide the proper procedures for checking and adjusting.

(1) Segment

- Identification of the digit

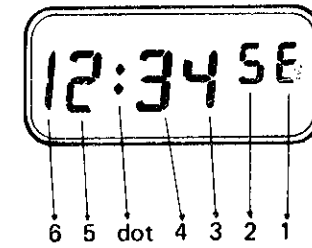

- Segment

One digit consists of seven (7) segments.



Example:

The segment in ○ is called "4d."

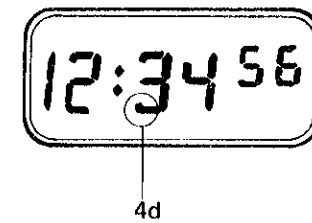

(2) Connection with C-MOS-LSI

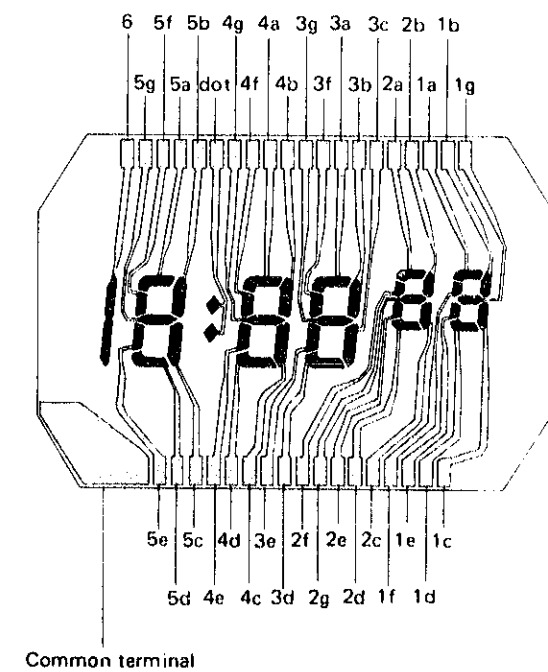
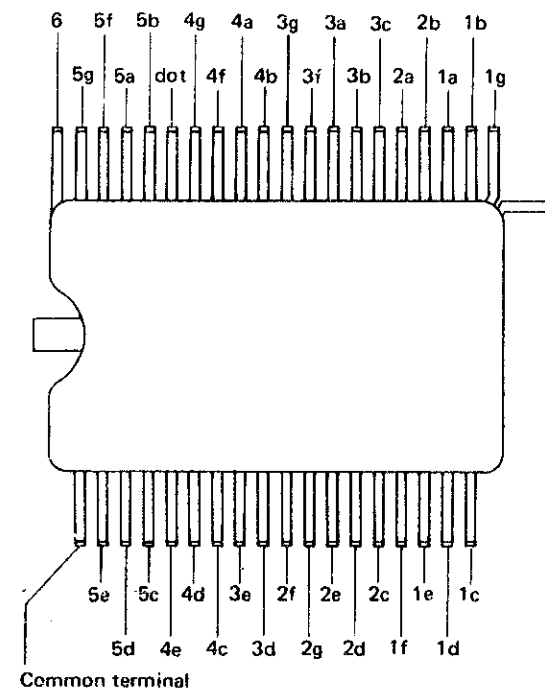

4. Practical checking and adjustment

A Check battery voltage

Use the following procedures to check battery voltage.

- (1) Set up the Volt-ohm-meter
Range to be used: DC 3 V

(2) Measuring

- Probe Red (+) Battery surface (+)
- Probe Black (-) Battery surface (-)

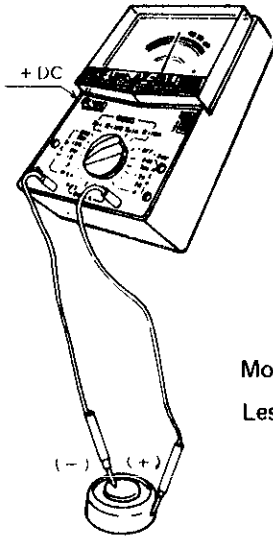

More than 1.5 V . . . Normal
Less than 1.5 V . . . Defective

B Check contact of C-MOS-LSI and liquid crystal panel

Set up the battery with the battery holding spring before checking.

After removing the liquid crystal panel, check the conductivity of the electrode of the liquid crystal panel and C-MOS-LSI output terminals.
(See page 15 for "Segment and C-MOS-LSI output terminal".)

- (1) Check to see if there is any contamination on the liquid crystal panel electrodes and the C-MOS-LSI output terminal.

No foreign matter . . . Normal
Foreign matter . . . Defective
Wipe off any foreign matter.

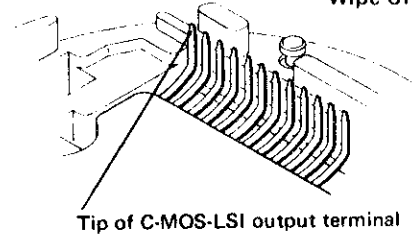
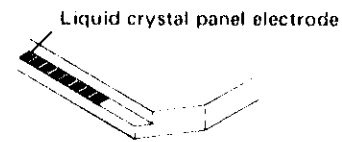

- (2) Check contact conditions by examining the height of the C-MOS-LSI output terminals to see if they are too low.

Raise, with tweezers, the tips of the C-MOS-LSI output terminal to connect the liquid crystal panel electrodes of these segments until the segments light up.

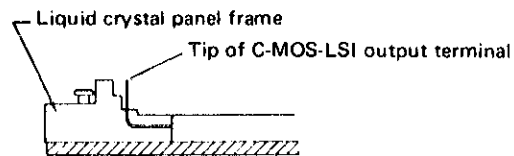

- After assembling the liquid crystal panel, check to see if the segments light up.

Light up Normal
Do not light up . . . Defective
. Proceed to



C Check liquid crystal panel and circuit block

After replacing the liquid crystal panel or the circuit block, check to see if the watch works correctly.

D Check current consumption

Check to see if the current consumption is normal in the following conditions.

- Time function

- (1) Lock switch button at the normal position
- (2) Lock switch in the pulled out position

- Volt-ohm-meter

Range to be used: DC 0.03 mA

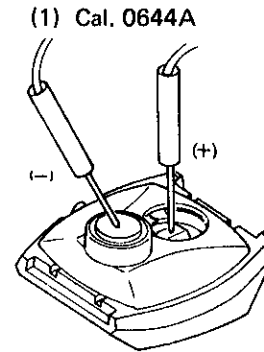

Probe Red (+) Battery lead terminal (+)
Probe Black (-) Battery surface (-)

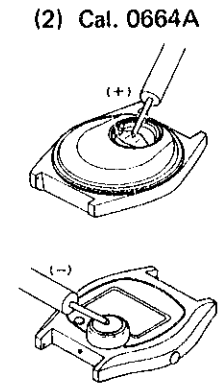

Less than 6 μ A . . . Normal
More than 6 μ A . . . Defective

E Check accuracy

- Use the electric-field detection microphone for QT-10.
(See "How to use Quartz Tester QT-10" of the Technical Guide for Cal. 0624A, page 6.)
- Use oscillation detection microphone for QT-100.

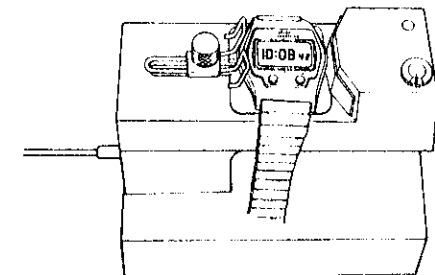
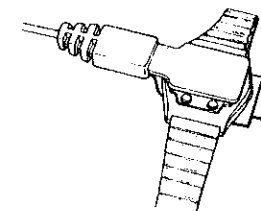

F Time accuracy adjusting

Time accuracy of Cal. 0664A & 0644A is adjusted by turning the trimmer condenser.

• **Adjusting method**

The watch will gain or lose according to the direction in which the trimmer condenser is turned. Adjustment should therefore be made after ascertaining with the Quartz Tester whether the watch tends to gain or lose.

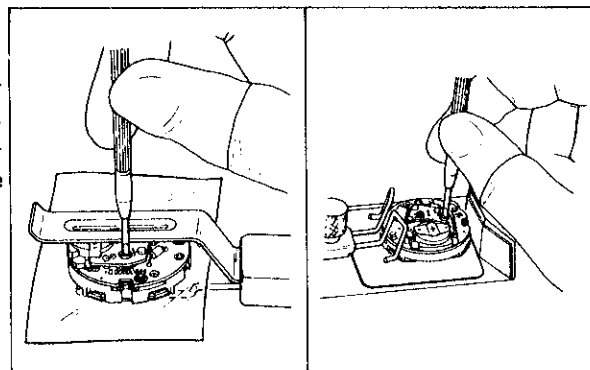

• **Note for handling the trimmer condenser**

Avoid excessive depressing and turning of the trimmer condenser.

• **Function of the Trimmer Condenser**

The trimmer condenser consists of a rotor electrode and a stator electrode as shown in the diagram. Turning the shaft fixed to the rotor changes the overlapped area between the stator electrode and rotor electrode, which in turn changes the capacity of the trimmer condenser.

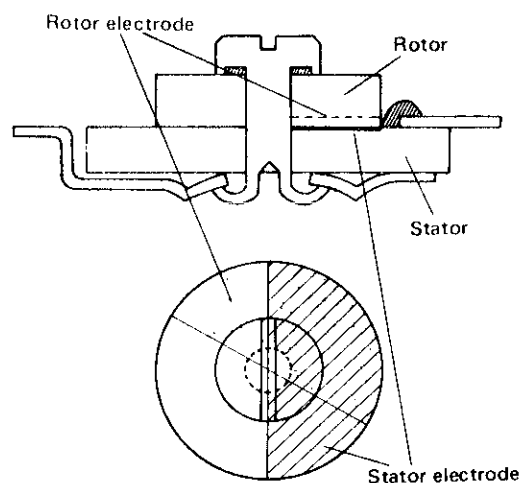

• **Change in the capacity of trimmer condenser and the adjusting accuracy rate.**

Turning the trimmer condenser changes its capacity as shown in the diagram.

The trimmer condenser has been adjusted at the factory so as to let the watch gain when it is turned clockwise and vice versa. Whenever adjustment is needed, however, turn the trimmer condenser while examining the gain and loss by the Quartz Tester.

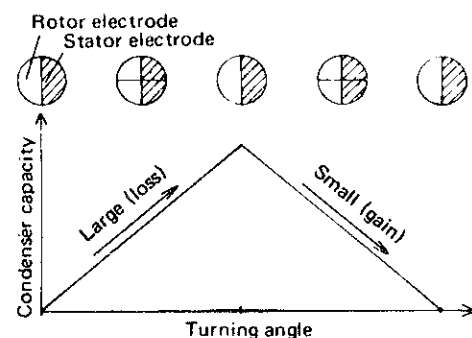

G Check hour and minute setting, second digit condition

(1) Check the second digit condition.

- Check if the digit appears exactly at every second for more than one minute.

(2) Check if the hour and minute setting is made precisely. (See "How to Set the Time" on page 2)

- Minute setting condition More than 60 minutes
- Hour setting condition More than 12 hours

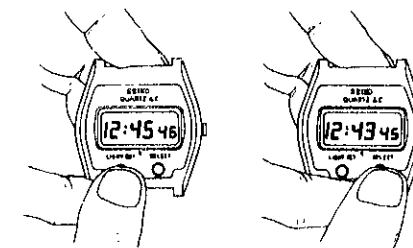

H Check switch components

Check to see if the lock switch button and the time adjusting buttons work correctly.

(1) Check to see if the lock switch button functions correctly. (Cal. 0664A, 0644A)

- Check to see that the thin spring of the setting lever touches the unlock terminal when the lock switch button is pulled out, and that the thin spring of the setting lever is set apart from the unlock terminal when the lock switch button is pushed in.

Remarks:

- Make sure that there is no foreign matter (dust, lint, etc.) on the thin spring of the setting lever and unlock terminal contacts.

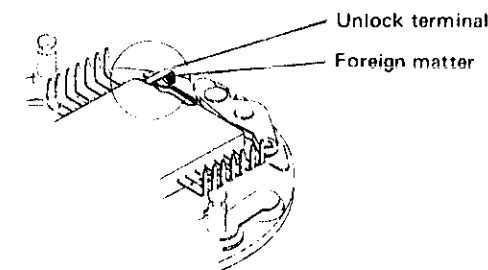

(2) Check to see if the setting button functions correctly.

[1] Cal. 0664A

- Check to see if the setting switch spring touches the pin of the circuit board as shown in the illustration. If it touches, correct it with tweezers.

Remarks:

- Make sure that there is no foreign matter (dust, lint) between the setting switch spring and the pin of the circuit board. Wipe off dust and lint if there is any.

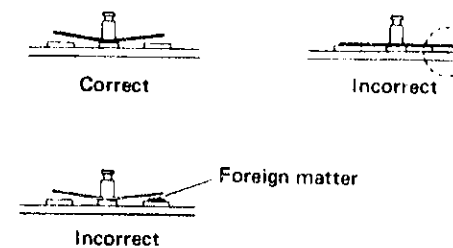

[2] Cal. 0644A

- Make sure that part "a" of the setting switch lever A touches pin "a" when the select button is depressed and that the part "a" is set apart from the pin "a" when the select button is released.
- Make sure that part "b" of the setting switch lever B touches pin "b" when the set button is depressed and that the part "b" is set apart from the pin "b" when the set button is released.

Remarks:

- Check to see if there is no foreign matter on the contact points of the setting switch levers A and B and the respective pins. Wipe off foreign matters if there is any.

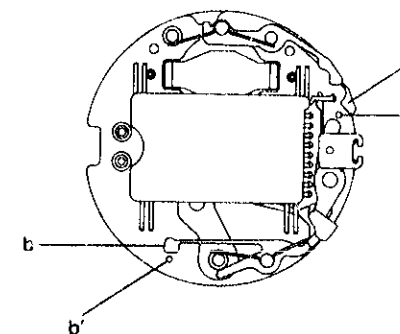

PARTS LIST

Check bulb condition

1. Check to see if the bulb lead terminals touch with each other.



Not touched: Correct



Touched: Incorrect . . . Adjust the lead terminals of the bulb with tweezers.

2. Check to see if the bulb filament is burnt out.

(1) Set up the Volt-ohm-meter.

Range to be used: OHMS R x 1

(2) Checkup

Touch two probes of the tester to the bulb holder screws or the bulb lead terminals as shown in the illustration.

Note: Either black or red probe is allowed to touch both screws.

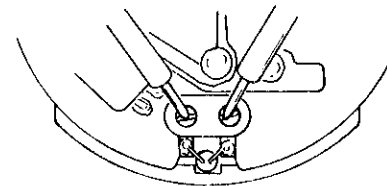

Light up Normal

Not light up Defective . . . In case of Cal. 0644A, replace the bulb.

When replacing the bulb of Cal. 0664A, replace the circuit block as bulb is soldered to the circuit block.

Remarks for replacement of bulb for Cal. 0644A

1. Bend the lead terminals before reassembling.

As the bulb furnished for after-sale servicing has straight terminals, bend the terminals with tweezers as shown in the illustration.

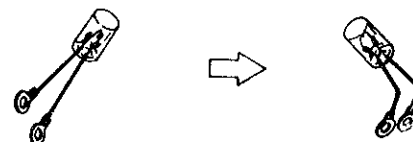

2. Keep the bulb as high as possible for effective illumination.

The higher the bulb, the brighter the display panel.

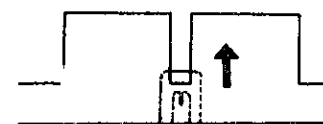

All procedures of Disassembling, Reassembling Checking and Adjusting are completed.

| Movement Parts | | | | Casing Parts | | | |
|--|--------------------------|---------|----------|-----------------------------------|---------------------------------|-------------------|------------------------|
| Cal. | 0624A (Basic Calibre) | 0664A | 0644A | Cal. | 0624A (Basic Calibre) | 0664A | 0644A |
| Part Name | | | | Part Name | | | |
| Circuit block | 4001646 (4001645) | 4001669 | 4001665 | Case | 0624-5009 (SS) (SGP) | 0664-5000 (SS) | 0644-8000 (SS) |
| Liquid crystal panel | 4501660 (4501649) | 4501680 | 4501660 | Glass | REOV22GNT | ESOW22AM | 320W32GN |
| Frame for liquid crystal panel | 4408649 | 4408652 | 4408660 | Panel cover | 86169971 | - | 0644-8000 0644-8010 |
| Spring for liquid crystal panel | 4540649 | 4540644 | 4540660 | Holding ring for gasket | 86099821 | 86099681 | 86099704 86099694 |
| Reflecting mirror | 4521643 | 4521680 | 4521660 | Lock switch button | 80610449 | 80610629 | 80610529 |
| Setting lever | 383649 | | 383644 | Time adjusting button | 80610429 (SS) 80600181 (SGP) | 80610709 | 80610549 |
| Setting switch spring (*Setting switch lever spring) | 4245649 | | *4238660 | Gasket for glass | - | DZ2944B | EZ2990B |
| Setting switch lever A | - | | 4450660 | Gasket for case back | FH3094B | - | 0B3100B |
| Setting switch lever B | - | | 4450661 | Gasket for battery hatch | FM1250B | | |
| Bulb (with terminal) | - | | 4032660 | Gasket for lock switch button | DJ0060B | | |
| Bulb holder screw | - | | 022494 | Gasket for time adjusting button | DJ0060B | | |
| Bulb cover | - | | 4531660 | Push pin | A1801S | A1901S | A1801S |
| Setting lever spring | 782649 | 782643 | | Bezel | - | | |
| Battery guard | 4398649 | | | Case ring | 83108030 | 83108020 | 83107851 |
| Bulb holder | - | | 4532660 | Hook-up for time adjusting button | 734503 | | |
| Silver oxide battery | U.C.C. 386 | | | Holding ring for dial | - | | |
| | | | | Time adjusting button spring | - | | |
| | | | | Battery hatch | 83599829 | | |

Remarks: The mark (-) in each column indicates that the described parts are not used.