

**SEIKO**

QUARTZ *LC*  
CHRONOGRAPH

**(Cal.0634A)**

**PARTS LIST**

Calibre No.

0634A

Jewels

0j

Style Name

QUARTZ LC  
CHRONOGRAPH

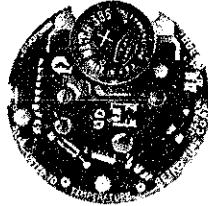
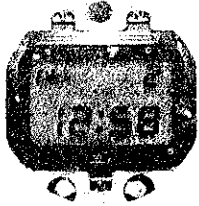

Characteristics

Casing diameter: 27.00  $\phi$  mm  
Maximum height: 8.50 mm  
Frequency of quartz crystal oscillator: 32,768 Hz  
(Hz = Hertz . . . . . Cycle per second)

Watch functions: 12-hour Digital Display System showing hour and minute

The dots blink once every second.

Date, AM and PM display

Stopwatch functions: 60-min. Digital Display System showing minute, second and 1/10 second with lapse time measuring device

Display medium:

Single Crystal Display (Nematic Liquid Crystal, FE-type)

Time micro-adjustor: Trimmer condenser system

Illumination light for digital display panel:

Illuminated in coordination with the touch-button depressing



383 649



782 643

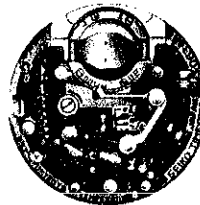

4001 651



4245 649



4398 649

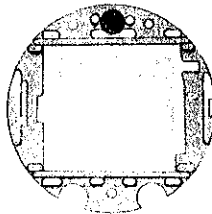

4408 644

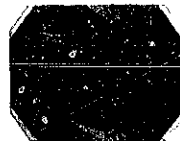

4501 651



4521 643

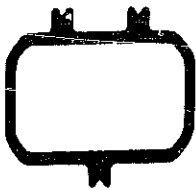

4540 644



U.C.C. 386

λ

Calibre No. <b>0634A</b>		Jewels <b>0j</b>	Style Name <b>QUARTZ LC CHRONOGRAPH</b>	
PART NO.	PART NAME	PART NO.	PART NAME	
<b>383 649</b>	Setting lever			
<b>782 643</b>	Setting lever spring			
<b>4001 651</b>	Circuit block			
<b>4245 649</b>	Setting switch spring			
<b>4398 649</b>	Battery guard			
<b>4408 644</b>	Frame for liquid crystal panel			
<b>4501 651</b>	Liquid crystal panel			
<b>4521 643</b>	Reflecting mirror			
<b>4540 644</b>	Spring for liquid crystal panel			
<b>U.C.C.386</b>	Silver oxide battery			

# TECHNICAL GUIDE

## SEIKO

## DIGITAL QUARTZ

CAL.0634A

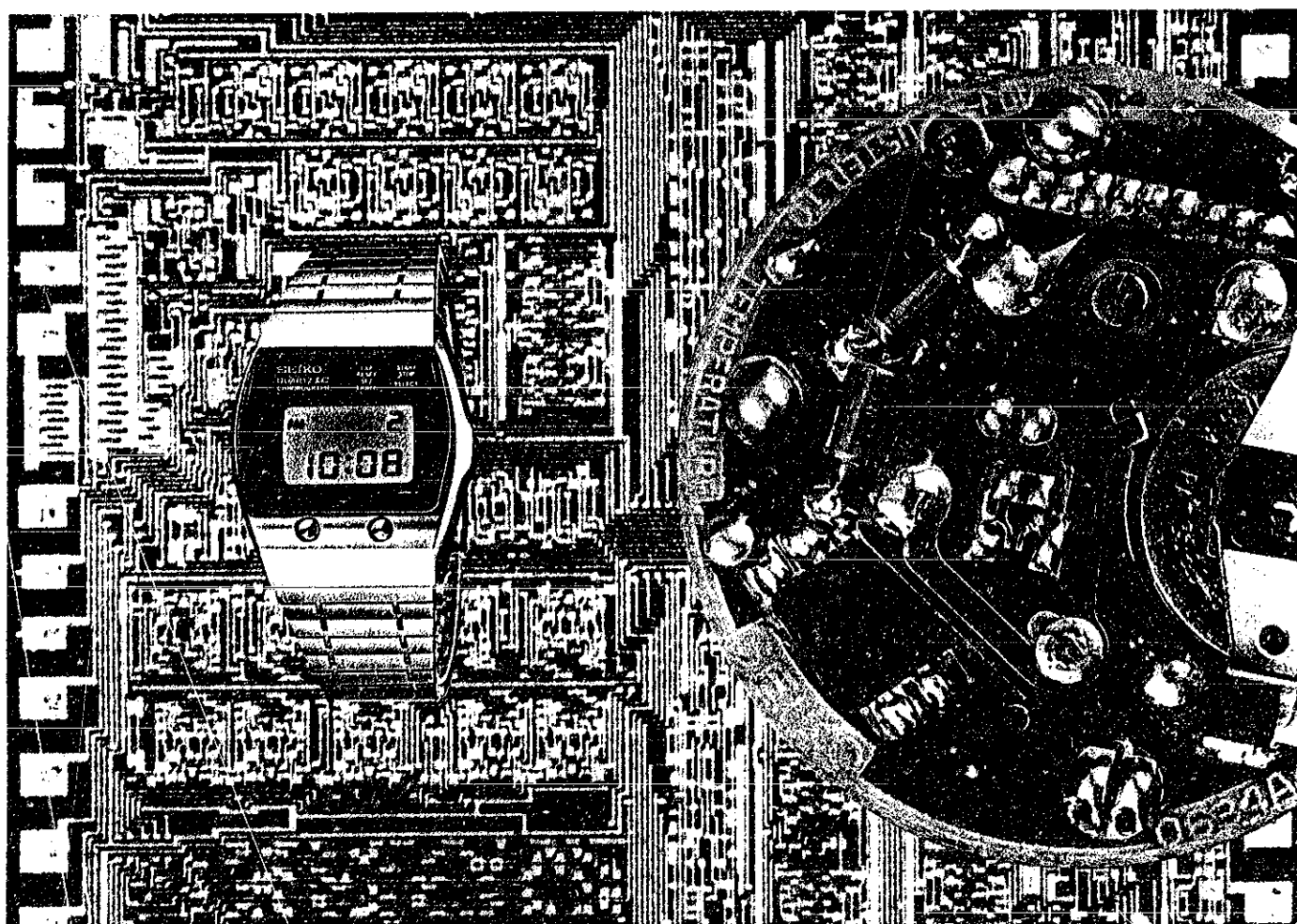

### CONTENTS

I. Specifications and Features .....	1
1. Specifications .....	1
2. Features .....	1
II. How to set the time and date and how to use as a stopwatch .....	2
1. How to set the time and date .....	2
2. How to use as a stopwatch .....	3
3. Remarks for battery replacement .....	3
III. Disassembling and reassembling .....	4
1. Disassembling, reassembling of the movement and lubricating of the switch components .....	4
2. Cleaning .....	5
IV. Checking and adjustment .....	7
1. Guide for checking and adjustment .....	7
2. Explanation of malfunction .....	8
3. Segment and MOS-IC output terminal .....	9
4. Checking and adjustment .....	10
A. Check battery voltage .....	10
B. Check contact of MOS-IC and liquid crystal panel .....	10
C. Check liquid crystal panel and circuit block .....	11
D. Check current consumption .....	11
E. Check accuracy .....	11
F. Time accuracy adjusting .....	12
G. Check time and date setting, and stopwatch function .....	13
H. Check switch components .....	13

# I. SPECIFICATIONS AND FEATURES

Calibre 0634A

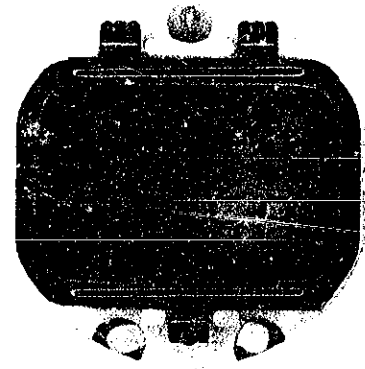

Watch Function

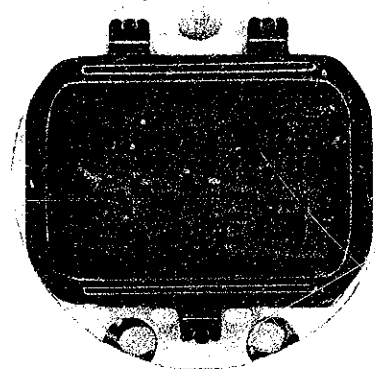

Stopwatch Function

Movement

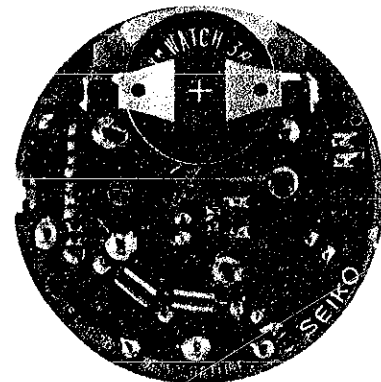

## 1. Specifications

Item	Calibre	0634A
Display system		<ul style="list-style-type: none"> <li>* Watch Functions:—</li> <li>Hour, Minute: 12-hour Digital Display System showing hour and minute</li> <li>Second: The dots blink once every second</li> <li>Date, AM and PM display</li> <li>* Stopwatch Functions:—</li> <li>60-min. Digital Display System showing minute, second and 1/10 second with lapse time measuring device</li> </ul>
Display medium		Single Crystal Display (Nematic Liquid Crystal, FE (field effect)-type)
Operation		Push time adjusting buttons on the front panel: <ul style="list-style-type: none"> <li>* Instant adjusting device of date, hour and minute by selection and setting system (can be adjusted separately)</li> <li>* Instant second setting device</li> <li>* Illumination light</li> </ul> Changeover side button (changeover switch): <ul style="list-style-type: none"> <li>* Watch operation/stopwatch operation changeover mechanism (For stopwatch operation instructions see page 3)</li> </ul>
Crystal oscillator		32,768 Hz. (Hz. = Hertz . . . cycles per second)
Loss/gain		Loss/gain at normal temperature range Mean monthly rate: less than 10 seconds (Annual rate: less than 2 minutes) Temperature compensation device
Casing diameter		27.00 mm $\phi$
Height		8.5 mm
Operational temperature range		-10°C ~ +60°C (14°F ~ 140°F)
Regulation system		Trimmer condenser
Battery power		Silver oxide battery (U.C.C. 386) Battery life is over one year
IC (integrated circuit)		C-MOS-LSI . . . 2 pcs. Hybrid-IC . . . . 1 pce.

## 2. Features

- (1) It is a chronograph designed for optimum effectiveness, incorporating both the watch and stopwatch functions of the digital display system which are the results of SEIKO's highly developed electronic, liquid crystal and precision technology.
- (2) SEIKO's newly developed, easy-to-handle dual operation changeover display system permits simple changeover of watch operation to and from stopwatch operation. As each system functions independently from each other, the time digital display of the watch or time measurement of the stopwatch is not interrupted even if the changeover switch is depressed during use.
- (3) Cal. 0634A has all of the excellent qualities of the basic function of Cal. 0624A, and full consideration is given to its easy operation and easy after-servicing.

## II. HOW TO SET THE TIME AND DATE AND HOW TO USE AS A STOPWATCH

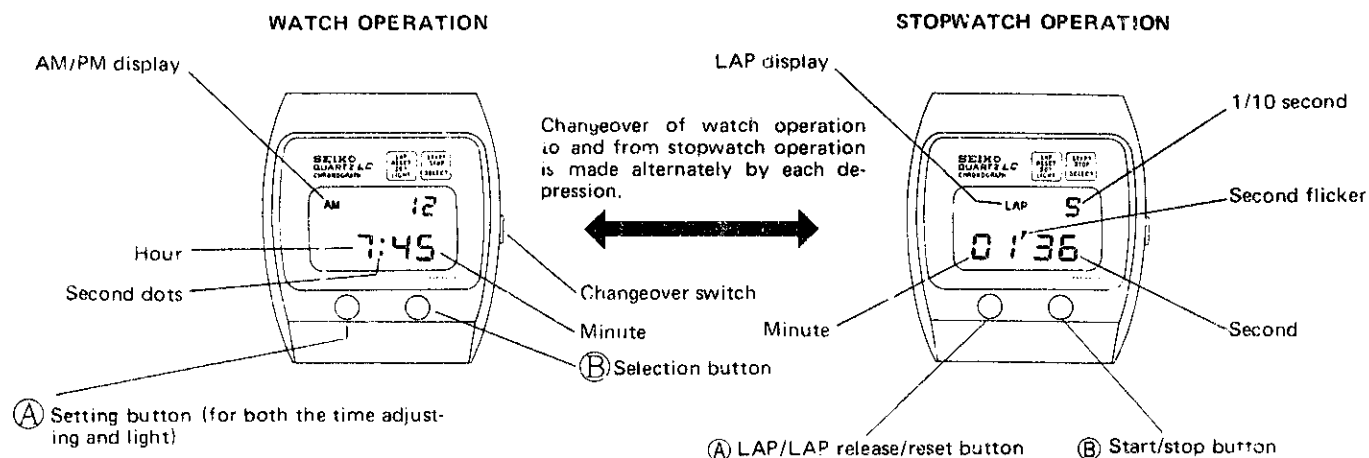

The differences between the watch operation and the stopwatch operation are indicated on the right, showing which system is functioning clearly.

Watch operation	Stopwatch operation
AM/PM display	LAP display (or no display)
: Second dots	'Second flicker
Dots blink once every second	Quick change of 1/10 second digits

### 1. How to set the time and date

The setting of the time and date is basically the same with Cal. 0624A

Pull out the changeover switch and the second dots start blinking twice every second, indicating the second is ready to be adjusted. Firstly, depress the selection button (B) and the date is ready to be adjusted. Then depress button (A) to adjust the date digit. Secondly, depress button (B) and the hour is ready to be adjusted. Then depress button (A) to adjust the hour digit. Thirdly, depress button (B) and the minute is ready to be adjusted. Then depress button (A) to adjust the minute digit.

NOTE: When the second counts any numbers from "00" to "29" the second is reset to "00" automatically whenever button (A) is depressed. When the second counts "30" to "59" and button (A) is depressed, one minute is added and the second immediately returns to "00".

Second setting → Date setting → Hour setting → Minute setting

Ex. How to change the indication of 7:45 AM of the 12th into 12:51:00 PM of the 15th.

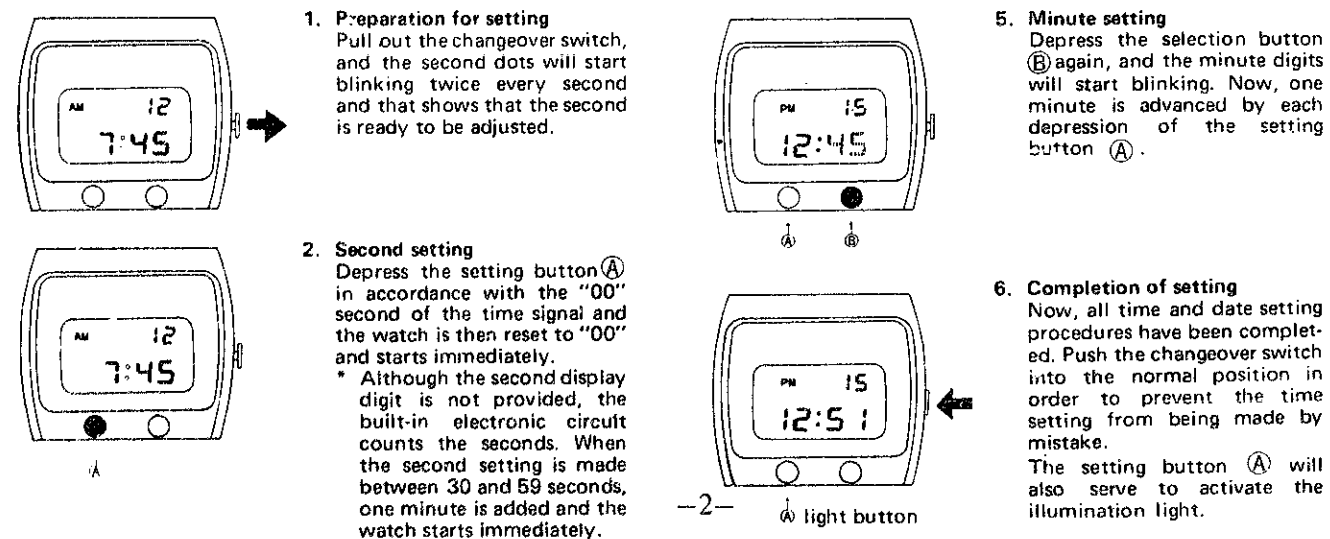

### 2. How to use as a stopwatch

Push the changeover switch in from the watch operation position to the stopwatch operation.

- Be sure to start the stopwatch from its reset condition. (All digits must indicate "0" as shown in the illustration on the right.)  
\* Refer to "How to return the digits to "00" second."

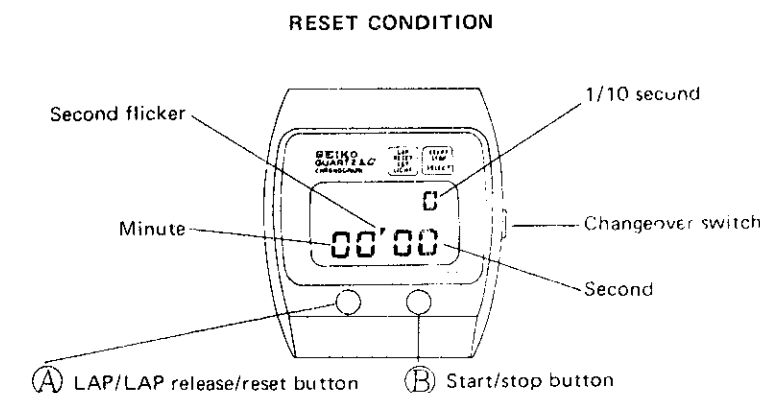

The following four methods of use are available in the stopwatch operation.

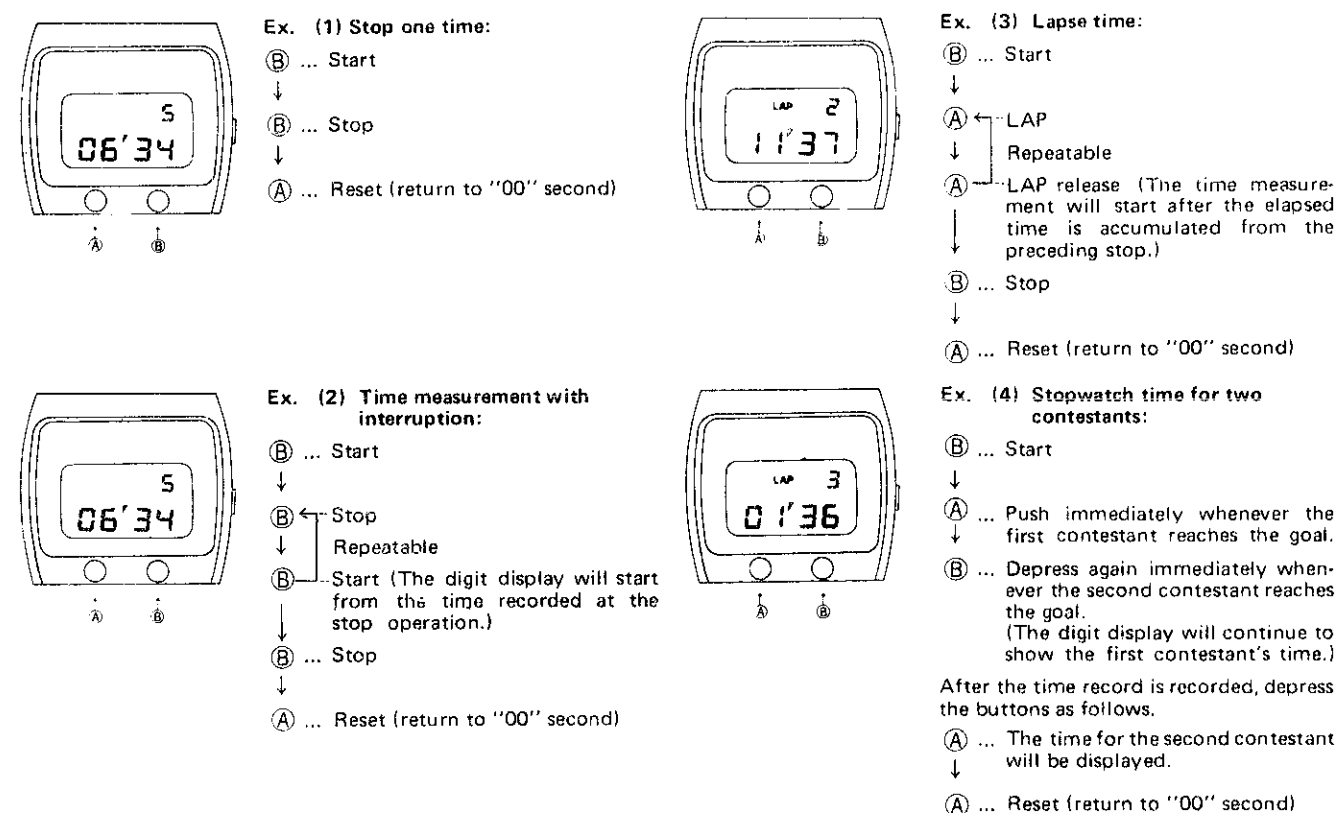

#### How to return the digits to "00" second (Button Operation)

State of display	"LAP" display	"LAP" indicated	"LAP" not indicated
Second flicker is blinking		B → A → A	B → A
Second flicker is not blinking		A → A	A

- The illumination light cannot be used in the stopwatch operation.
- When measuring a long time, it is recommended the stopwatch operation be changed to watch operation after start in order to prevent the buttons from being depressed by mistake.

### 3. Remarks for battery replacement

Incomplete digital figures may be indicated on the display panel after battery replacement. However, this is not a malfunction, the digital figures should be corrected according to the following procedures:

- Try to depress the adjusting button to correct all digital figures in the watch operation.

- Then, change to the stopwatch operation and make digits to "00" second (Reset condition).

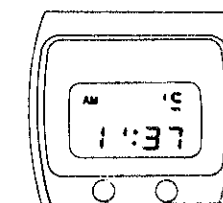

### III. DISASSEMBLING AND REASSEMBLING

#### 1. Disassembling and Reassembling of the movement and lubricating of the switch components



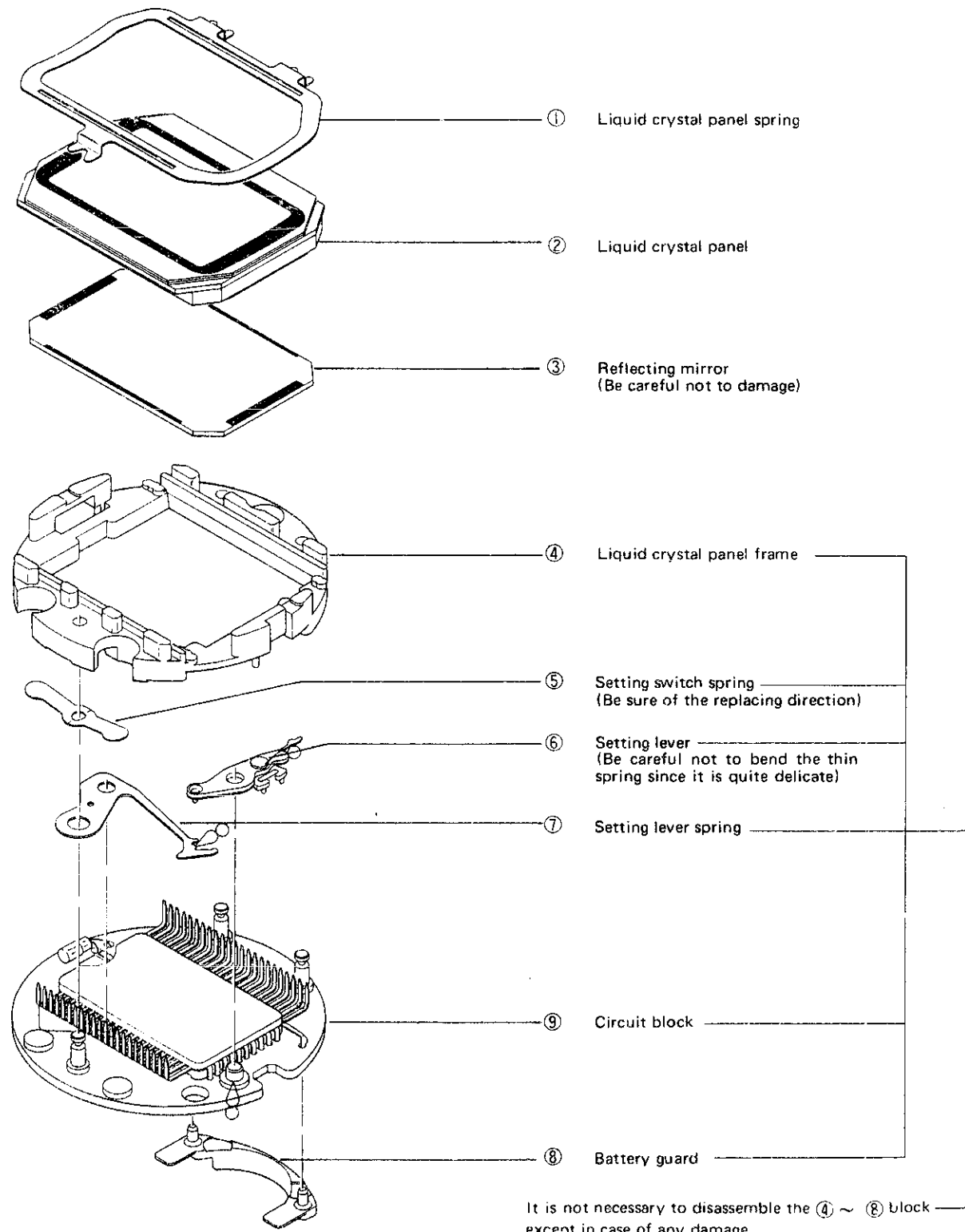

Disassembling procedures Figs.: ① → ⑨  
 Reassembling procedures Figs.: ⑨ → ①  
 Lubricating ∞ : SEIKO Watch Oil, S-6,  
 normal quantity



#### 2. Cleaning

Since several parts of 0634A differ from conventional mechanical watches, use the following method when cleaning.

##### HOW TO CLEAN

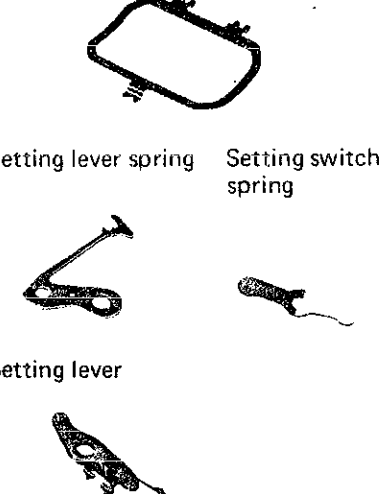
Name of part	Cleaning	Drying	Solution	Remarks
(1) Liquid crystal panel 	DO NOT CLEAN			Wipe the electrode with a cloth moistened with benzine. The other parts should be cleaned with a soft dry brush only.
(2) Circuit block 	DO NOT CLEAN			Wipe dust and lint off the MOS-IC contacts with a soft dry brush. For other contacts, use a cloth moistened with benzine.
(3) Reflecting mirror 	DO NOT CLEAN			Wipe the reflecting mirror with a soft brush or cloth moistened with alcohol if contaminated. Be careful not to scratch the black protective membrane.
(4) Plastic parts Liquid crystal panel frame Battery guard 	Wash with a soft dry brush	Cool air	Alcohol	
(5) Parts other than above Liquid crystal panel spring Setting lever spring Setting switch spring Setting lever 	Wash with a soft dry brush	Cool or hot air drying	Benzine, trichloroethylene	When cleaning the setting lever, be careful not to damage the thin spring.

#### IV. CHECKING AND ADJUSTMENT

##### 1. Guide for checking and adjustment

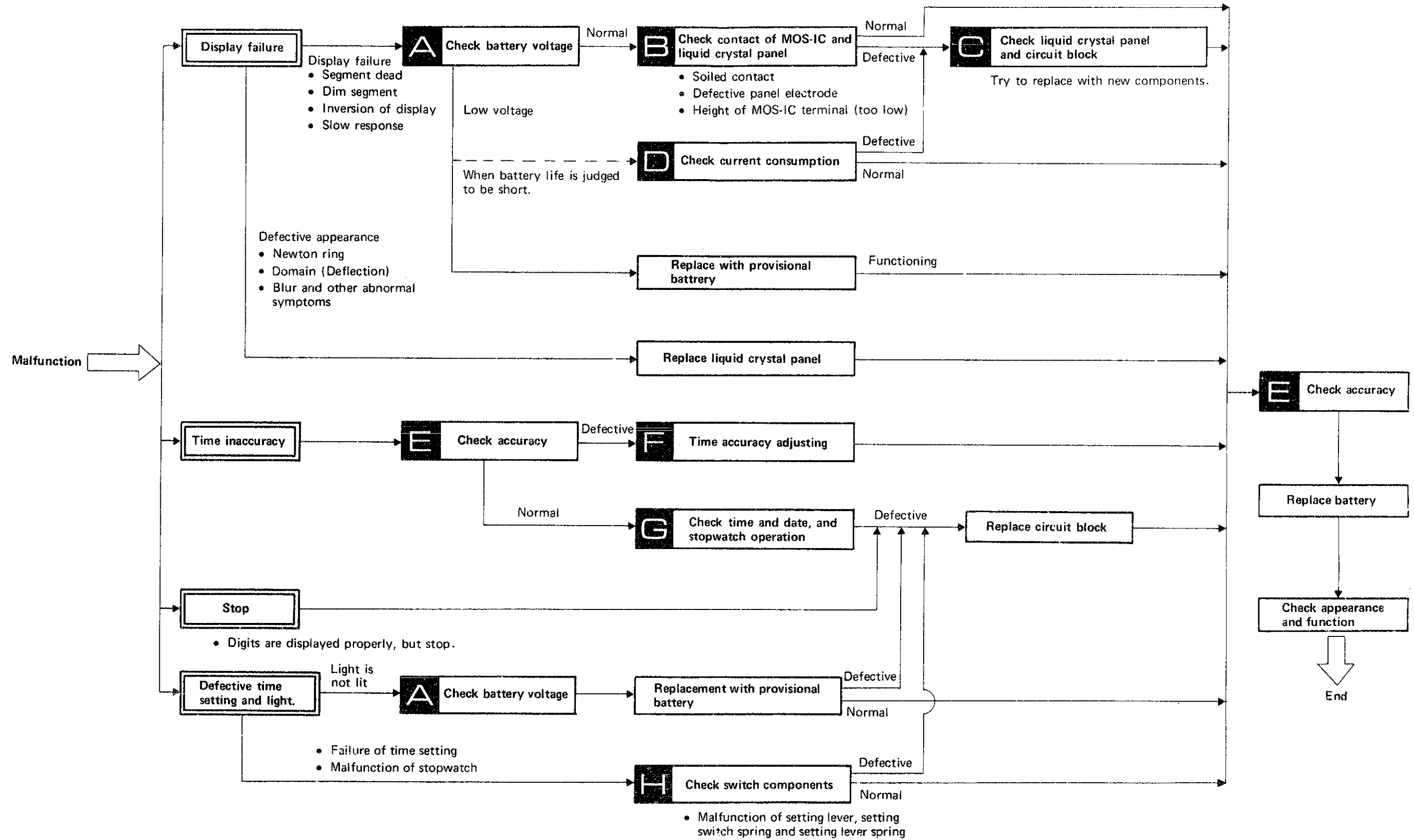

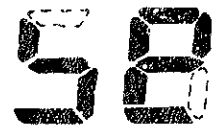
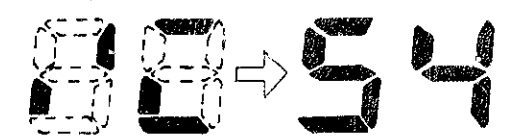
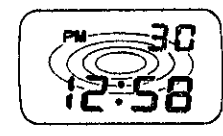
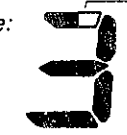
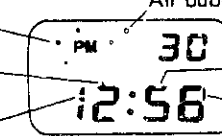

## 2. Explanation of malfunction

Symptom	Explanation
Segment dead	<ul style="list-style-type: none"> <li>The segments which are to be lighted are partially lit or not lighted at all. (They may sometimes light depending on button operation.)</li> </ul> <p>Example: </p>
Inversion of display	<ul style="list-style-type: none"> <li>The segments which are to be lighted are turned off, while the segments which should not be lighted are turned on. Cause: Common terminal is not connected to MOS-IC terminal.</li> </ul> <p>Example: </p>
Slow response	<ul style="list-style-type: none"> <li>On/off operation of segments (to be checked by second or 1/10 second of stopwatch operation) is slow.</li> </ul> <p>Remarks: The response of the liquid crystal panel becomes slow when it is below 0°C but it becomes normal under normal temperatures.</p>
Newton ring	<ul style="list-style-type: none"> <li>The liquid crystal panel turns iridescent.</li> </ul> <p></p>
Domain (Deflection)	<ul style="list-style-type: none"> <li>Some or all of segments show different contrast depending on the direction of view.</li> </ul> <p>Example:  Domain</p>
Poor appearance of display	<p>Black blot, Hairline, Nick, Air bubble, Defacement, Uneven width</p> <p>Note: The reflecting mirror is stained.</p> <p></p>
Time inaccuracy	<p>Though the Quartz Tester indicates the normal digit, a watch gains or losses excessively.</p> <ul style="list-style-type: none"> <li>The circuit block is usually suspected to be faulty. However, check the following before replacing the circuit block.             <ol style="list-style-type: none"> <li>Setting conditions of date, hour and minute:                 <ul style="list-style-type: none"> <li>Date: For more than 31 days;</li> <li>Hour: For more than 12 hours;</li> <li>Minute: For more than 60 min.</li> </ul> </li> <li>Stopwatch function: Start, stop, LAP, LAP release, reset</li> </ol> </li> </ul>
Light will not turn up or dim.	<p>The light is not lit by pushing the light button while the normal time digits are displayed.</p> <p>Remarks: On rare occasions the light will not go on and the digital display goes out while the light button is kept depressed.</p>

### IV. CHECKING AND ADJUSTMENT

#### 1. Guide for checking and adjustment

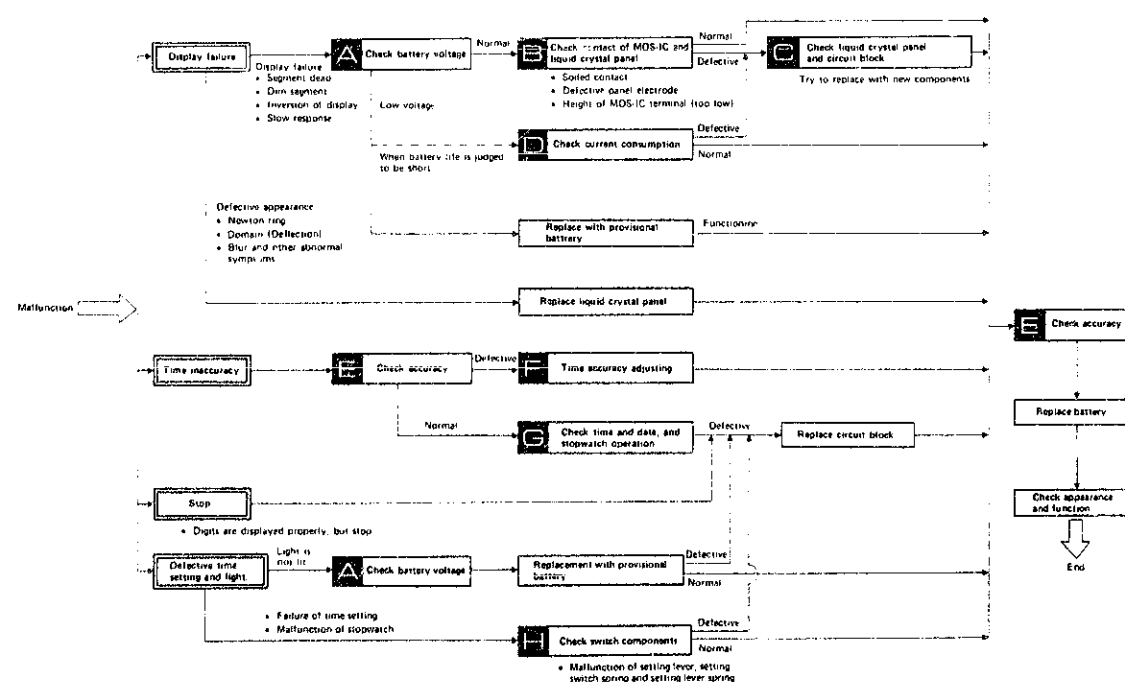

### 3. Segment (Electrode of Liquid Crystal Panel) and MOS-IC output terminal

A complete knowledge of how the segment (Electrode of Liquid Crystal Panel) works with the MOS-IC Output Terminal will provide the proper procedures for checking and adjusting.

#### 1. Segment

- Identification of digits

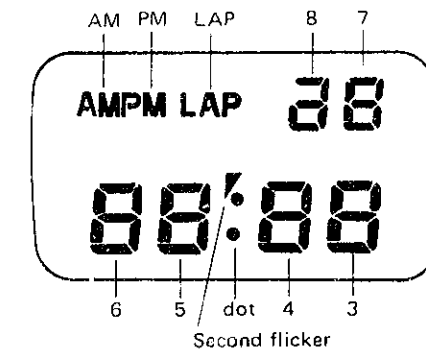

- Identification of segments  
One digit consists of seven (7) segments.

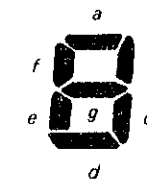

Example:

The segment in mark ○ is called "4d".

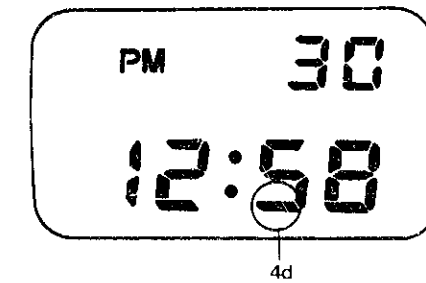

#### 2. Connection with MOS-IC output terminal

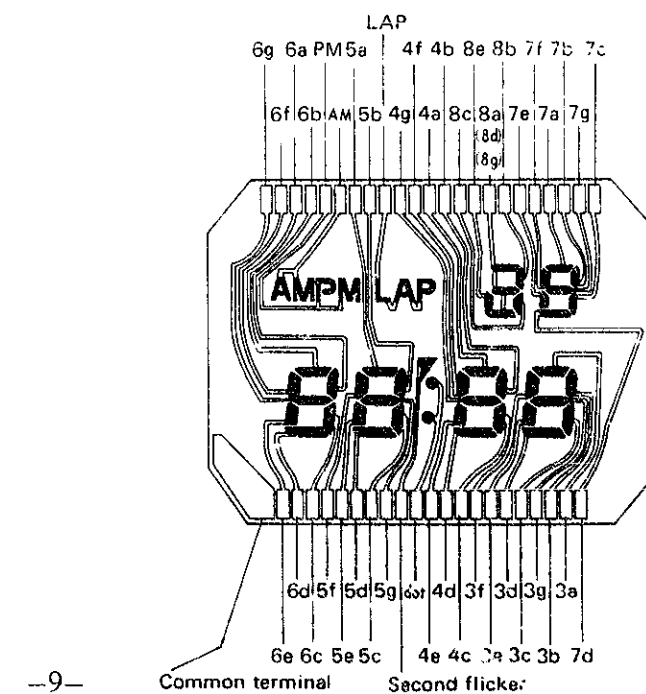
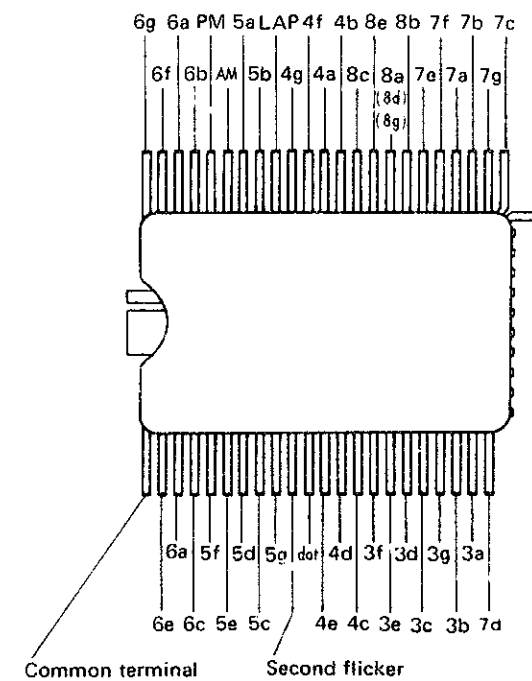

#### 4. Checking and adjustment

##### A Check battery voltage

Use the following procedures to check battery voltage.

- (1) **Set up the tester**  
Range to be used: DC 3 V

(2) **Measuring**

- Probe Red (+) ..... Battery surface (+)
- Probe Black (-) ..... Battery surface (-)

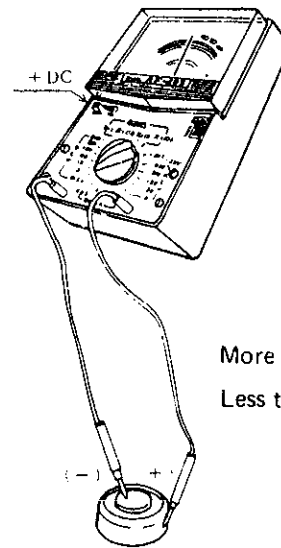

More than 1.5 V . . . Normal  
Less than 1.5 V . . . Defective

##### B Check contact of MOS-IC and liquid crystal panel

Set up the battery with the battery holding spring before checking.

**Remarks:** Do make sure to check the terms of (1) and (2) in "Remarks for battery replacement" on page 3.

After removing the liquid crystal panel, check the conductivity of the electrode of liquid crystal panel and MOS-IC output terminals. (See page 9 for "Segment and MOS-IC output terminal.")

- (1) **Check to see if there is any contamination on the liquid crystal panel electrodes and the MOS-IC output terminal.**

No foreign matter . . . Normal  
Foreign matter . . . Defective  
Wipe off any foreign matter.

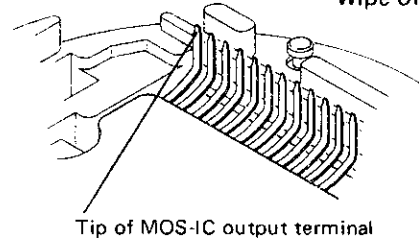
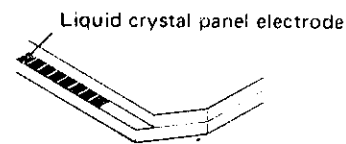

- (2) **Check to see if the level of the MOS-IC output terminal is too low.**

- Raise, with tweezers, the MOS-IC output terminals connected to the segments which fail to light up or are dim.

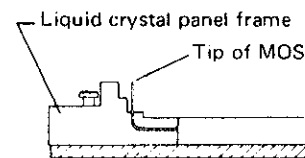
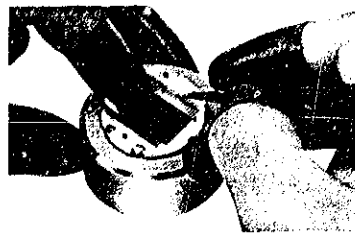

(Raise up the MOS-IC output terminals as high as the top surface of the liquid crystal panel frame.)

- After assembling the liquid crystal panel, check to see if the segments light up.

Light up . . . . . Normal  
Does not light up . . . Defective  
. . . . . Proceed to



##### C Check liquid crystal panel and circuit block

After replacing the liquid crystal panel or the circuit block, check to see if the watch works correctly.

##### D Check current consumption

Check to see if the current consumption is normal.

First of all, pull out the changeover switch before applying the probes.

Check current consumption:

- (1) When the changeover switch is pulled out.
- (2) When the watch functions are working.
- (3) When the stopwatch functions are working.

- Tester

Range to be used: DC 0.03 mA

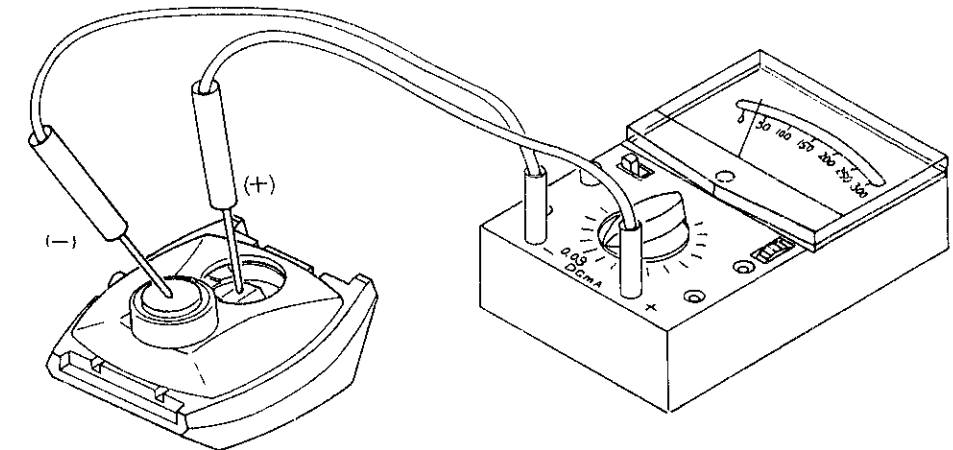

Probe Red (+) ..... Battery lead terminal (+)  
Probe Black (-) .... Battery surface (-)

Less than 6  $\mu$ A: . . . . . Normal  
More than 6  $\mu$ A: . . . . . Defective

##### E Check accuracy

- Use the electric-field detection microphone for QT-10. (See "How to use Quartz Tester QT-10" of the Technical Guide for Cal. 0624A, page 6.)
- Use oscillation detection microphone for QT-100.

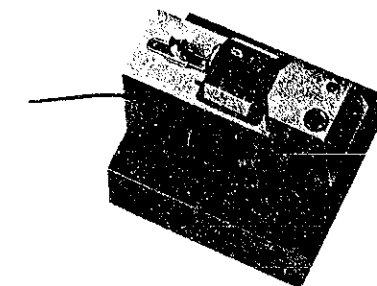
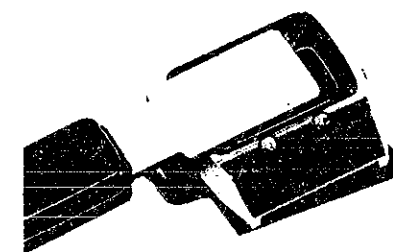

**F** Time accuracy adjusting

Time accuracy of Cal. 0634A is adjusted by turning the trimmer condenser.

• Adjusting method

The watch will gain or lose according to the direction in which the trimmer condenser is turned. Adjustment should therefore be made after ascertaining with the Quartz Tester whether the watch tends to gain or lose.

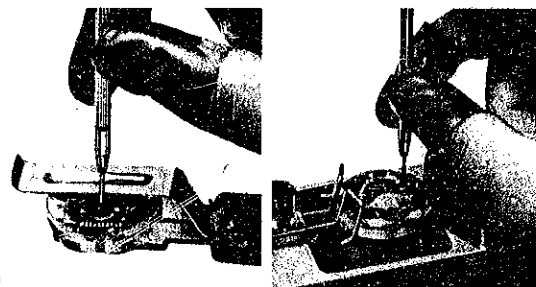

• Note for handling the trimmer condenser

Avoid excessive depressing and turning of the trimmer condenser.

• Function of the Trimmer Condenser

The trimmer condenser consists of a rotor electrode and a stator electrode as shown in the diagram.

Turning the shaft fixed to the rotor changes the overlapped area between the stator electrode and rotor electrode, which in turn changes the capacity of the trimmer condenser.

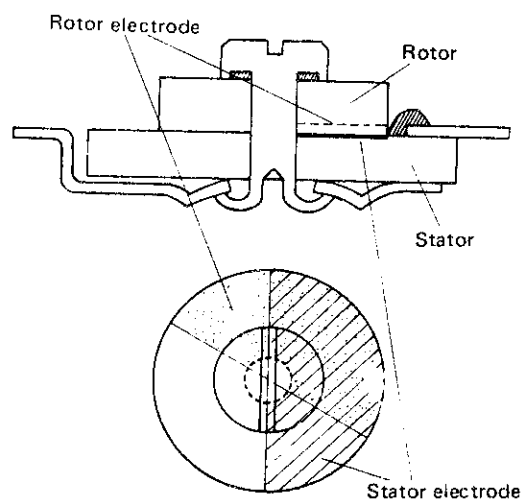

• Change in the capacity of trimmer condenser and the adjusting accuracy rate.

Turning the trimmer condenser changes its capacity as shown in the diagram.

The trimmer condenser has been so adjusted at the factory so as to let the watch gain when it is turned clockwise and vice versa. Whenever adjustment is needed, however, turn the trimmer condenser while examining the gain and loss by the Quartz Tester.

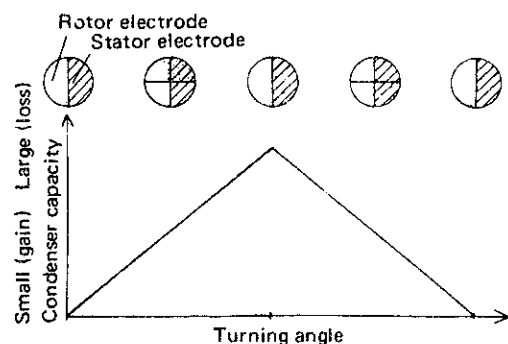

**G** Check time and date setting and stopwatch function

• Watch operation

- (1) Check if the second dots blink exactly at every second, and if one minute is added after 60 blinks.
- (2) Check if the hour and minute setting is made correctly.

(See "How to Set the Time and Date" on page 2.)

- Date Setting condition: More than 31 days.
- Time setting condition: More than 12 hours.
- Minute setting condition: More than 60 minutes.

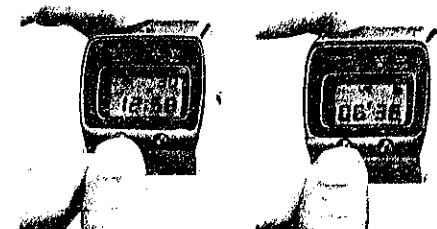

• Stopwatch operation

- (1) Check if the stopwatch functions correctly.

- Check if the following operation functions correctly: Start, Stop, LAP, LAP release and Reset.
- (See "How to use as a stopwatch" on page 3.)

**H** Check switch components

Check to see if the changeover switch and the time adjusting buttons work correctly.

- (1) Check to see if the changeover switch functions correctly.

- Check to see that the thin spring of the setting lever touches the unlock terminal when the changeover switch is pulled out, and that the thin spring of the setting lever is set apart from the unlock terminal when the changeover switch is pushed in.

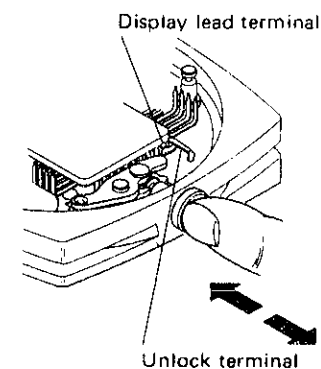

- Make sure that the thin spring of the setting lever comes in contact with the display lead terminal (system changeover terminal) when the changeover switch is pushed in a step further, and that when the pushing-in finger is released, the leaf spring comes off the display lead terminal.

- Make sure that there is no foreign matter (dust, lint) on the contact surfaces of the thin spring of the setting lever, unlock terminal and the display lead terminal. Wipe off dust and lint if there is any.

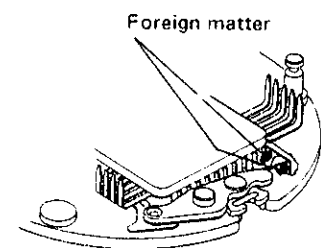

- (2) Check to see if the setting button functions correctly.

- Check to see if the setting switch spring is touching the pin of the circuit board as shown in the illustration. If it touches, correct it with tweezers.

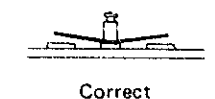
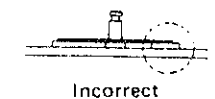

- Make sure that there is not foreign matter (dust, lint) between the setting switch spring and the pin of the circuit board. Wipe off dust and lint if there is any.

