

CITIZEN®

Setting Instructions for Movement Caliber C500 / C506

Contents (click on a topic)

1. Outline
2. Specifications
3. Use of this Watch
 - 3.1. Name of Parts
 - 3.2. Switching Modes
 - 3.3. Using and Setting Time / Calendar
 - 3.4. Using and Setting the Alarm
 - 3.5. Using the Chronograph
 - 3.6. Dive Log Mode
 - 3.7. Dive Alarm Mode
 - 3.8. Diving Mode
 - 3.9. Various Alert Functions
 - 3.10. Special notes
 - 3.11. All Reset
4. Care of Your Timepiece.



OUTLINE

This watch is a diver's watch (200M water resistant) equipped with an electronic depth meter.

SPECIFICATIONS

Caliber No.		C500	C506
Type		Combination quartz watch	
Module size (mm)		ø30.8 x 5.2t	
Time accuracy		±20 Sec/month (at 5°C/41 °F ~ 35°C/95°F)	
Accuracy of depth reading		± (Indicated value x 3% +30cm)	± (Indicated value x 3% + 1ft)
		Conditions: constant temperature and excluding margin of error by sight * Assured accuracy temperature range: +10°C/50°F ~ +40°C/104°F Accuracy of depth reading is affected by surrounding temperatures.	
Accuracy of temperature reading		-5°C/23°F ~ +14°C/57.2°F:within ±3°C/5.4°F +15°C/59°F ~ +40°C/104°F:within ±2°C/3.6°F	
Watch operational temperature range		-10°C/14°F ~ +60°C/140°F	
Time adjustment		Non	
Measurement time		10 Second	
Display functions	Analog display	Time	Hours, Minutes, Seconds
	Digital display	Time	Hours, Minutes, Seconds
		Calendar	Date, Day of the week
		Temperature	-5°C ~ +40°C/23°F ~ 104°F
		Alarm	Hours, Minutes, ON/OFF
		Chronograph	Hours, Minutes, Seconds, 1/100 seconds (24 hour system), Split measurement
		Log memo	Dive month and date Dive number 1~9 Maximum depth..... 1.0m ~ 80.0m (4ft ~ 260ft) Dive time..... 0 min ~ 100 min Dive start time..... Hours, Minutes Dive completed time Hours, Minutes Average depth..... 1.0m ~ 80.0m (4ft ~ 260ft) Lowest temperature..... -5°C ~ +40°C/23°F ~ 104°F * Stored log date memos for the last 4 dives can be recalled
		Dive alarm mode	Depth alarm 1.0m ~ 80.0m/4ft ~ 260ft (to be set in units of 1m/5ft, with the provision to set the number of times of alarms) Dive time alarm 5min ~ 95min (5mintes unit)



Caliber No.			C500	C506
Display functions	Digital display	Dive	Ready for diving	DIV mark flashing
			Present depth	1.0m ~ 80.0m (10 cm units)/4ft ~ 260ft (1ft units) * At depth less than 1.0m/4ft of depth indication is shown Over 80m/260ft, the display is --, --, Dive time (in seconds, measure able up to 100 minutes) or temperature indication (in units of 0.1°C/1°F, between -5°C and +40°C/23°F and 104°F)
			Dive and 0m/0ft display	0.0m/0ft Dive time (in seconds, measure able up to 100 minutes) or Maximum depth (in units of 10cm/1ft, readings up to 80m/260ft max.)
Alarm functions			Daily alarm Dive alarm: Depth alarm Dive time alarm Ascending speed warning alarm	
Additional features			Low battery warning function Alarm monitor	
Battery lifetime			Approx 2 years (after a new battery is installed) under normal use conditions • Number of times of diving: 50/year • One dive duration: 1 hour The life of the battery depends on the use frequency of the alarms of other functions. Futhermore, if the watch is wet in a situation other than diving. While the sensor is activated, watch reduces the battery lifetime, so take care.	



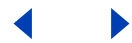

HANDLING INSTRUCTIONS

3-1. Name of Parts

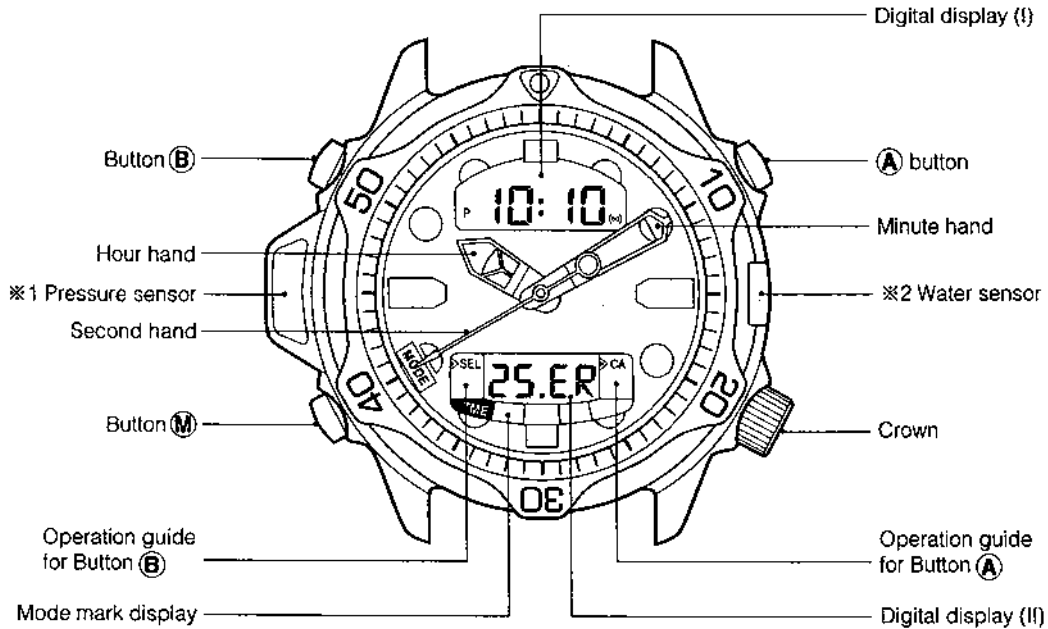

* Never manipulate the crown or press the buttons during a dive, except button (A).
This illustration shows a watch using meters to indicate depth readings.

※1. Pressure sensor

Senses water pressure to measure the corresponding depth.

※2. Water sensor

Whenever this sensor senses traces of water, the watch automatically enters the diving mode with [Ready display] *In addition, the watch contains the temperature sensor as an internal device.







3-2. Switching Modes

From any mode shown in the box below:

1. The watch can be made to enter the diving mode (Ready state) by pressing button **(M)** for 2 seconds or more.
2. The watch will enter the diving mode (Ready state) whenever the water sensor is activated.

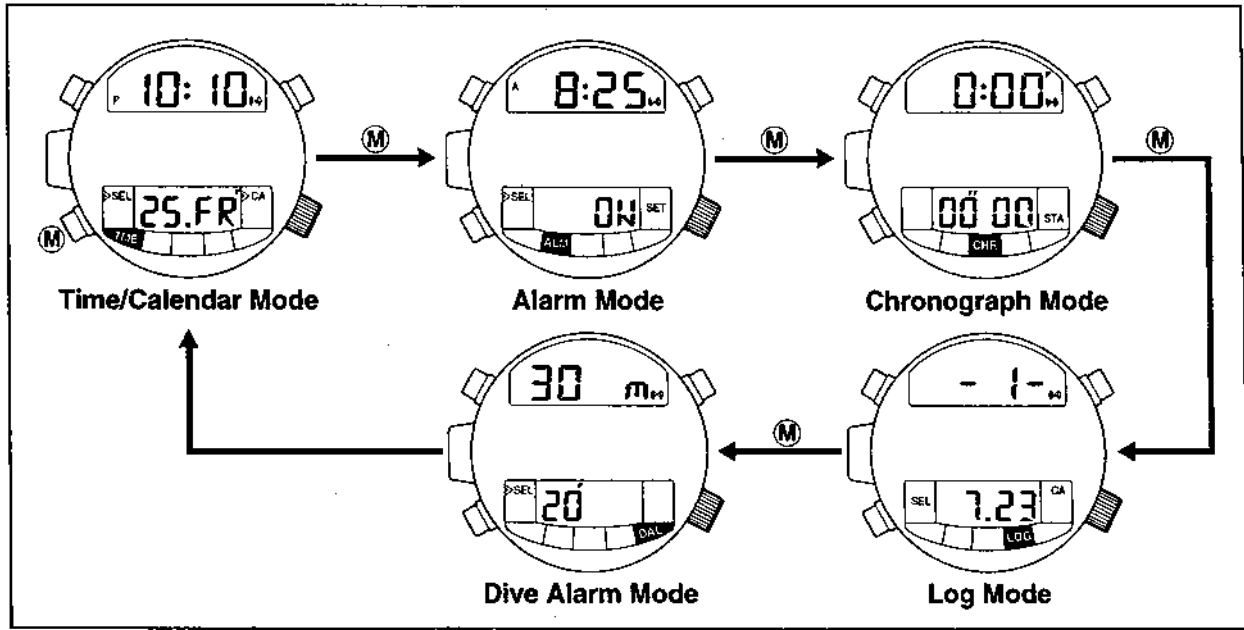

Each time button **(M)** pressed, the display is changed to another mode as shown below.

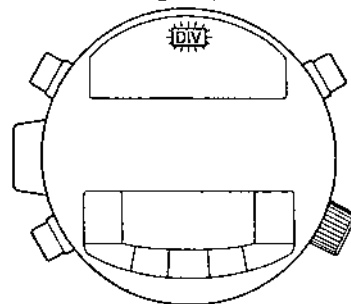

Refer to "DIVING MODE"  or whenever the water sensor is activated.



**Dive mode
(Ready state)**

-  Press once
-  Press 2 seconds or more



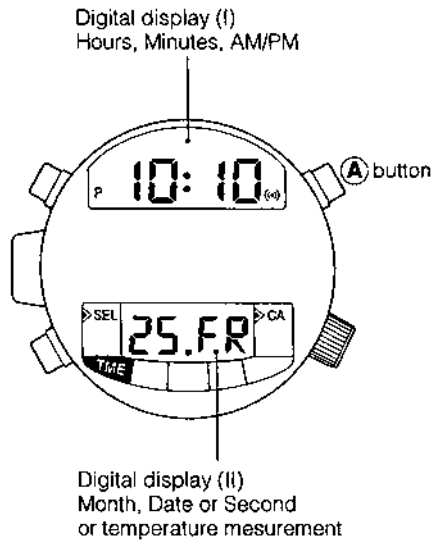

Switching the digital display (II)

1. Press button **(A)** and select month/date or seconds.
2. Press button **(A)** two seconds or more, temperature measurement will display. Please refer to [temperature measurement] on 14 page.

When manipulating the crown...

About the screw lock

1. Always return the crown to its original position and lock it when finished setting the watch.
2. Do not press any of the buttons while the crown is pulled out.
3. Do not pull out or turn the crown when it is wet. Doing so may allow water to seep inside the watch and cause malfunction.

Setting the Time and Calendar

Always perform the digital first. then the Analog setting

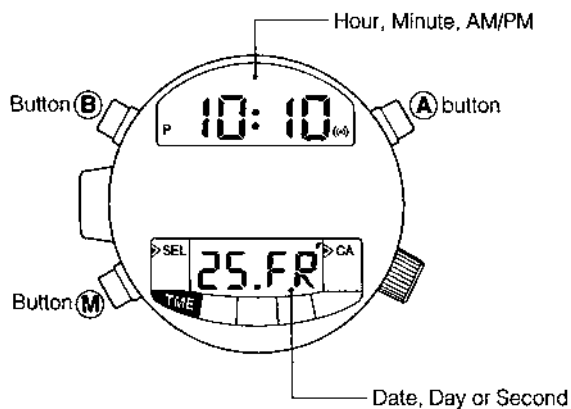

a. Digital setting

Setting the Time and Calendar

1. While in the time mode, press button **(B)** for 2 seconds or more, seconds will flash. and switch to correcting state.
2. While seconds flash, press button **(A)** to reset the seconds to "00" after than seconds start again.
3. When in the seconds correcting state (second flash). Press button **(B)**, the flashing digit will change in the order of second-minute-hour-month-date-year-12/24 hour system, select the digit to correct.
4. Correct the flashing digit by pressing button **(A)** (Press and hold down button **(A)** quick advance the flashing digit.)

- Press button **(A)**, the 12 hour/24 hour will switch alternately
- If the time correct state (flashing digit) remains for longer than 2 minutes, the watch will automatically return to normal time display mode.
- Press button **(M)** while in the time correct state, can be return the watch to normal display mode (Manual return)
- Due to the autocalendar, no correcting at the end of the month is required.



b. Analog setting

Setting the Analog Time

1. Unscrew the crown and pull it out to stop the second hand at "0" position.
2. Turn the crown and position the hour and minute hands 1 minute in advance of the digital time.
3. Press the crown into place when the seconds display of digital time has just come to 0 start the second hand.

3-4. Alarm Mode

When the alarm indicator is ON, the alarm will sound for 15 seconds at the alarm set time, once a day.

Note:

The alarm is disabled during the diving mode, so take care.

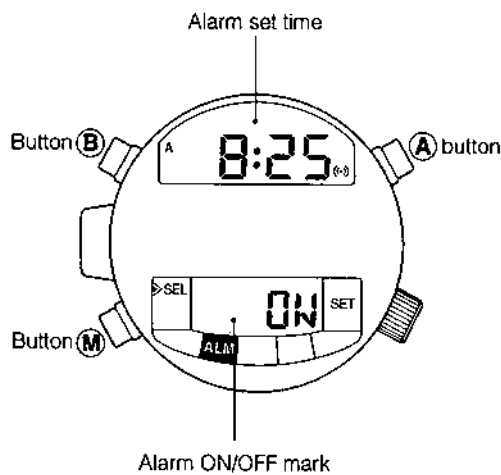

Setting the alarm

1. While in the alarm mode, press button **(B)** for 2 seconds or more, hour will flash, and alarm will indicate ON automatically.
2. While hour flash, press button **(A)** to set the hours.
3. Press button **(B)**, the flashing digit will change in the order hour-minute.
4. Press button **(A)** to set the minutes (Press and hold down button **(A)** to quick advance the flashing digit.)
5. Press button **(B)** or **(M)** to finalize setting.

Alarm 12 hours/24 hours is set in synchronized with the time/calendar mode.

Alarm ON/OFF

Switch the alarm ON/OFF by pressing button **(A)**.

Alarm monitoring

In the alarm mode, while pressing button **(A)**, 2 seconds or more, the alarm monitor will sound.

<Auto-return system>

If the watch is kept the alarm mode for 3 minutes or more, it is automatically switched to the time/calendar mode.

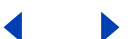

3-5. Chronograph Mode

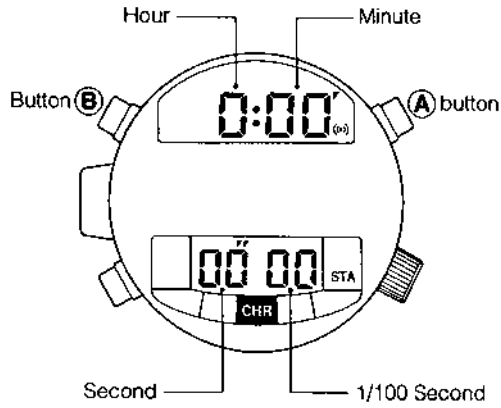

- The chronograph can measure up to 24 hours in 1/100 second.
- The chronograph display automatically returns to 00 and stops.

Using the chronograph

<Standard measurement>



<Accumulated elapsed time measurement>

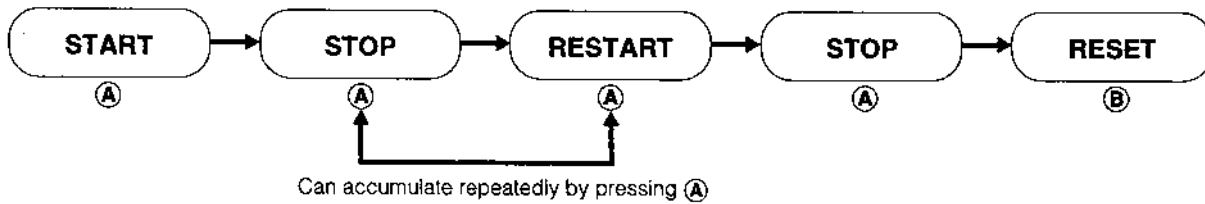

<Split time measurement>

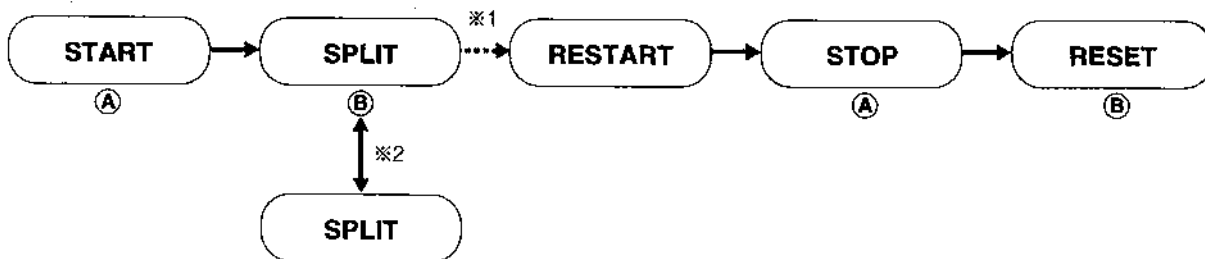

*1 Automatically switched after 10 seconds

*2 When the same button (B) is pressed again during the display of a split time, the next split time is displayed.

Note:

- Change over to another mode is disabled during the chronograph measurement. To change the mode to another mode, make the chronograph measurement stop or reset.

Additional feature

<Auto-return system>

- If the chronograph reset state remains for 3 minutes or more, the watch is automatically switched to the time/calendar mode.



3-6. Log Mode



By pressing button **(M)**, change the mode from chronograph to log mode.
The dive log date can be retained in the watch, counting the last 4 dives.

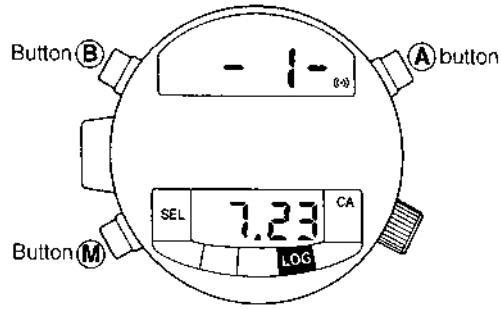

- To recall the log date for the last 4 dives, press button **(B)**. Each time button **(B)** is pressed, the log date is displayed in the order going back from the latest one.
- If the watch is left in the going mode with any date being displayed for 3 minutes or more, it is automatically switched to the time/calendar mode (auto-return)

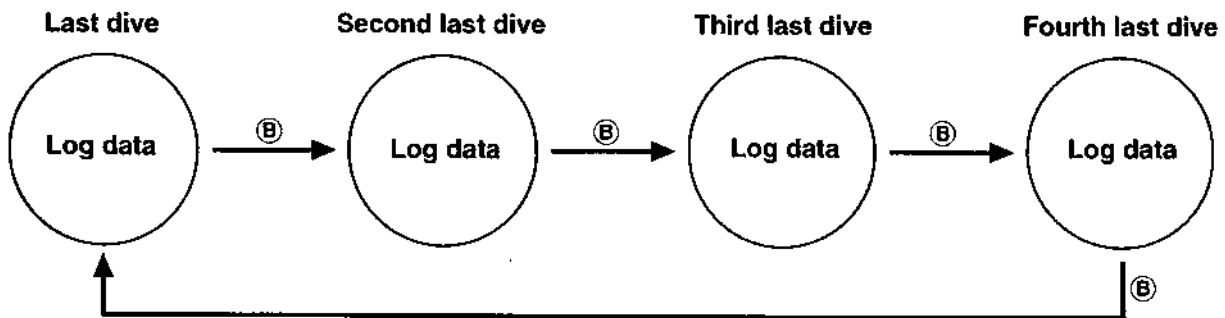

- When you begin a dive, the oldest log data (Fourth last log date) is erased automatically. It is recommended to record the date on a log book, etc.



Every dive makes the watch memorize the following 8 types of log data automatically, which can be recalled in the order of (I), (II), (III) and (IV) as shown below.

- When the watch is switched from the chronograph mode to the log modes by pressing button **(M)**, log (I) is displayed.
- Each time button **(A)** is pressed, the log display is changed to the next in the order of (I), (II), (III) and (IV).
- Only when log (I) is displayed, the display is automatically changed to log (II) after 2 seconds without pressing button **(A)**.

On rare occasions, even if the water sensor senses traces of water and the watch is switched to the dive mode (dive ready state), however, log (I) display may fail to change to log (II) display automatically.

In case this happens, press button **(A)** change the display.

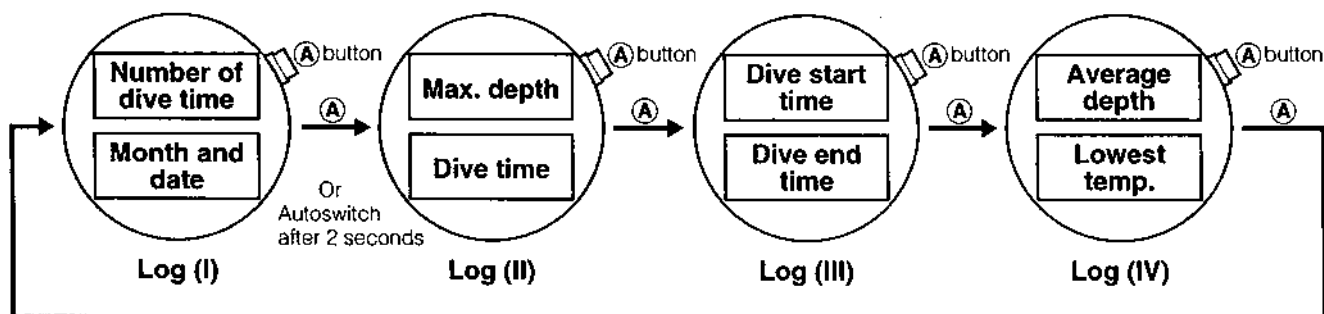

- 1. Number of dives:** The number of dives performed in a particular day. A maximum of 9 dives can be counted. Counting is initiated day by day.
- 2. Dive month and date:** Date and month when diving is performed.
- 3. Maximum depth:** The maximum depth that was reached in one diving.
- 4. Dive time:** Total time when the diver remains deeper than the depth of one meter.
In the diver goes again into the water deeper than 1m (4ft) within 10 minutes after the diving depth becomes shallower than 1 m (4ft), the dive time counting resumes at the time when the measurement is stopped and the accumulative time is recorded successively. Measurement is taken in units of seconds and up to 100 minutes at maximum, when the maximum is reached, the measurement starts again with zero.
- 5. Dive start time:** The time when a dive depth reaches 1m (4ft).
- 6. Dive end time:** The time when the dive depth becomes shallower than 1m (4ft).
- 7. Average depth:** Average depth in one dive.
- 8. Minimum temperature:** The minimum temperature recorded in one dive.

These log data are displayed as log (I), (II), (III) and (IV) separately.



To delete all log data

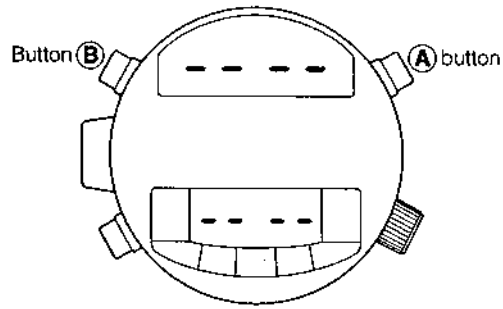

Depress button **A** and button **B** together for 2 seconds or more and log data will be deleted.

In case the depth indication flashes

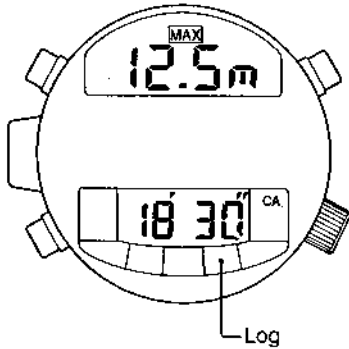

This signifies that the log data is faulty.

In case ER (error) is shown

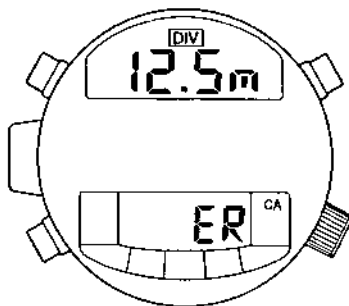

This signifies that log data is faulty.

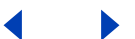

3-7. Dive Alarm Mode

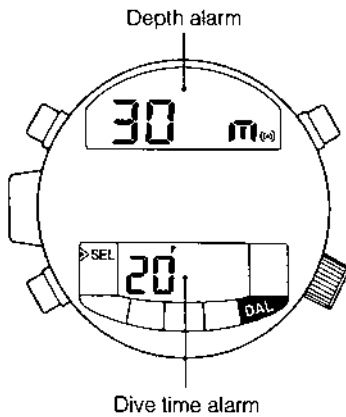

Note:

The alarms may be hard to hear depending on the surroundings (such as the sound of air bubbles) and the watch wearing conditions, so take care in using the alarm.

The following two alarm functions are provided as dive alarms used in this watch.

- 1. Depth alarm function:** When the set depth is reached during a dive, the alarm will beep for 15 seconds. The depth alarm setting range is 1m to 80m/4ft to 260ft (units of 1m/4ft) If you continue to dive deeper than the set depth alarm, every minutes the alarm can be activated repeatedly. The number of times the alarm will be activated can be chosen from 0 to 5 or every minutes.
 * The number of times the alarm will sound during one dive is preset on the watch. For example, if you set the number of times at "1", the alarm sounds only once during one dive.
- 2. Dive time alarm function:** When the set time comes after starting a dive, the alarm will beep for 15 seconds. This alarm will not be repeated.

If the ascending speed is over 1.5m (5ft) for 10 seconds during a dive, the ascending speed alarm will beep for the duration of at least 10 seconds to alert the diver of overspeed.

Setting the Depth Alarm/Dive Time Alarm

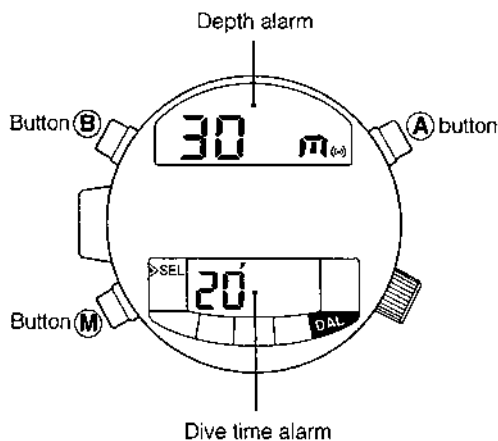

- 1) Press button **(B)** for 2 seconds or more to switch to the DIVE ALARM correcting mode (the preset depth value starts flashing). At this time, the digital display (II) change from the dive time alarm display to the display for the number of times the alarm will be activated.
- 2) Set a diving depth at which you want the alarm to sound by pressing button **(A)**. Each time button **(A)** is pressed, the depth setting becomes deeper by 1m (4ft). A maximum setting is 80m (260ft). With the maximum exceeded, the setting is returned to 1m (4ft).
 - * Rapid advance of settings is made by pressing and holding down the button **(A)**.
- 3) Press button **(B)** to switch to the number of times of alarm occurrences correcting mode (the preset number of times starts flashing).
- 4) Change and set the number of times of alarm occurrences by pressing button **(A)**. The display for the alarm frequency is changed and cycled in the following order:
ON → OFF → 1 → 2 → 3 → 4 → 5.
ON: The depth alarm will beep every minute when the diving depth is deeper than the set depth
OFF: Depth alarm is disabled.
- 5) Press button **(B)** to switch the dive time alarm display to the correcting mode (the preset value for dive time alarm starts flashing).
- 6) Change and set the dive time alarm time by pressing button **(A)**. The display for dive time alarm is changed and cycled in the following order:
-- → 05 → 10 → 15 → 95 → --.
* With the display of "--", the dive time alarm is disabled.
- 7) Press button **(B)** or **(M)** to finish the setting procedure.

Dive Alarm Monitor

By keeping button **(A)** depressed, repetitive alarm monitoring at 4 second intervals can be performed in the following order: depth alarm → dive time alarm → rapid ascent warning alarm.

3-8. Diving Mode



When any in other mode, the watch will enter the diving mode with the display changing to [ready display] by pressing button **(M)** for 2 seconds or more. If [ready display] put in this way is allowed to stand for about 60 minutes, the display automatically returns to the preceding mode.

One of the following three displays is shown in the diving mode.

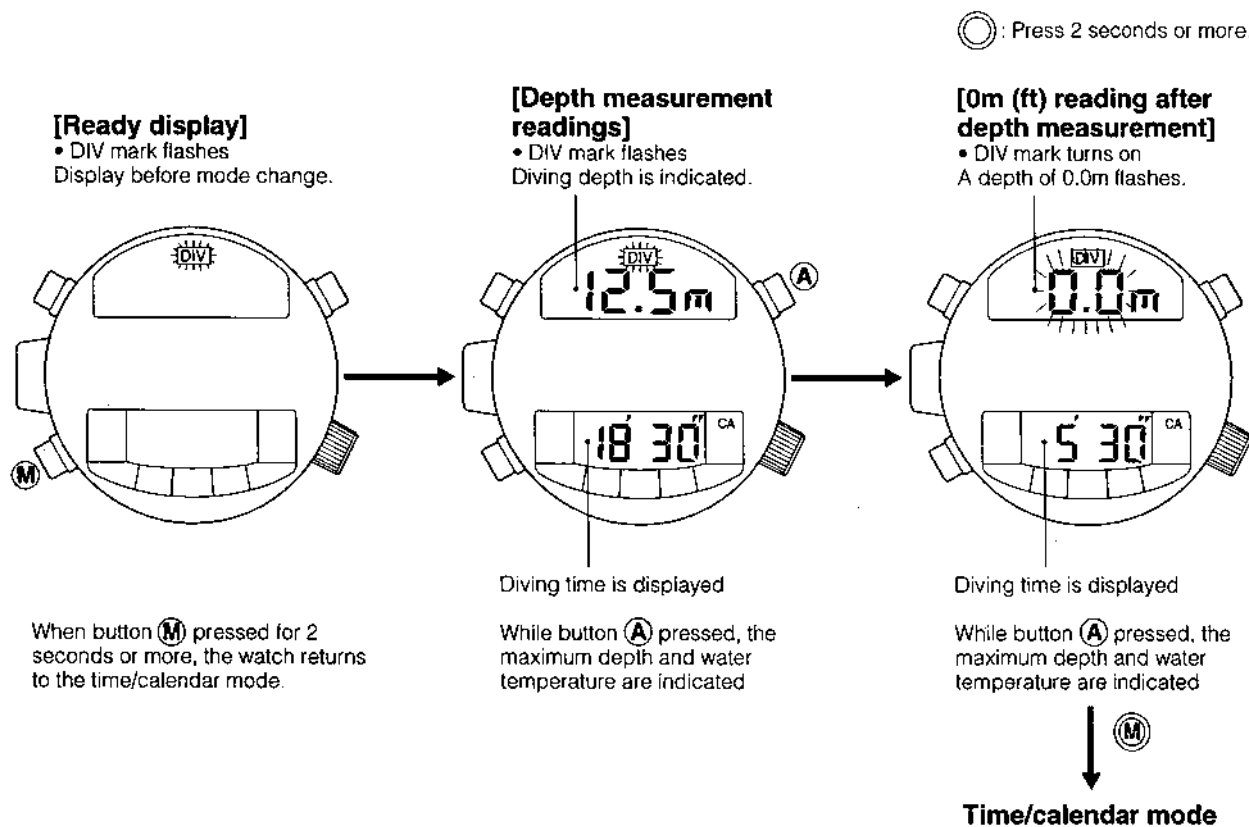

Additional feature

<Water sensing function>

This watch is provided with a water sensor. Whenever this sensor senses traces of water in any other mode display, the watch automatically enters the diving mode with [ready display].

- * During the chronograph measurement, however, the mode change is disabled. When the moisture is removed, the watch is released from the [ready display].

1. When a depth of 1m (4ft) is reached after you begin diving with the watch displaying [ready display], the display will automatically change to [depth measurement readings].
 2. When the diving depth becomes less than 1m (4ft), the display will automatically change to [0m (0ft) reading after depth measurement].
 3. If button **(M)** is pressed for 2 seconds or longer with the display of [0m (0ft) reading after depth measurement], then the watch return to the time/calendar mode.
- If the display of [0m (0ft) reading after depth measurement] is allowed to stand for 10 minutes or longer, the watch automatically enters the time/calendar mode.
- If the diver dives again deeper than 1m (4ft) within 10 minutes, the dive time counting resumes.





Depth Measurement

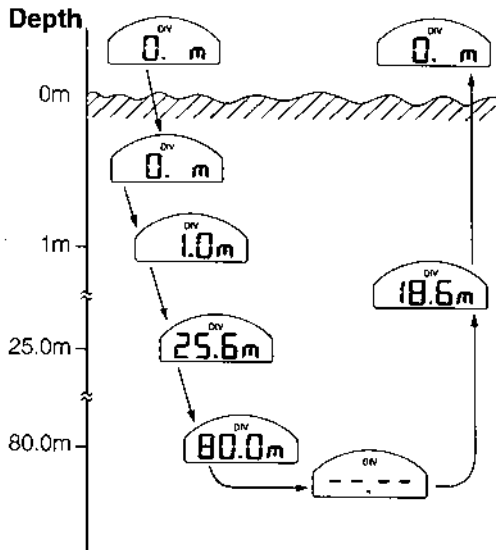

1. Depth measurement

The diving depth is measured every second, and the reading of the depth is displayed on the watch.

Units of depth measurement: 0.1m (1ft)

Range of measurement: 1.0m to 80m (4ft to 260ft)

When diving depth is less than 1m (4ft): the display will be 00.0m (000ft).

When diving depth exceeds 80m/260ft: display will be ---m (---ft)

In case the ER (Error) displayed depth reading flashes: This means that depth measurement is faulty.

Dive time measurement

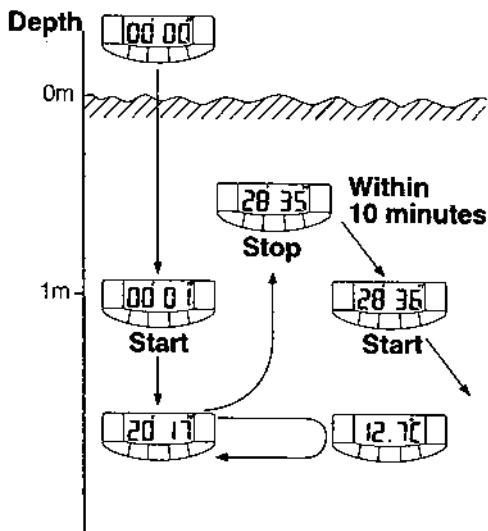

2. Dive time measurement

When the diving depth reaches to 1.0m (4ft), the dive time measurement will start. It stops when the depth becomes less than 1.0m (4ft).

If the diving depth becomes deeper than 1.0m (4ft) within 10 minutes after the end of the dive time, the dive time resumes at the time when the measurement is stopped and the accumulative time is recorded successively.

3. Water temperature measurement

Water temperature measurement starts 1 minute after a depth of 1.0m (4ft) is measured and displayed. Subsequently, temperatures will be measured very minute.

Units of water temperature measurement: 0.1°C (1°F)

Range of measurement: -5°C to +40°C (23°F ~ 104°F)

Before temperature measurement and out of the measurement range: the display will be ---°C (---°F)

* While button **A** stays depressed during the display of the diving time, the display shows water temperature readings, not the diving time.





3-9. Various Alert Functions

This watch is provided with the following alert functions.
These alerts are recommended to be used to increase the safety in diving.

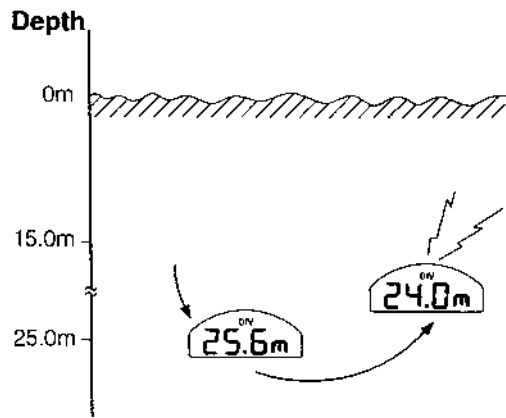

1. Ascending speed warning

If the ascending speed exceeds 1.5m (5ft) in 10 seconds during a dive, the alarm will sound for more than 10-seconds as the ascending speed alert.

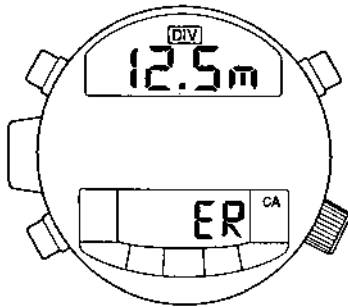

2. Abnormal depth alert

In case of rapid change in depth over 4m (13ft) for one second, the flashing ER (Error) appears on the digital display (II).

If the pressure sensor is faulty, ER (Error) is shown even when the watch is used on land.

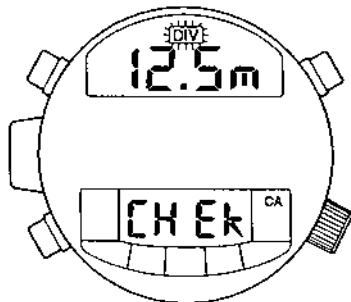

3. Water sensor check alert

Although the water sensor is activated and the watch enters the diving mode with [ready indication], if one hour or longer is elapsed without any action, CHECK appears on the digital display (II) as the water sensor check alert.



3-10. In Case of the Following

The second hand goes at 2-second intervals.

The action occurs when the battery run down warning is activated, which warns the user that battery will run down soon.

In this case, replace the battery in advance of its lifetime. (The watch keeps correct time during this occurrence.) However, when this warning function is on, other functions are inhibited as follows:

1. All alarms do not sound.
2. Changeover to the diving mode [Ready display] is disabled.
3. When in the diving mode with [Ready display], changeover to [Depth Measurement Readings] is disabled.
4. With [Depth Measurement Readings] displayed on the watch, the dive alarms do not sound, stop diving immediately.
5. With [Temperature Measurement Readings] active on the watch, the watch returns to the pre-state.
6. In case of the water sensor check alert display, the alert display is disabled.

- **Changeover cannot be performed from the diving mode [Ready display] or [0m (oft) Reading after Depth Measurement] to the time/calendar mode.**

- **In case the depth reading is one meter or more, though the watch is used on land.**

In this case, all reset should be performed by referring to page 17. If the watch display is changed to the pre-state of the diving mode [Ready display] or to the time/calendar mode when the crown is pulled out, there is no problem.

If the mode change cannot be made, all reset should be performed (see page 17)

- **Digital display malfunction**

Should strong impact or static electricity be applied to the watch by accident, the digital display may malfunction at times. If this occurs, all reset should be performed by referring to page 17.

- **After battery replacement**

After the battery is replaced, be sure to perform all reset by referring to page 17. If not done so, the watch does not operate properly, making correct displays. (Note 1)

Note 1

All reset operation will erase all the stored data.

3-11. All Reset

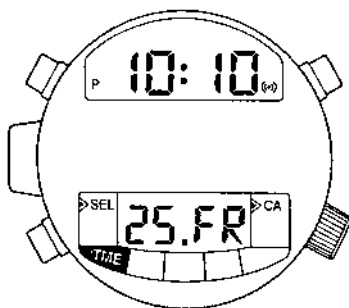

1. Pull the crown out.
2. Press all three buttons simultaneously and release.
If the alarm sounds 2 times, all reset is completed.

Because all the stored data are erased after all reset, setting for each mode should be performed again correctly.

PRECAUTIONS ABOUT CARE AND HANDLING OF WATCHES

TEMPERATURE CARE

Avoid temperature extremes. Exposing your watch to high temperatures, such as placing it on the dashboard of a vehicle or use in a hot tub, may cause the watch to malfunction, shorten battery life or damage certain components. Leaving the watch in extreme cold temperatures may cause irregular timekeeping until the watch returns to normal operating temperature.

SHOCK-RESISTANT

The watch may be worn while playing golf or other activities, but avoid severe shocks such as dropping it on a hard surface.

MAGNETIC-RESISTANT

No problem should occur from using the watch around ordinary household electric appliances such as TV sets or stereos. Keep away from magnets.

CHEMICAL/GAS RESISTANT

Do not expose the watch to chemicals or gases for long periods.

WATCH CLEANING

Stains, waterspots and accumulated dirt on the case, crystal or band should be removed with a soft cloth to prevent damage and premature wear.

HANDLING OF WATER-RESISTANT WATCHES

Although water-resistant watches are warranted, steps should be taken to avoid damage that may result from accidents or mishandling:

- Do not operate the crown or push-button in the water or while the watch is wet. Tighten screw lock crown completely.
- Should the watch become immersed in water, dry it off right away. If the watch comes in contact with salt water, be sure to rinse it thoroughly in warm fresh water to remove any trace of salt.
- If a watch is wet from cleaning or by accident, never store it in a closed container. It should be dried immediately or taken to a watchmaker or jeweler if moisture is inside the case to prevent damage from rust.
- Vital components necessary to resist the entrance of moisture deteriorate with time and use. Gaskets, crowns and other materials should be replaced every year or two to ensure

that water resistant quality remains at factory specifications.

CARE FOR METAL BRACELETS

To extend the life and maintain the good appearance of the metal watch bracelet, the following recommendations are given:

- Be aware that since the watch and bracelet is worn next to the skin, it collects dust and perspiration and becomes soiled if not cleaned regularly. This is particularly true of the inner parts of the links or mesh of the bracelet.
- Soil and rust, when present in a bracelet, are dissolved by perspiration and can cause staining of cuffs and irritation of the skin in some instances.
- Heavy perspiration should be wiped off the watch and bracelet with a soft dry cloth. The bracelet should be cleaned occasionally by using an old toothbrush and warm soapy water after which the soap is thoroughly rinsed with clear water and the bracelet dried completely. The foregoing manner of cleaning should not be done if the watch is not water-resistant but should instead be done by your jeweler.





CARE FOR STRAPS

LEATHER

- Heavy perspiration, if not removed from a leather strap, can wash out the natural oils and cause the leather to become dry and deteriorate. Any moisture should be blotted with a soft dry cloth or paper towel and the strap allowed to dry naturally.
- Salt residue and soil can be removed from the leather by cleaning with a dampened soft cloth and mild soap or saddle soap.
- Occasionally, the inside surface of the strap should be cleaned by using a soft cloth dampened with alcohol.
- The strap should always be worn a little loosely (one finger space between wrist and strap) to allow air to circulate thus causing any moisture to evaporate.

RUBBER

- Rubber straps should be washed frequently with mild soap and warm water using a soft brush.
- Thorough cleaning, using the same method, should especially be done after use in salt water.
- Solvents, oils, perspiration, tanning lotion and salt can cause rubber to deteriorate if not removed.

Marking on the Dial	Marking on the Caseback	 Face washing, splashes, sweat, raindrops, etc.	 Swimming	 Skin diving (diving without air tanks)	 Scuba diving (diving with air tanks)	Water-resistant characteristics
NONE	NONE	NO	NO	NO	NO	Non water-resistant watch and must be kept away from water.
NONE	WATER RESIST	OK	NO	NO	NO	An ordinary water-resistant watch and can withstand splashes, sweat, rain-drops and etc. for daily life use.
WR100M WR10bar WR150M	WATER RESIST	OK	OK	OK	NO	For frequent use with water. It is not specially designed for scuba diving.
WR200M	WATER RESIST	OK	OK	OK	OK	For skin and scuba diving. Usable up to the respective indicated depths.



The water-resistant quality of our timepieces is offered in varying degrees depending on the model. This ranges from non-water resistant models to those suitable for SCUBA diving. Water resistance of our timepieces is measured in BAR or Barometric Pressure. Each BAR of pressure is equal to 14.5 pounds per square inch of pressure.

Water resistance is measured when the watch is at a static, or motionless state. As the watch is moved in water, such as from the motion of swimming, pressure is added from velocity. While you may be swimming in a pool at surface level, the watch may be experiencing forces equal to that of 100 feet of water pressure (3 BAR). Diving into a pool can cause forces on the watch to exceed those pressures. As such, you should always allow a margin of safety when exposing your watch to moisture. Never "push the limit" of the degree of water resistance of your timepiece.

A primary factor to keep in mind about water resistance is that periodic maintenance is needed to maintain original factory specifications for water resistance. When a watch is new, it meets specifications for water resistance as indicated on the case back. However, as the watch ages, the gaskets that seal the watch become dry and brittle, diminishing its water resistant quality. Exposure to environments such as chlorinated pools, salt water or soaps from showering can accelerate drying of the gaskets. We recommend that the gaskets be changed at least every 18 to 24 months to maintain the water resistant quality of your timepiece. If the watch is frequently exposed to chlorinated pools, soaps salt water, etc., we recommend that the gaskets be changed on a yearly basis.

From time to time, you may notice condensation that appears then goes away after a short period of time. This is a normal occurrence and happens primarily from sudden temperature changes. When there are sudden temperature changes such as entering a cool building from the hot out of doors, or jumping into pool on a hot day the watch may fog. Conversely, if you go to the cold outdoors from a warm building, fogging may occur. As long as the fogging clears in a short period of time, there is no need for concern.

Be sure the crown is completely pushed in prior to any contact with moisture. If your model is equipped with a screw down crown, be sure it is properly seated against the case. Do not operate the crown or any push button when the watch is wet as this may allow the entrance of moisture. . If at anytime, you notice moisture in your timepiece that does not clear in a short period of time, you should send your timepiece as soon as possible to the nearest Authorized Service Center for inspection.

You can determine the level of water resistance of our watches from the markings on your case-back. Additionally, models that are water resistant to 100 or 200 meters have an indication on the dial as well. The case-backs and dials are normally marked as follows:

The case back has no indication of water resistance

This indicates the watch is a non water-resistant model and is not designed for contact with moisture at all. Caution should be exercised to avoid any contact with moisture, such as when washing your hands or from a rainstorm.

"Water Resist"

This watch is designed to withstand water from accidental splashing, such as from washing your hands or rain. Any submersion into water may result in the entrance of moisture.

"Water Resist 10BAR" or "W.R. 10BAR", Dial marked "WR100"

This watch is designed to withstand water pressure up to 333 feet. This includes water exposure from accidental splashing and rain, but also from showering, swimming in a pool and snorkeling. Be sure to rinse the watch with fresh water after exposure to a chlorinated pool, salt water, soaps, etc. After rinsing with fresh water, be sure to dry the exterior with a soft cloth.

"Water Resist 20BAR" or "W.R. 20BAR", Dial marked "WR200"

This watch is designed to withstand water pressure up to 666 feet. This includes all exposure to water up to and including recreational SCUBA diving. Be sure to rinse the watch with fresh water after exposure to a chlorinated pool, salt water, soaps, etc. After rinsing with fresh water, be sure to dry the exterior with a soft cloth.

Special Note about Jacuzzis and Hot Tubs

The various components used in the manufacture and assembly of your watch expand at various rates. This results in a loss of the sealing capabilities of gaskets, which may allow moisture to enter. In addition, heat from these sources can cause deformation of certain materials leading to mechanical failures. For these reasons, you should remove your watch before entering a hot tub or Jacuzzi.

